

ZER^{PRO}ATP[®]

ACTIVE TRANSFER PLATE

Movex[®]
www.movexii.com

EM
ENGINEERING MANUAL

APPLICATION CONSIDERATIONS.

The proper selection and application of Movex® products and components, including the related area of product safety, is the responsibility of the customer. Operating and performance requirements and potential associated issues will vary appreciably depending upon the use and application of such products and components. The scope of the technical and application information included in this publication is necessarily limited. Unusual operating environments and conditions, lubrication requirements, loading supports, and other factors can materially affect the application and operating results of the products and components and the customer should carefully review its requirements. Users of our products should make their own tests to determine the suitability of any product for their particular purposes.

Any technical advice or review furnished by Movex® with respect to the use of products and components is given in good faith and without charge, and Movex® assumes no obligation or liability for the advice given, or results obtained, all such advice and review being given and accepted at customer's risk.

For a copy of our Standard Terms and Conditions of Sale, Disclaimers of Warranty, Limitation of Liability and Remedy, please see our web site www.movexii.com or contact our Customer Service.

These terms and conditions of sale, disclaimers and limitations of liability apply to any person who may buy, acquire, or use any Movex® product referred to herein, including any person who buys from a licensed distributor of these branded products.

The applicable Movex® product catalogs and installation/maintenance bulletins must be used only by qualified individuals familiar with Movex® products; these documents contain important precautions and other information intended to reduce the risk of bodily injury. Refer to these documents before specifying, installing, operating, or servicing equipment.

Incorrect and/or incomplete data could cause the selection of improper components, potentially resulting in bodily injury. Movex® makes no warranties, express or implied, of merchantability or fitness for a particular purpose.

Movex® will not be liable for direct or indirect incidental, consequential, or punitive damages arising from the use or inability to use this any of the information made available, including but not limited to product literature, selection programs, and interchange guides. Movex® reserves the right to correct, modify, update and/or enhance these documents at any time without notice or penalty, including but not limited to pricing, technical data, etc. Most updated documents can always be found on the website. For more technical information, contact our Technical Support.

© Copyright Movex S.p.A. 2022

The contents of this manual are the copyright of the publisher and may not be reproduced (even extracts) unless permission is granted. Every care has been taken to ensure the accuracy of the information contained in this publication, but no liability can be accepted for any error or omission. **Catalogue N° M999584**

INTRODUCTION	05
VERSIONS	06
SPEED CALCULATION	
Mini motor version (standard)	08
External motor version (power)	09
Keyed shaft version	10
INSTALLATION	11
GENERAL TABLE WITH NOSEBARS / ROLLERS	13
TRANSFER LENGTH WITH NOSEBARS / ROLLERS	
520 FT with NoseBars Ø19	14
520 LBP with NoseBars Ø19	15
520 PRO LBP with NoseBars Ø19	16
525 FT with NoseBars Ø19	17
530 PRO LBP with NoseBars Ø19	18
550 FT with Rollers Ø40	19
551 FT with Rollers Ø40	20
551 LBP with Rollers Ø40	21
551 PRO LBP with Rollers Ø40	22
553 FLEXTOP with Rollers Ø50	23
556 FT with Rollers Ø50	24
600 FT with Rollers Ø60	25
GENERAL TABLE WITH SPROCKETS	26
TRANSFER LENGTH WITH SPROCKETS	
520 FT with Sprockets	28
520 LBP with Sprockets	29
520 PRO LBP with Sprockets	30
525 FT with Sprockets	31
530 PRO LBP with Sprockets	32
550 FT with Sprockets	33
551 FT with Sprockets	34
551 LBP with Sprockets	35
551 PRO LBP with Sprockets	36
553 FLEXTOP with Sprockets	37
556 FT with Sprockets	38
600 FT with Sprockets	39
820 FT with Sprockets	40
821 LBP with Sprockets	41

INSTALLATION WITH EXTERNAL TRANSMISSION	42
PERSONAL PROTECTIVE EQUIPMENT	43
DO'S AND DON'TS	44
MAINTENANCE	
General maintenance instructions	45
Installation on the line	46
Inspection	47
CLEANING	48
TROUBLESHOOTING	49
MATERIAL	
LFA - LFB	50
MX	51
FREQUENTLY ASKED QUESTION	52



Unique design

It solves traditional transfer plate issues.



User-friendliness

Easy installation and interchangeability.



Short transfer connection

It works perfectly with small products.



Minimized maintenance

Zero ATP™ Pro doesn't require maintenance.



Saving (Energy, resources, time)

Fewer resources and time employed.



Safer design

Minimized the possibility of injuries.

General products features

Belt series	510 FT
Belt width	6inch ÷ 24inch
Transfer length	80 or 150 mm
Transmission	Mini motor or Keyed shaft
Material	LFA, MX or LFB
Max working load	3000 N/m

Plug and play solution

- Self-tensioning
- Compact design
- Easy installation
- Maintenance free
- Low voltage
- Easy integration

Simultaneous transport of:

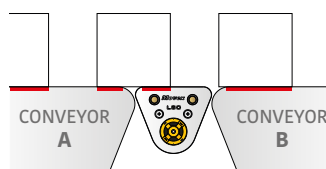

LIGHTWEIGHT & SMALL GOODS

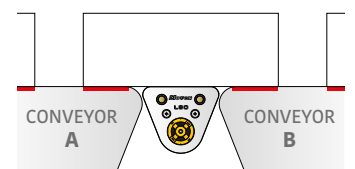

HIGH LOAD & BIG GOODS

VERSION A - WITH MINI MOTOR

Length 80 mm

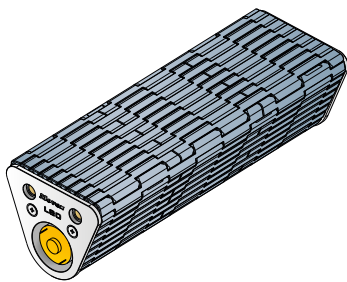
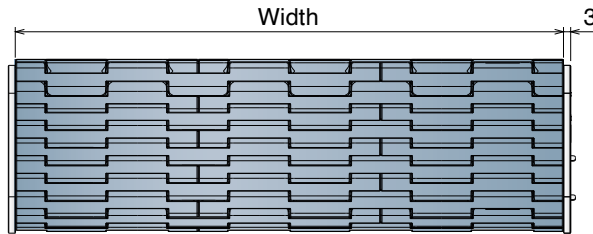
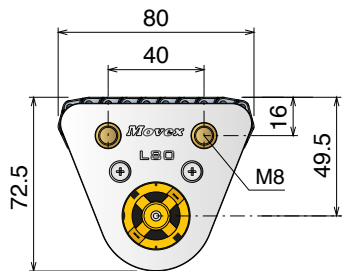

Series	*Material	Width	Version
5336	*	0006	A
5336	*	0009	A
5336	*	0012	A
5336	*	0015	A
5336	*	0018	A
5336	*	0021	A
5336	*	0024	A

*Wider version on request

Length 150 mm

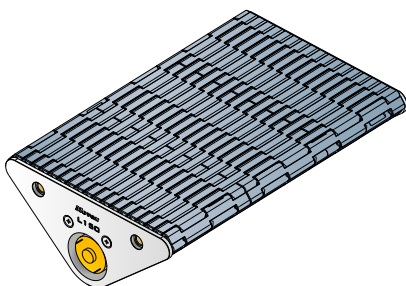
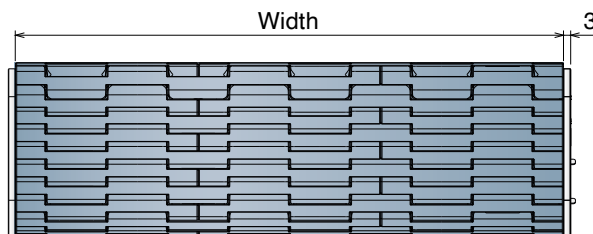
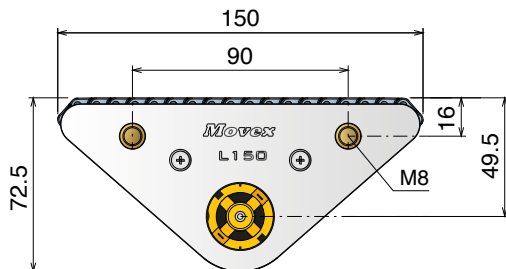

Series	*Material	Width	Version
5338	*	0006	A
5338	*	0009	A
5338	*	0012	A
5338	*	0015	A
5338	*	0018	A
5338	*	0021	A
5338	*	0024	A

*Wider version on request

LFA | Low friction Acetal

Material information, page 50

MX | Performance PBT

Material information, page 51

LFB | Low friction Acetal

Material information, page 50

VERSION B - WITH KEYED SHAFT

Length 80 mm

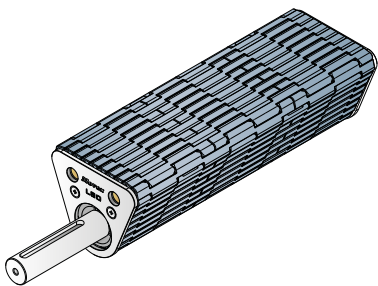
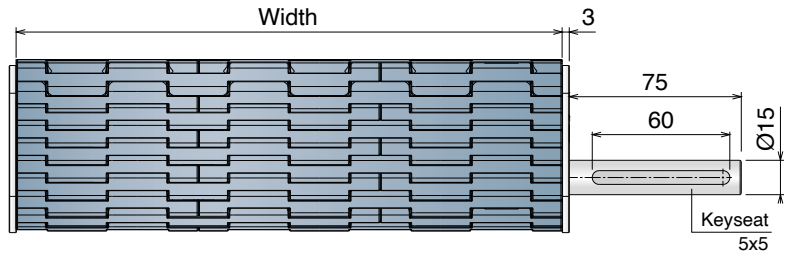
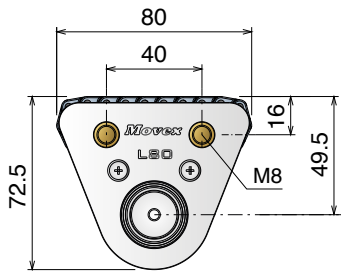

Series	*Material	Width	Version
5336	*	0006	B
5336	*	0009	B
5336	*	0012	B
5336	*	0015	B
5336	*	0018	B
5336	*	0021	B
5336	*	0024	B

*Wider version on request

Length 150 mm

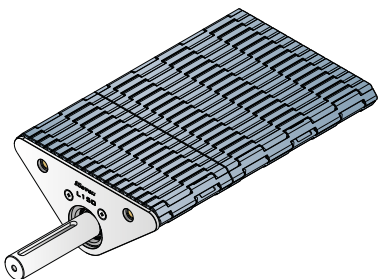
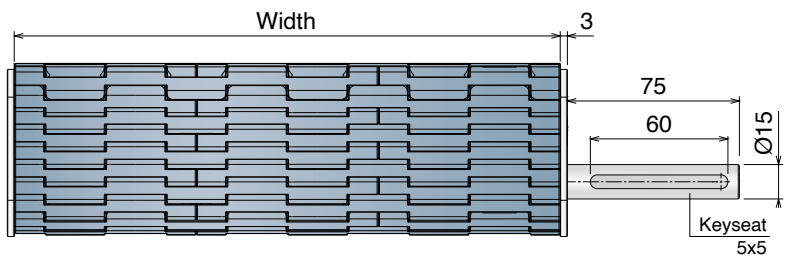
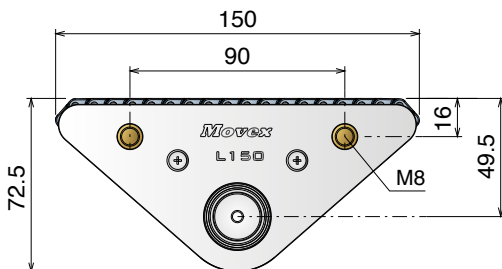

Series	*Material	Width	Version
5338	*	0006	B
5338	*	0009	B
5338	*	0012	B
5338	*	0015	B
5338	*	0018	B
5338	*	0021	B
5338	*	0024	B

*Wider version on request

LFA | Low friction Acetal

Material information, page 49

MX | Performance PBT

Material information, page 50

LFB | Low friction Acetal

Material information, page 49

MINI MOTOR VERSION (STANDARD)

Zero ATP® PRO version A is provided with the mini motor installed internally; this will make the Zero ATP® PRO compact and easy to be installed into new or exiting lines.



Operating relative humidity 20% - 85%
Operating temperature range -10°C - +60°C

Technical specifications

Output Speed	84 rpm
Supply Voltage	6 - 15 V dc
Maximum Output torque	6539 g.cm
DC Motor type	Brushed
Shaft Diameter	6 mm
Power Rating	7.85 W
Gearhead Type	Planetary
Length	73.9 mm
Width	32 (Dia.) mm
Current rating	990 mA
Weight	211g

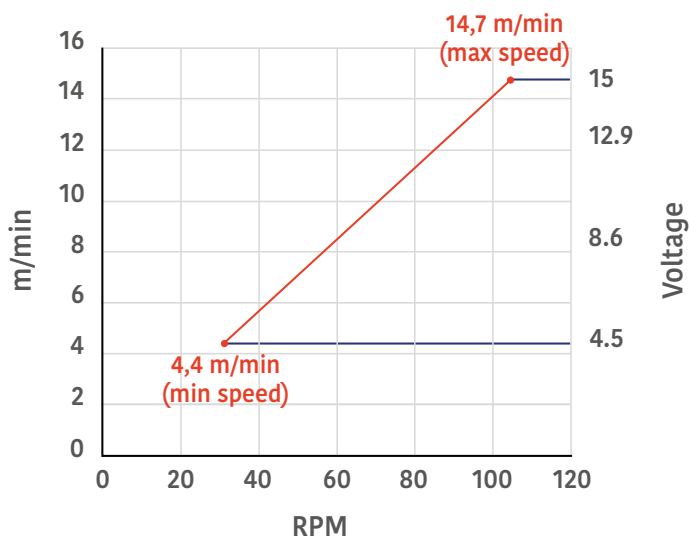

NOTE: Motor speeds may vary by (+) or (-) 12.5% RPM - Revolutions per minute m/min - Meters per minute

Zero ATP® PRO noise level

The graphic on the right shows the noise level of a 9-inch Zero ATP® PRO at different speeds with the following conditions: 1m distance, 1m height, 23°C room temperature.

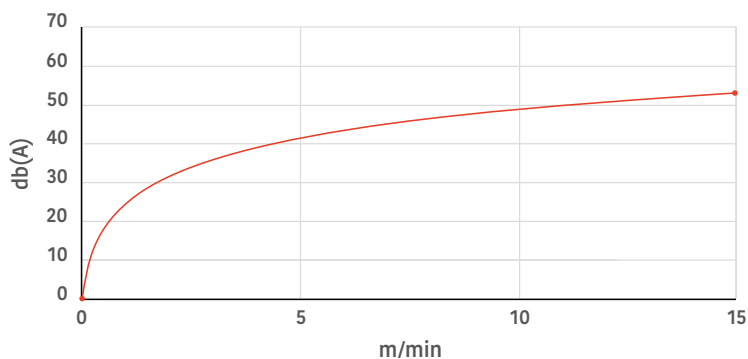

Optional cover for motor connection
Article-Nr. 300601

EXTERNAL MOTOR VERSION (POWER)

In case standard internal motor doesn't let your line achieving required speed, more powerful versions can be used. Because of the small dimension of the Zero ATP® PRO, a different motor than the standard must be fixed externally, by using a plate or directly at the conveyor frame.

The following motor is just an example of motors that can be used, able to achieve 55 m/min. Also different/traditional motor scan be used by making the required adapter.



Operating relative humidity 20% - 85%
Operating temperature range -10°C - +60°C

Technical specifications

Output Speed	309 rpm
Supply Voltage	4.5 - 15 V dc
Maximum Output torque	3000 g.cm
DC Motor type	Brushed
Shaft Diameter	6 mm
Power Rating	19.8 W
Gearhead Type	Spur
Length	82.5 mm
Width	39.3 mm
Current rating	2810 mA
Weight	285 g

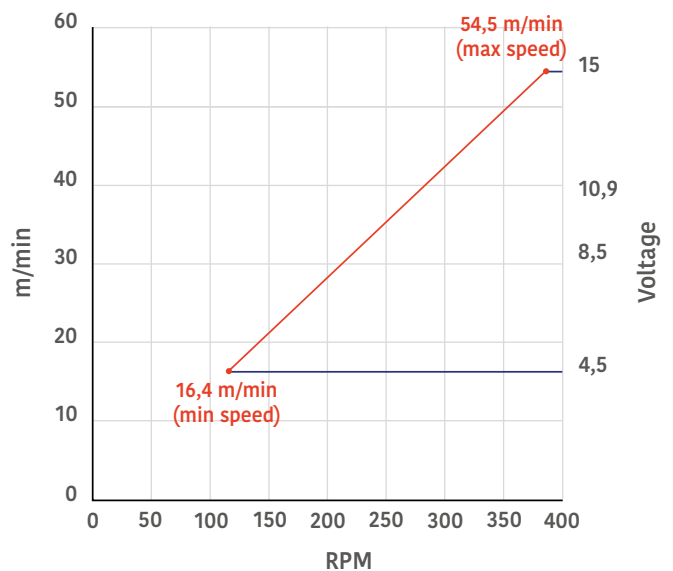

NOTE: Motor speeds may vary by (+) or (-) 12.5% RPM - Revolutions per minute m/min - Meters per minute

Zero ATP® PRO noise level

The graphic on the right shows the noise level of a 9-inch Zero ATP® PRO at different speeds with the following conditions: 1m distance, 1m height, 23°C room temperature.

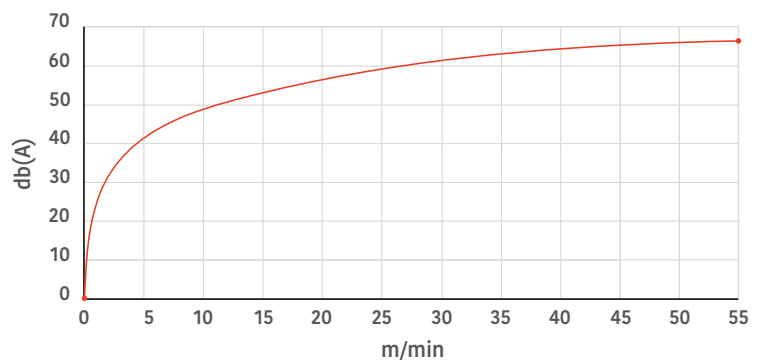

KEYED SHAFT VERSION

Zero ATP® PRO version B is provided with keyed shaft, which can be connected by using a custom motor with an adapter or with an external roller chain transmission.

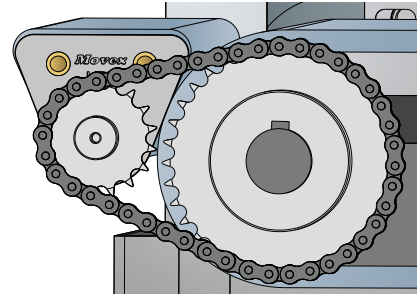

By using this graphic, you can easily calculate revolutions per minute based on the required speed. Based on the selected transmission sprockets, speed may vary more or less than established values.

RPM - Revolutions per minute
m/min - Meters per minute

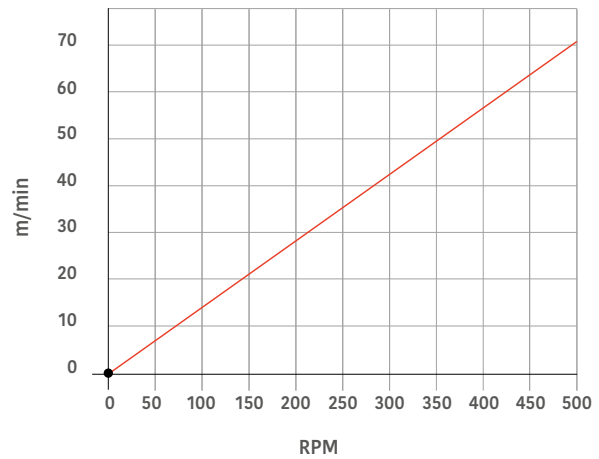

For more information about installation, please check page 42

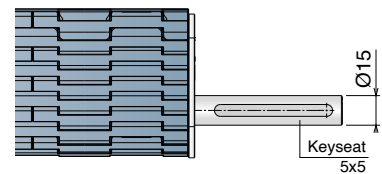
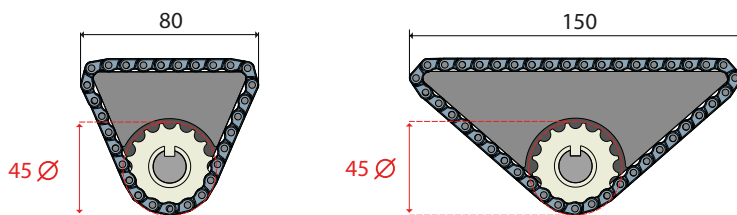

Keyed shaft version

Includes a 15 mm shaft with standard key seat 5x5 for roller chain transmission.

Output speed can be easily calculated by using the pitch diameter of the sprocket, d.45mm.

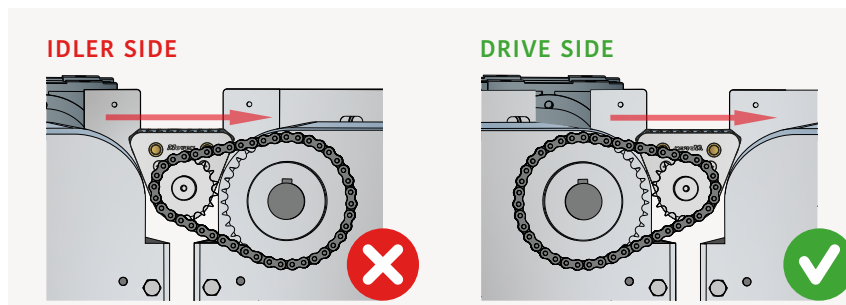

In case of a connection with roller chain transmission, it is suggested to connect the Zero ATP® PRO to the previous conveyor (drive side) for a better stability.

TRANSFER - ALIGNED

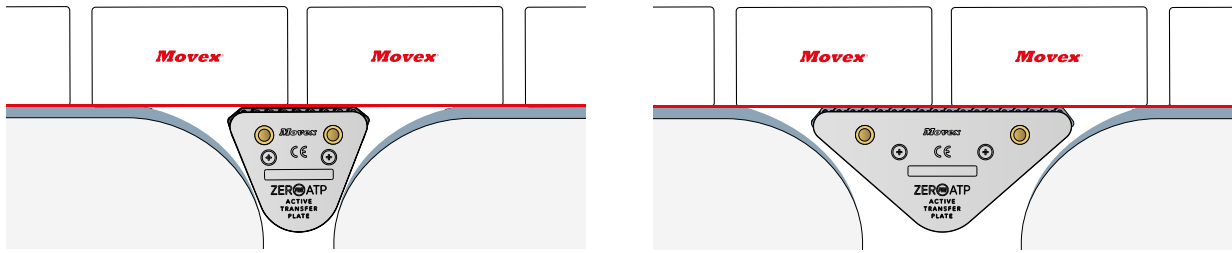

Ideal transfer for relative heavy products. The Zero ATP® PRO results in line with the infeed and outfeed belts. The product is supported from the three belts and will leave the Zero ATP® PRO in a smooth way.

TRANSFER - LOWER

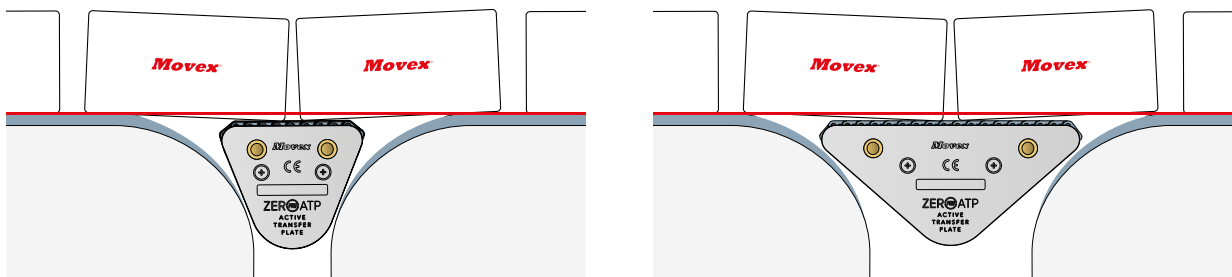

Ideal transfer for relative light products. The Zero ATP® PRO results lower than infeed and outfeed belts. The product will fall from the first belt and climb to the second belt. This transfer is ideal to give more grip to the product.

TRANSFER - UP & DOWN

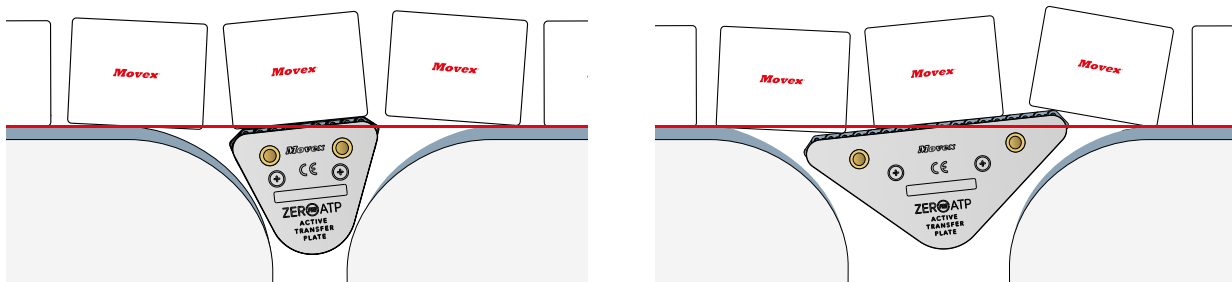

Ideal transfer when **the product results particularly small and light**. The Zero ATP® PRO results lower than the infeed belt and higher than the outfeed belt but it's installed slightly inclined. The product will fall from the first belt to the second belt while climbing on the Zero ATP® PRO. This transfer is ideal to avoid gaps on the outfeed, especially when used with Zero ATP® PRO 80.

TRANSFER - PACKFALL

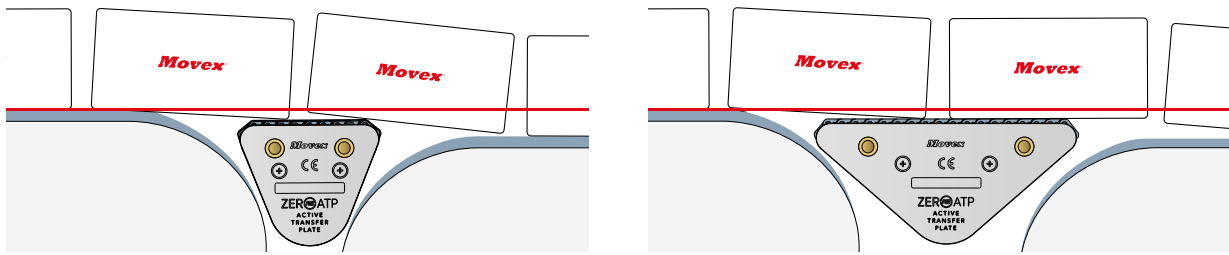

Ideal transfer when there is a mix of small and big products. The Zero ATP® PRO results lower than the infeed belt and higher than the outfeed belt and it's installed completely straight. The product will fall from the first belt to the Zero ATP® PRO and from the Zero ATP® PRO to the second belt.

TRANSFER - INCLINED/DECLINED

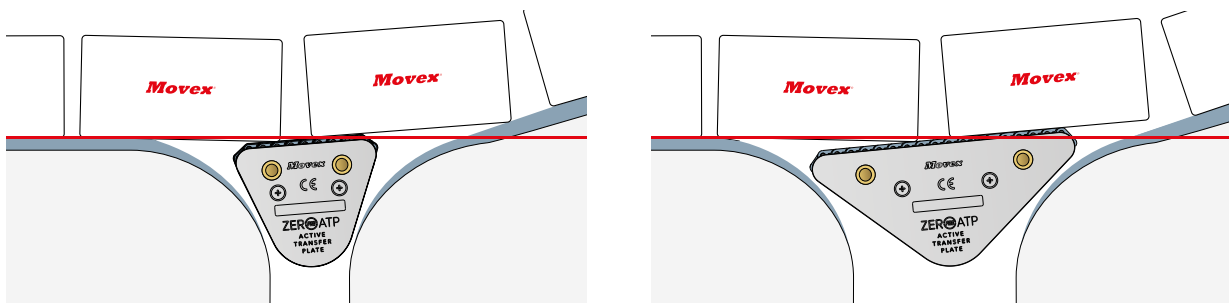

Ideal transfer to connect a straight infeed belt and an inclined outfeed belt. The Zero ATP® PRO is following the inclination of the outfeed belt. Attention: if the coefficient of friction is too low, the product may slide back, in this case it is required to reduce the inclination of the Zero ATP® PRO.

TRANSFER - HEAD TO SIDE

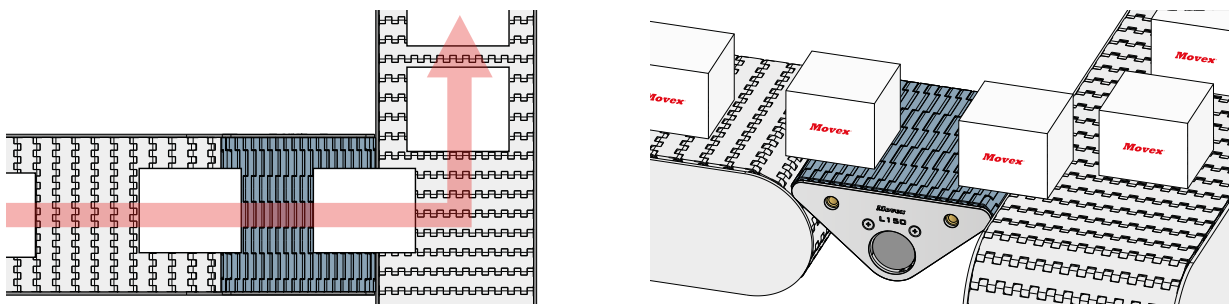

Special transfer head to side usually developed with FTI belts can be now created with Zero ATP® PRO. Products will have to be launched on the outfeed.

TABLE TRANSFER LENGTH WITH NOSEBARS / ROLLERS

MODULAR BELTS	UoM	Type of transfer		
		TRADITIONAL	ZER ^{PRO} ATP 80	ZER ^{PRO} ATP 150
510 FT	(mm)	22,0	22,0	22,0
520 FT 520 HD FT 520 FG 520 M 521 FT 522 HD FT	(mm)	40,0	27,5	26,5
525 HD FT 525 HD FG 530 FT	(mm)	40,0	29,0	28,5
520 GT	(mm)	44,0	31,5	30,5
525 HD GT	(mm)	44,0	33,0	32,5
530 GT	(mm)	44,0	33,0	32,5
530 LBP	(mm)	44,0	30,0	30,0
530 PRO LBP	(mm)	44,0	30,0	30,0
520 PRO LBP	(mm)	55,0	33,0	33,0
520 LBP	(mm)	61,0	34,0	35,0
550 FT 550 FG 550 PRO FT 550 PRO M	(mm)	63,5	36,5	36,0
550 GT	(mm)	67,5	40,5	40,0
551 FT	(mm)	71,0	39,0	39,0
551 GT	(mm)	75,0	43,0	43,0
553 FLEX TOP	(mm)	74,5	41,0	41,0
551 PRO LBP	(mm)	81,0	42,0	41,0
556 FT	(mm)	82,0	43,0	42,0
556 GT	(mm)	86,0	47,0	46,0
600 FT	(mm)	90,5	46,0	44,0
551 LBP	(mm)	94,0	46,0	43,0

LT= Transfer length between NoseBars.

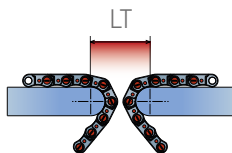

LT= Transfer length between Zero ATP® PRO 80 and NoseBars.

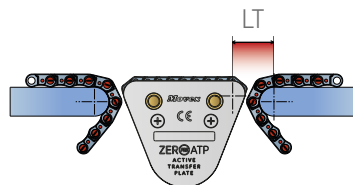

LT= Transfer length between Zero ATP® PRO 150 and NoseBars.

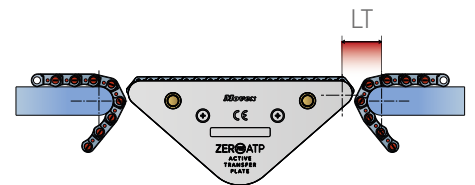

Zero ATP® PRO | 520 FT - with NoseBars Ø19

Valid also for: 520 HD FT; 520 FTT; 520 FG; 520 M; 521 FT, 522 HD FT.

520 FT - 520 FT

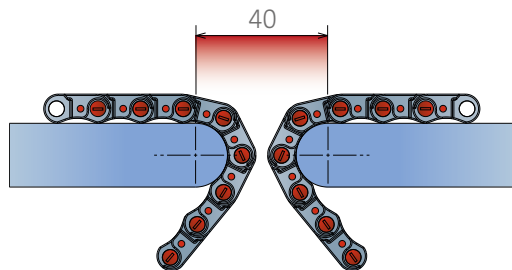

LT
40,0 mm

520 FT - ZER^{PRO}ATP 80 - 520 FT

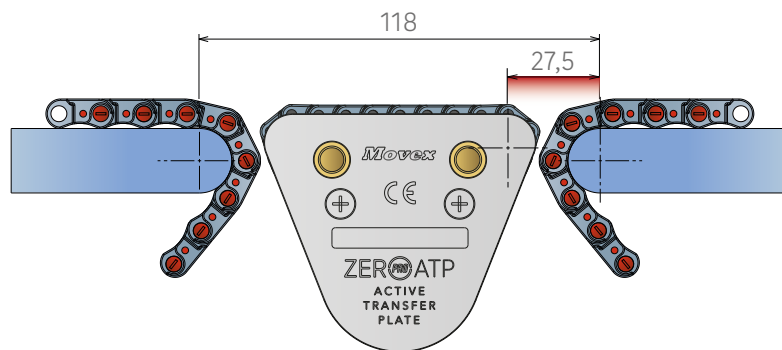

LT	Δ%:
27,5 mm	- 31%

520 FT - ZER^{PRO}ATP 150 - 520 FT

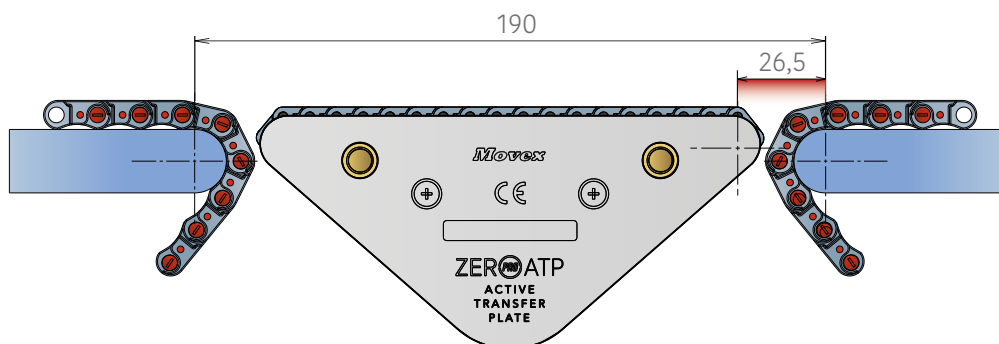

LT	Δ%:
26,5 mm	- 34%

LT: Transfer length center to center (see page 12)

Δ%: Refers to the comparison between transfer with NoseBars and transfer with Zero ATP® PRO.

520 LBP - 520 LBP

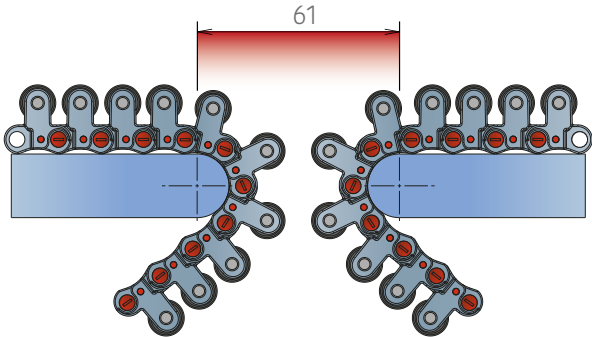

LT
61,0 mm

520 LBP - ZER^{PRO}ATP 80 - 520 LBP

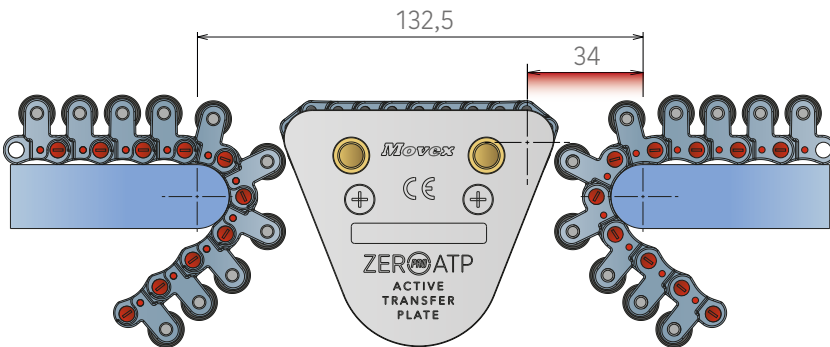

LT	Δ%:
34,0 mm	- 44%

520 LBP - ZER^{PRO}ATP 150 - 520 LBP

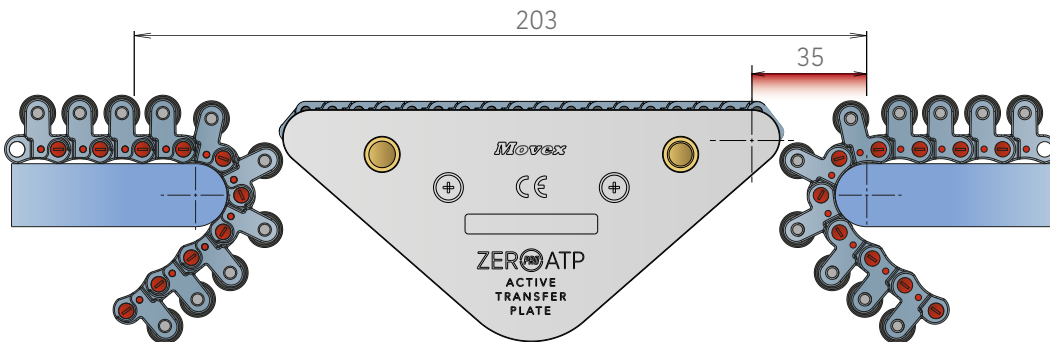

LT	Δ%:
35,0 mm	- 43%

LT: Transfer length center to center (see page 12)

Δ%: Refers to the comparison between transfer with NoseBars and transfer with Zero ATP® PRO.

520 PRO LBP - 520 PRO LBP

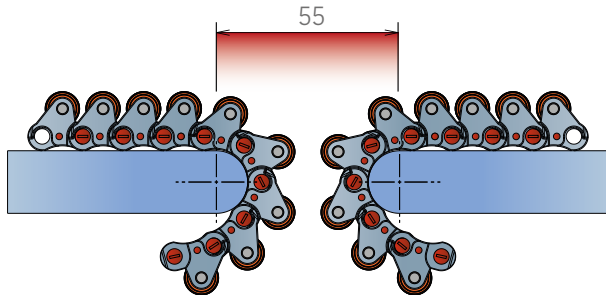

LT
55,0 mm

520 PRO LBP - ZEROPRO ATP 80 - 520 PRO LBP

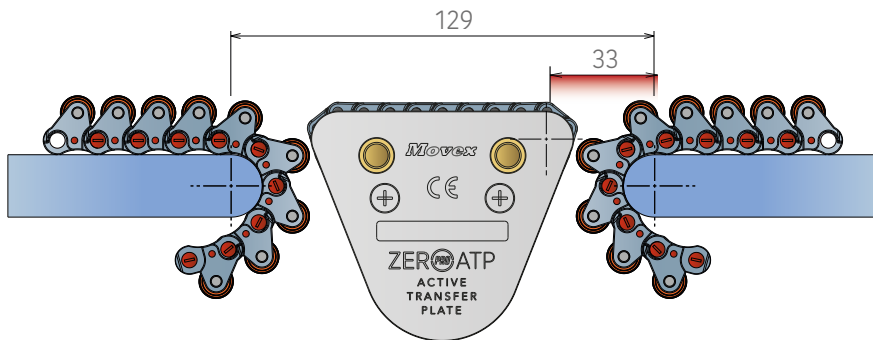

LT	Δ%:
33,0 mm	- 40%

520 PRO LBP - ZEROPRO ATP 150 - 520 PRO LBP

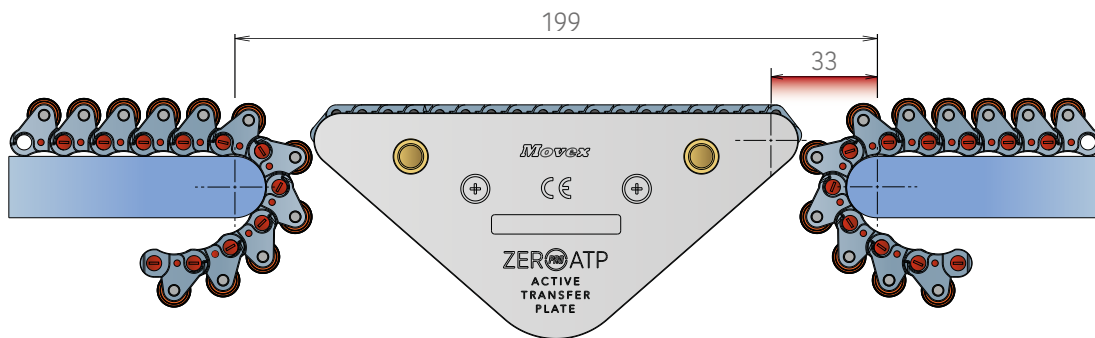

LT	Δ%:
33,0 mm	- 40%

LT: Transfer length center to center (see page 12)

Δ%: Refers to the comparison between transfer with NoseBars and transfer with Zero ATP® PRO.

Valid also for: 525 FTT; 525 FG; 530 FT; 530 FTT.

525 FT - 525 FT

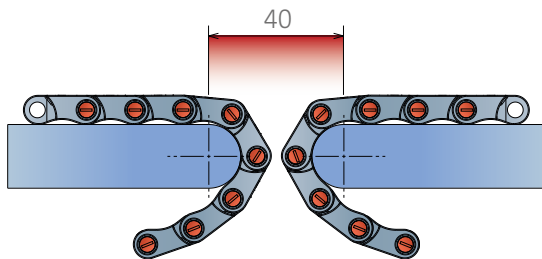

LT
40,0 mm

525 FT - ZER^{PRO}ATP80 - 525 FT

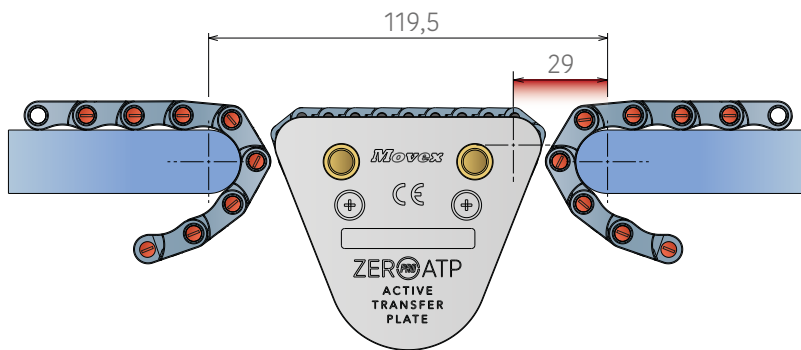

LT	Δ%:
29,0 mm	- 28%

525 FT - ZER^{PRO}ATP150 - 525 FT

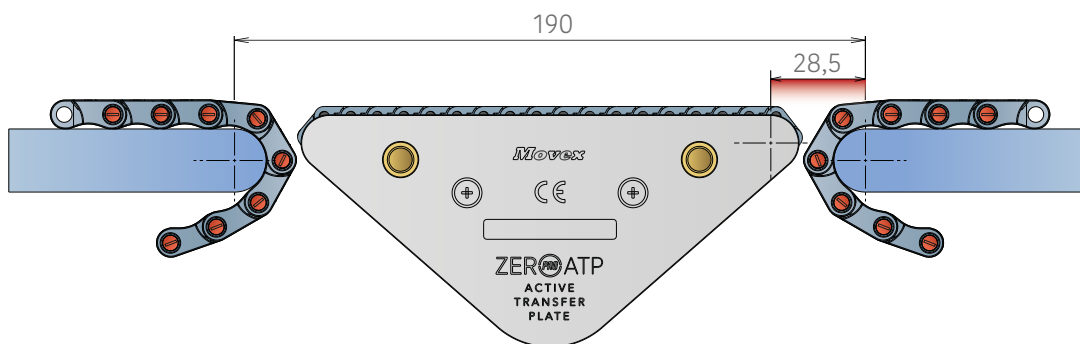

LT	Δ%:
28,5 mm	- 29%

LT: Transfer length center to center (see page 12)

Δ%: Refers to the comparison between transfer with NoseBars and transfer with Zero ATP® PRO.

Valid also for: 530 LBP.

530 PRO LBP - 530 PRO LBP

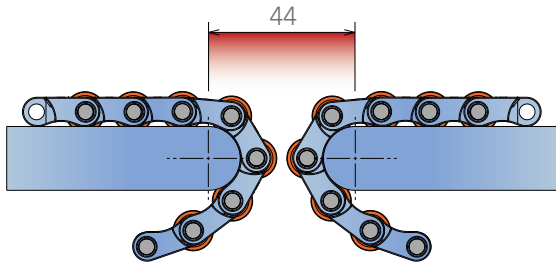

LT
44,0 mm

530 PRO LBP - ZEROATP 80 - 530 PRO LBP

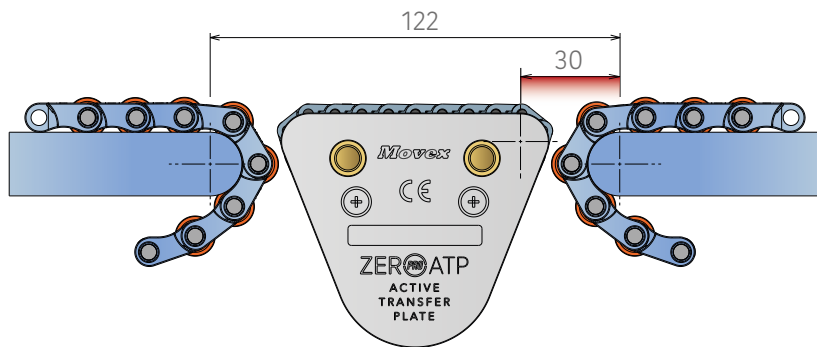

LT	Δ%:
30,0 mm	- 32%

530 PRO LBP - ZEROATP 150 - 530 PRO LBP

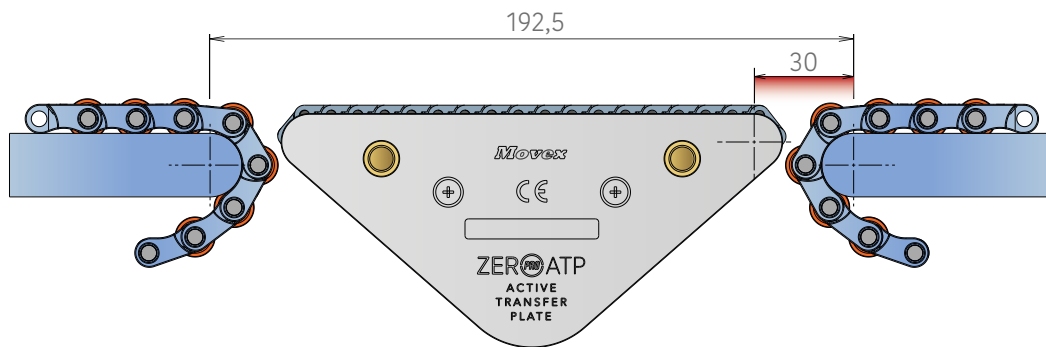

LT	Δ%:
30,0 mm	- 32%

LT: Transfer length center to center (see page 12)

Δ%: Refers to the comparison between transfer with NoseBars and transfer with Zero ATP® PRO.

Valid also for: 550 FTT; 550 FG; 550 PRO FT; 550 PRO M.

550 FT - 550 FT

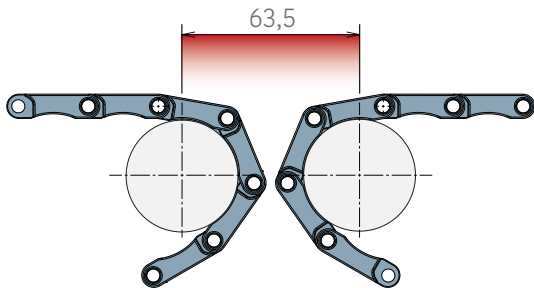

LT
63,5 mm

550 FT - ZERO^{PRO}ATP80 - 550 FT

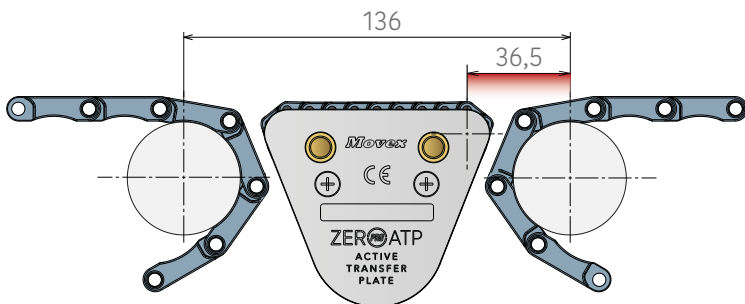

LT	Δ%:
36,5 mm	- 42%

550 FT - ZERO^{PRO}ATP150 - 550 FT

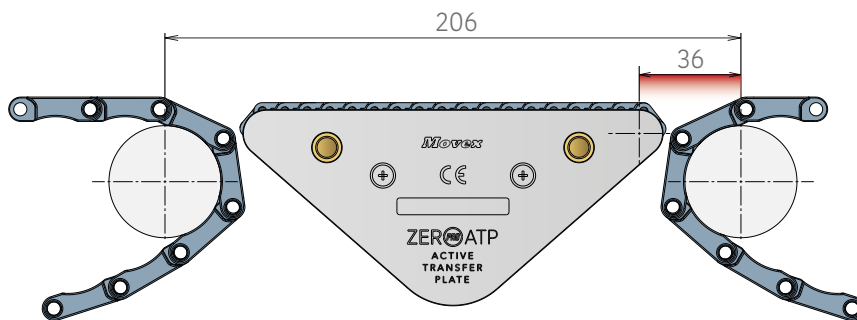

LT	Δ%:
36,0 mm	- 43%

LT: Transfer length center to center (see page 12)

Δ%: Refers to the comparison between transfer with NoseBars and transfer with Zero ATP® PRO.

Valid also for: 551 FTT.

551 FT - 551 FT

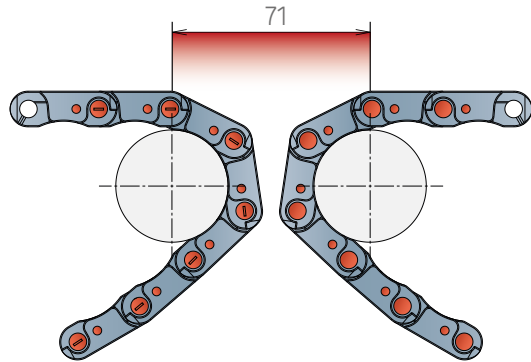

LT
71,0 mm

551 FT - ZERO^{PRO}ATP80 - 551 FT

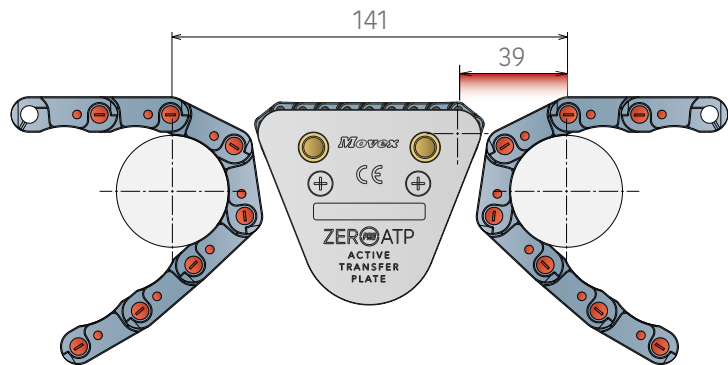

LT	Δ%:
39,0 mm	- 45%

551 FT - ZERO^{PRO}ATP150 - 551 FT

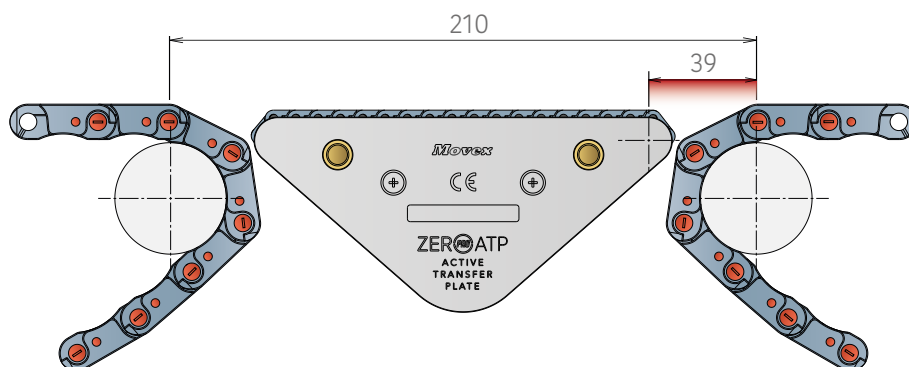

LT	Δ%:
39,0 mm	- 45%

LT: Transfer length center to center (see page 12)

Δ%: Refers to the comparison between transfer with NoseBars and transfer with Zero ATP® PRO.

551 LBP - 551 LBP

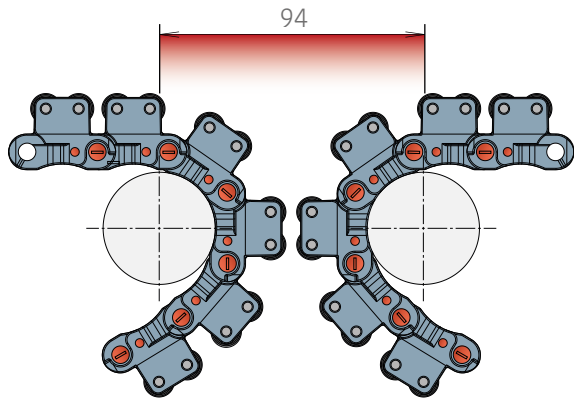

LT
94,0 mm

551 LBP - ZERO ATP 80 - 551 LBP

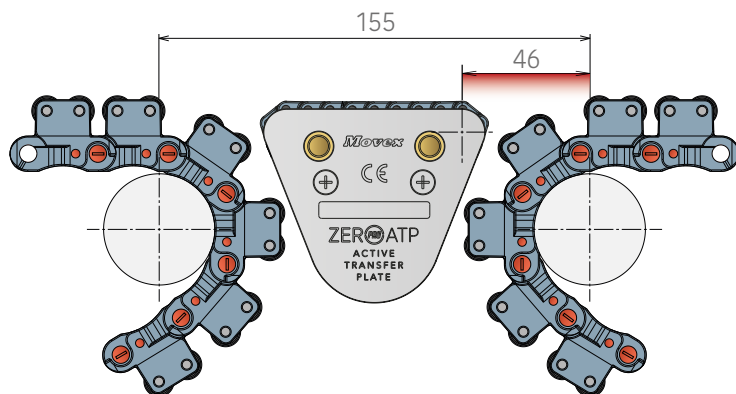

LT	Δ%:
46,0 mm	- 51%

551 LBP PRO ATP150 - 551 LBP

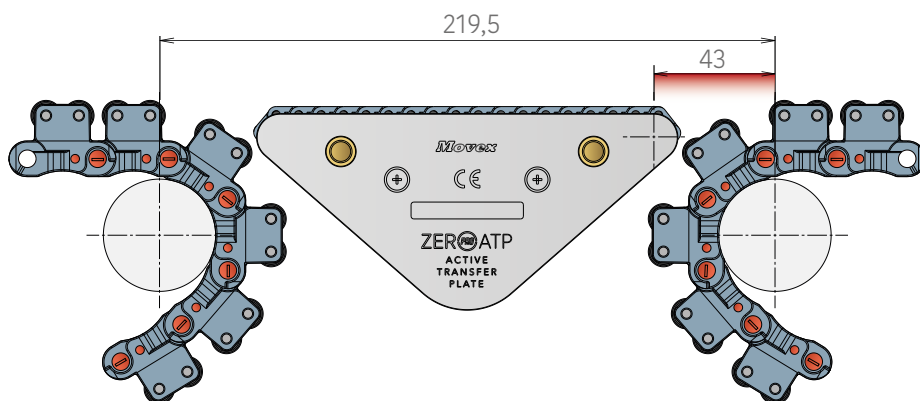

LT	Δ%:
43,0 mm	- 54%

LT: Transfer length center to center (see page 12)

Δ%: Refers to the comparison between transfer with NoseBars and transfer with Zero ATP® PRO.

551 PRO LBP - 551 PRO LBP

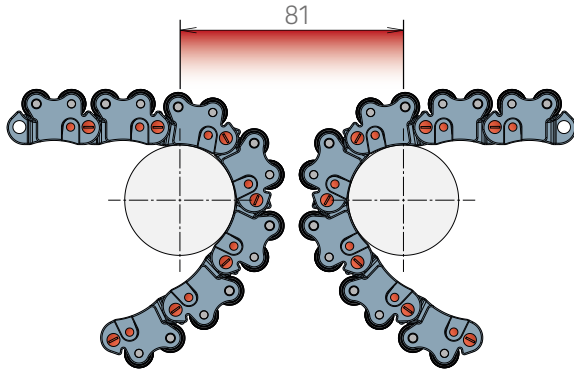

LT
81,0 mm

551 PRO LBP - ZERO ATP 80 - 551 PRO LBP

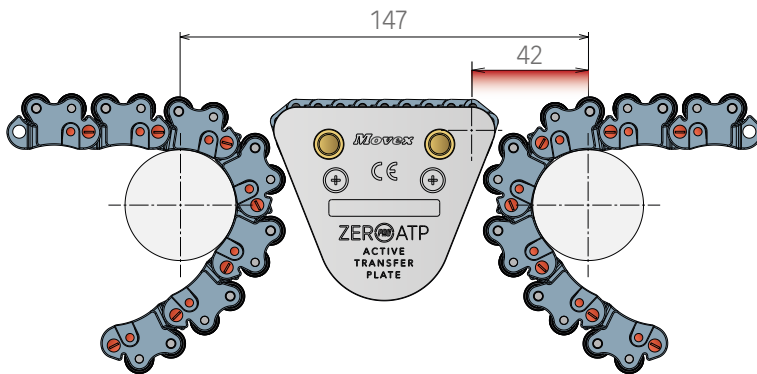

LT	Δ%:
42,0 mm	- 48%

551 PRO LBP - ZERO ATP 150 - 551 PRO LBP

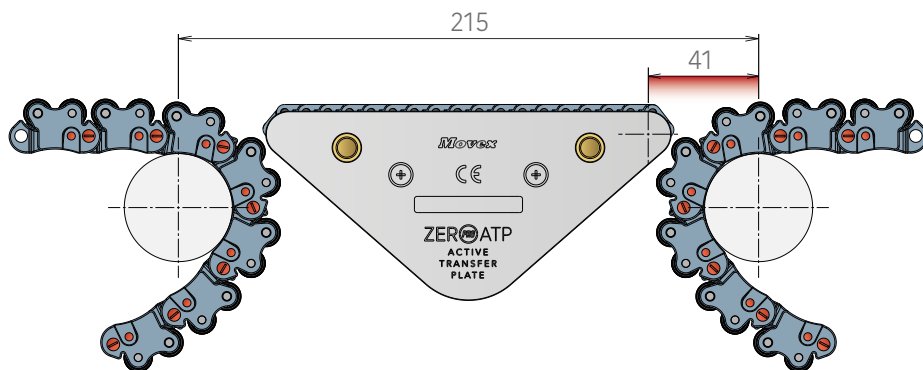

LT	Δ%:
41,0 mm	- 49%

LT: Transfer length center to center (see page 12)

Δ%: Refers to the comparison between transfer with NoseBars and transfer with Zero ATP® PRO.

533 FLEXTOP - 533 FLEXTOP

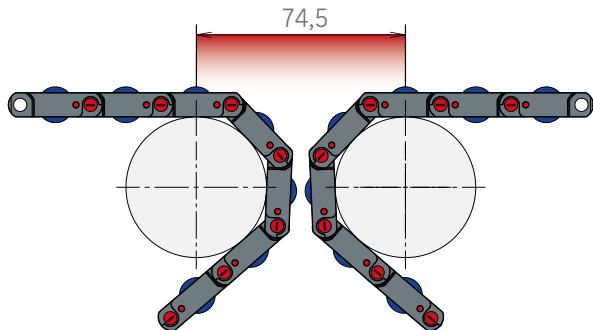

LT
74,5 mm

533 FLEXTOP - ZEROATP80 - 533 FLEXTOP

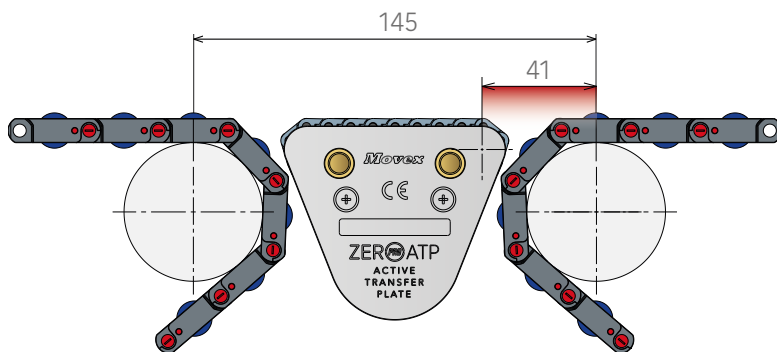

LT	Δ%:
41,0 mm	- 45%

533 FLEXTOP - ZEROATP150 - 533 FLEXTOP

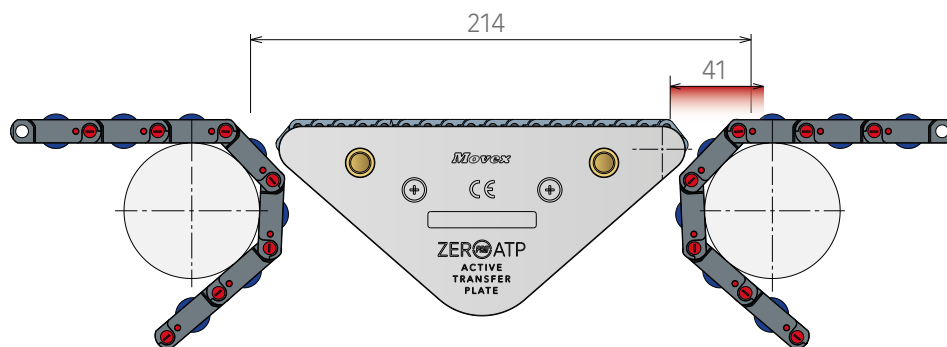

LT	Δ%:
41,0 mm	- 45%

LT: Transfer length center to center (see page 12)

Δ%: Refers to the comparison between transfer with NoseBars and transfer with Zero ATP® PRO.

556 FT - 556 FT

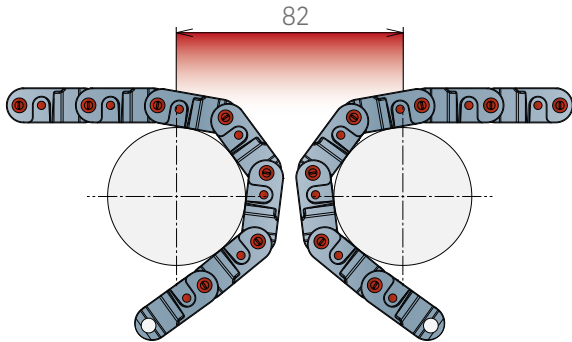

LT
82,0 mm

556 FT - ZEROPRO ATP 80 - 556 FT

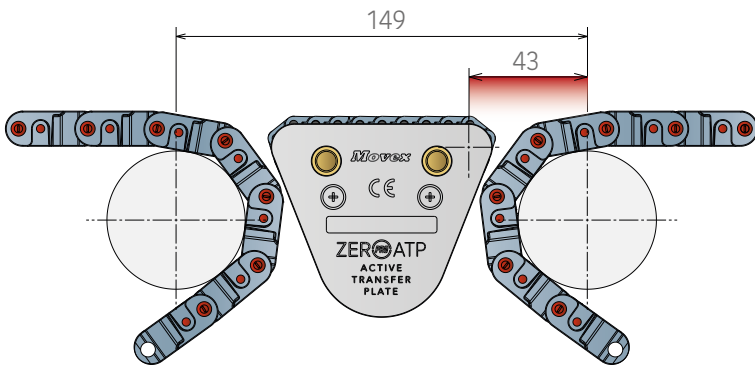

LT	Δ%:
43,0 mm	- 47%

556 FT - ZEROPRO ATP 150 - 556 FT

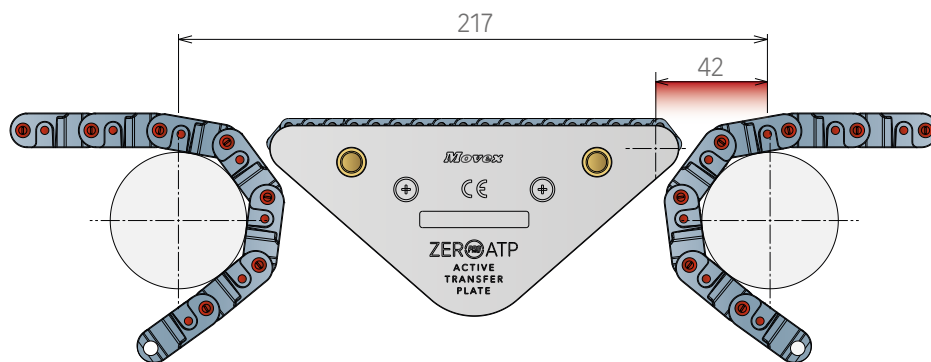

LT	Δ%:
42,0 mm	- 48%

LT: Transfer length center to center (see page 12)

Δ%: Refers to the comparison between transfer with NoseBars and transfer with Zero ATP® PRO.

600 FT - 600 FT

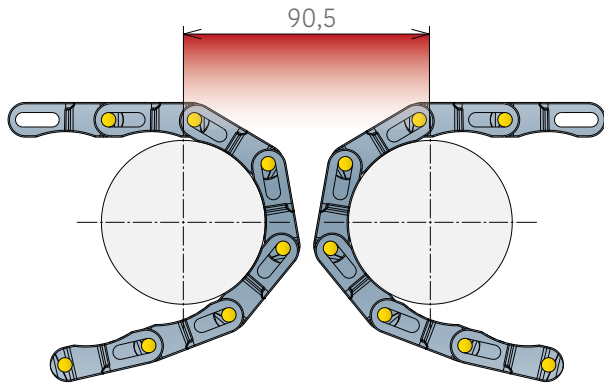

LT
90,5 mm

600 FT - ZERO^{PRO}ATP 80 - 600 FT

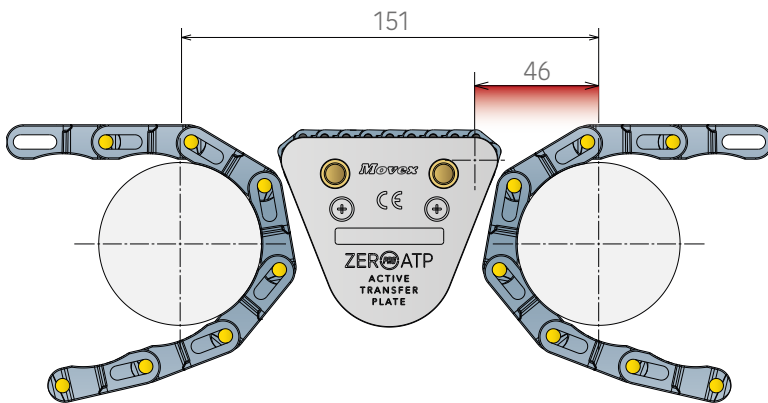

LT	Δ%:
46,0 mm	- 49%

600 FT - ZERO^{PRO}ATP 150 - 600 FT

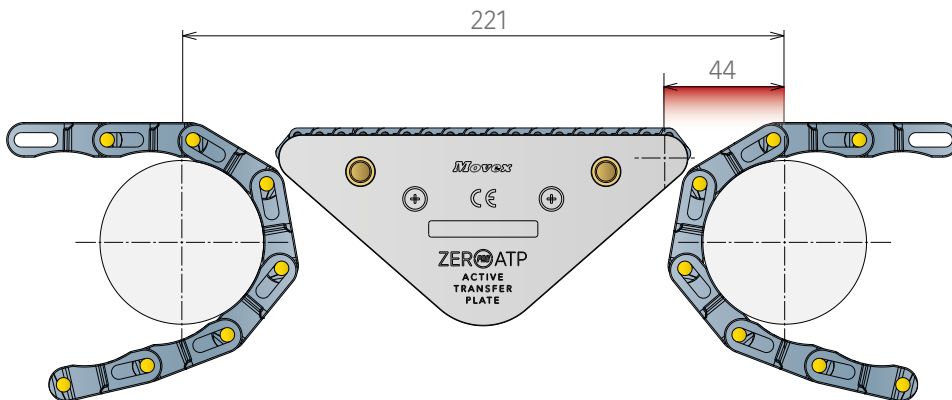

LT	Δ%:
44,0 mm	- 51%

LT: Transfer length center to center (see page 12)

Δ%: Refers to the comparison between transfer with NoseBars and transfer with Zero ATP® PRO.

TABLE TRANSFER LENGTH WITH SPROCKETS

BELT	TRANSFER	UoM	Z - n° of teeth												
			z-10	z-12	z-13	z-14	z-15	z-16	z-18	z-20	z-24	z-28	z-32	z-36	z-40
520 FT 520 HD FT 520 FG 520 M 521 FT 522 HD FT	TRADITIONAL	(mm)	-	-	-	-	-	-	-	-	178,0	181,0	-	191,5	195,0
	ZER ^{PRO} ATP 80	(mm)	-	-	-	-	-	-	-	-	52,0	57,5	-	68,5	74,0
	ZER ^{PRO} ATP 150	(mm)	-	-	-	-	-	-	-	-	49,0	52,0	-	59,0	62,0
520 LBP	TRADITIONAL	(mm)	-	-	-	-	-	-	-	-	183,6	188,0	-	200,5	204,0
	ZER ^{PRO} ATP 80	(mm)	-	-	-	-	-	-	-	-	60,0	65,0	-	76,0	82,0
	ZER ^{PRO} ATP 150	(mm)	-	-	-	-	-	-	-	-	53,5	57,0	-	63,0	66,0
520 PRO LBP	TRADITIONAL	(mm)	-	-	-	-	-	-	-	-	181,0	186,5	-	193,0	203,0
	ZER ^{PRO} ATP 80	(mm)	-	-	-	-	-	-	-	-	58,0	63,5	-	74,5	80,0
	ZER ^{PRO} ATP 150	(mm)	-	-	-	-	-	-	-	-	52,0	56,0	-	62,0	65,0
525 FT 525 FTT 525 FG 530 FT 530 FTT	TRADITIONAL	(mm)	-	93,0	-	-	-	-	171,0	-	-	180,0	-	193,0	-
	ZER ^{PRO} ATP 80	(mm)	-	37,0	-	-	-	-	44,0	-	-	57,0	-	70,0	-
	ZER ^{PRO} ATP 150	(mm)	-	37,0	-	-	-	-	42,0	-	-	52,0	-	60,0	-
530 LBP 530 PRO LBP	TRADITIONAL	(mm)	-	96,0	-	-	-	-	130,0	-	-	185,0	-	198,0	-
	ZER ^{PRO} ATP 80	(mm)	-	38,5	-	-	-	-	45,0	-	-	58,0	-	71,0	-
	ZER ^{PRO} ATP 150	(mm)	-	38,0	-	-	-	-	43,0	-	-	52,0	-	60,0	-
550 FT 550 FTT 550 FG 550 PRO FT 550 PRO M	TRADITIONAL	(mm)	-	-	-	187,0	-	185,0	196,0	199,0	-	-	-	-	-
	ZER ^{PRO} ATP 80	(mm)	-	-	-	58,0	-	63,0	69,0	74,0	-	-	-	-	-
	ZER ^{PRO} ATP 150	(mm)	-	-	-	54,0	-	56,0	60,0	62,0	-	-	-	-	-
553 FLEXTOP	TRADITIONAL	(mm)	-	136,5	-	-	191,5	-	198,0	-	-	-	-	-	-
	ZER ^{PRO} ATP 80	(mm)	-	53,0	-	-	62,0	-	69,5	-	-	-	-	-	-
	ZER ^{PRO} ATP 150	(mm)	-	49,5	-	-	55,0	-	60,0	-	-	-	-	-	-
556 FT	TRADITIONAL	(mm)	131,5	142,0	-	-	189,0	-	197,0	-	-	-	-	-	-
	ZER ^{PRO} ATP 80	(mm)	48,0	55,0	-	-	62,0	-	70,0	-	-	-	-	-	-
	ZER ^{PRO} ATP 150	(mm)	46,0	52,0	-	-	55,0	-	60,0	-	-	-	-	-	-
600 FT	TRADITIONAL	(mm)	140,0	-	191,0	-	197,0	204,0	-	-	-	-	-	-	-
	ZER ^{PRO} ATP 80	(mm)	54,0	-	64,0	-	71,0	75,0	-	-	-	-	-	-	-
	ZER ^{PRO} ATP 150	(mm)	51,0	-	56,5	-	60,0	63,0	-	-	-	-	-	-	-

Continue >>

TABLE TRANSFER LENGTH WITH SPROCKETS

BELT	TRANSFER	UoM	Z - n° of teeth											
			z-11	z-14	z-16	z-17	z-18	z-19	z-20	z-21	z-23	z-25	z-27	z-29
551 FT 551 FTT	TRADITIONAL	(mm)	135,0	190,0	190,0	-	198,0	-	202,0	204,0	-	-	-	-
	ZER ^{PRO} ATP 80	(mm)	51,0	58,0	63,0	-	69,0	-	74,0	77,0	-	-	-	-
	ZER ^{PRO} ATP 150	(mm)	49,0	54,0	56,0	-	60,0	-	62,0	64,0	-	-	-	-
551 LBP	TRADITIONAL	(mm)	138,0	194,0	195,0	-	206,0	-	206,0	208,0	-	-	-	-
	ZER ^{PRO} ATP 80	(mm)	59,0	67,0	72,0	-	78,0	-	83,0	85,5	-	-	-	-
	ZER ^{PRO} ATP 150	(mm)	53,0	58,0	60,0	-	64,0	-	66,0	68,0	-	-	-	-
551 PRO LBP	TRADITIONAL	(mm)	137,0	190,0	192,0	-	200,0	-	202,0	204,0	-	-	-	-
	ZER ^{PRO} ATP 80	(mm)	54,0	62,0	67,0	-	73,0	-	78,0	81,0	-	-	-	-
	ZER ^{PRO} ATP 150	(mm)	50,0	55,0	57,0	-	62,0	-	64,0	65,0	-	-	-	-
820 FT	TRADITIONAL	(mm)	-	-	-	136,5	-	190,0	-	193,5	197,0	200,0	202,0	204,0
	ZER ^{PRO} ATP 80	(mm)	-	-	-	57,0	-	61,0	-	65,0	69,0	73,0	77,0	81,0
	ZER ^{PRO} ATP 150	(mm)	-	-	-	52,0	-	55,0	-	58,0	60,0	62,0	64,0	66,5
821 LBP	TRADITIONAL	(mm)	-	-	-	181,5	-	196,0	-	200,0	204,0	207,0	209,0	224,0
	ZER ^{PRO} ATP 80	(mm)	-	-	-	65,0	-	69,0	-	74,0	78,0	83,0	86,0	90,0
	ZER ^{PRO} ATP 150	(mm)	-	-	-	56,0	-	58,0	-	61,0	63,0	66,0	68,0	70,0

LT= Transfer length between sprockets.

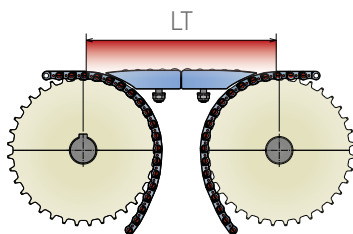

LT= Transfer length between Zero ATP® PRO 80 and sprockets.

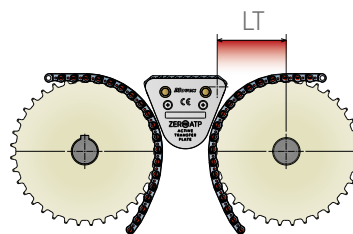

LT= Transfer length between Zero ATP® PRO 150 and sprockets.

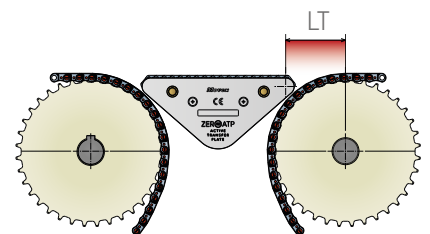

Valid also for: 520 HD FT; 520 FTT; 520 FG; 520 M; 521 FT; 522 HD FT

520 FT - 520 FT

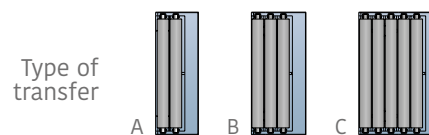
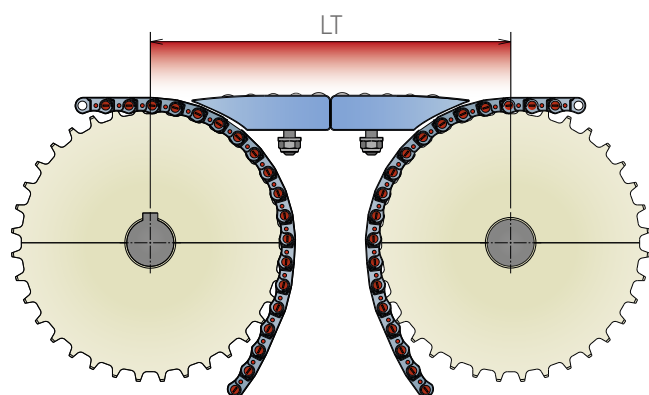

Z (n°of teeth)	LT	Type*
z-24	178,0 mm	C
z-28	181,0 mm	C
z-36	191,5 mm	C
z-40	195,0 mm	C

520 FT - ZEROATP 80 - 520 FT

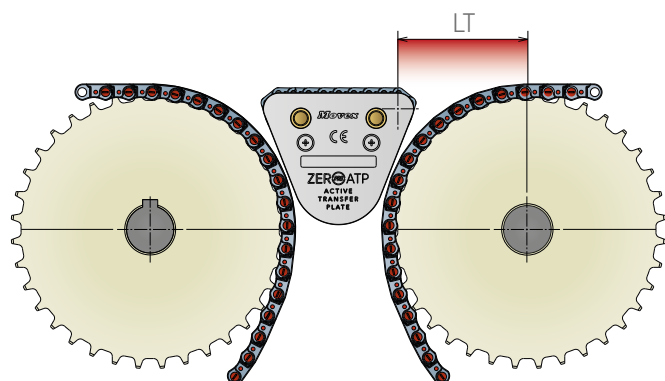

Z (n°of teeth)	LT	Δ%:
z-24	52,0 mm	- 71%
z-28	57,5 mm	- 68%
z-36	68,5 mm	- 64%
z-40	74,0 mm	- 62%

520 FT - ZEROATP 150 - 520 FT

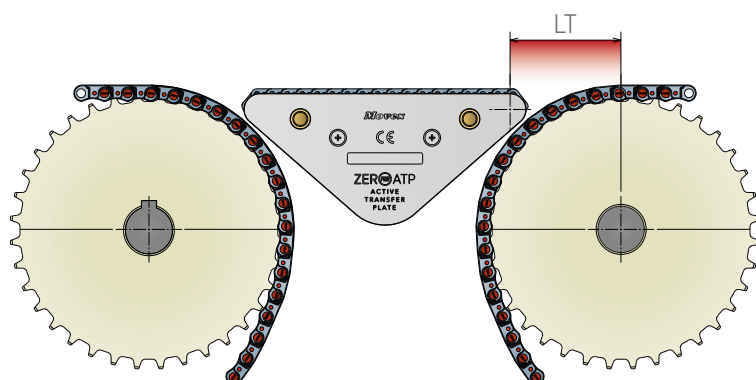

Z (n°of teeth)	LT	Δ%:
z-24	49,0 mm	- 72%
z-28	52,0 mm	- 71%
z-36	59,0 mm	- 69%
z-40	62,0 mm	- 68%

LT: Transfer length center to center (see page 26)

Δ%: Refers to a comparison between transfer with sprockets and transfer with Zero ATP® PRO.

*Transfer A, B, C can also be combined together to get different/shorter distances.

520 LBP - 520 LBP

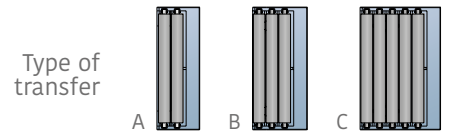
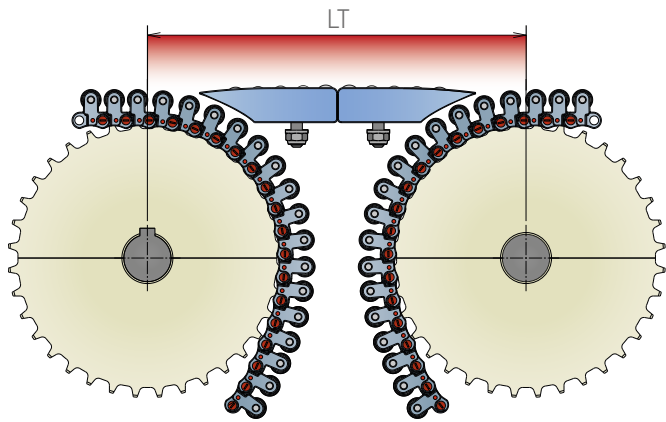

Z (n°of teeth)	LT	Type*
z-24	183,6 mm	C
z-28	188,0 mm	C
z-36	200,5 mm	C
z-40	204,0 mm	C

520 LBP - ZEROPRO ATP 80 - 520 LBP

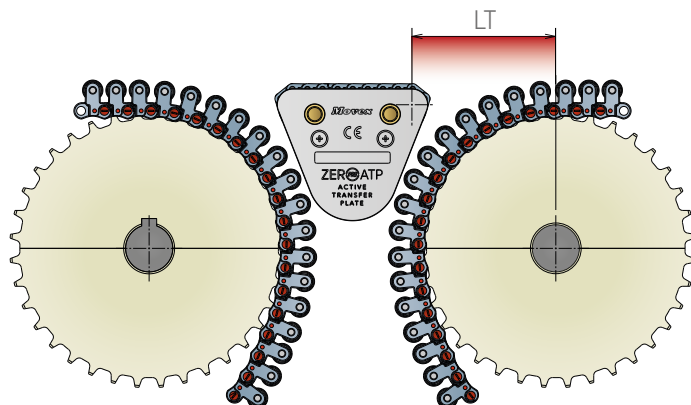

Z (n°of teeth)	LT	Δ%:
z-24	60,0 mm	- 63%
z-28	65,0 mm	- 65%
z-36	76,0 mm	- 62%
z-40	82,0 mm	- 59%

520 LBP - ZEROPRO ATP150 - 520 LBP

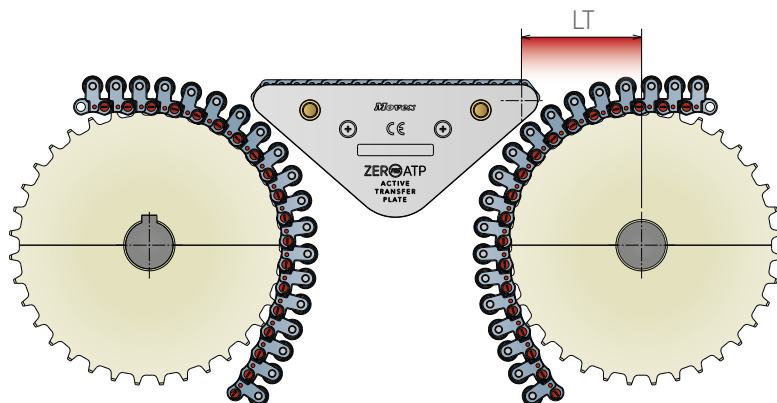

Z (n°of teeth)	LT	Δ%:
z-24	53,5 mm	- 71%
z-28	57,0mm	- 69%
z-36	63,0 mm	- 68%
z-40	66,0 mm	- 67%

LT: Transfer length center to center (see page 26)

Δ%: Refers to a comparison between transfer with sprockets and transfer with Zero ATP® PRO.

*Transfer A, B, C can also be combined together to get different/shorter distances.

520 PRO LBP - 520 PRO LBP

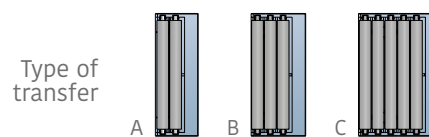
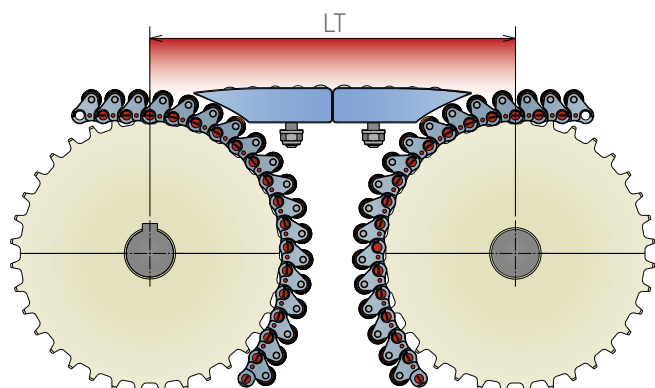

Z (n°of teeth)	LT	Type*
z-24	181,0 mm	C
z-28	186,5 mm	C
z-36	193,0 mm	C
z-40	203,0 mm	C

520 PRO LBP - ZEROPRO ATP 80 - 520 PRO LBP

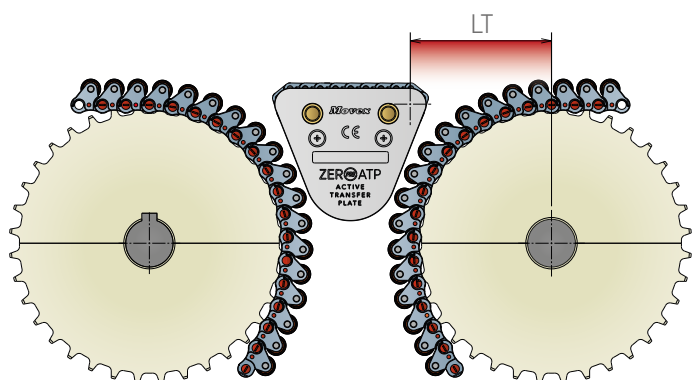

Z (n°of teeth)	LT	Δ%:
z-24	58,0 mm	- 68%
z-28	63,5 mm	- 66%
z-36	74,5 mm	- 61%
z-40	80,0 mm	- 60%

520 PRO LBP - ZEROPRO ATP 150 - 520 PRO LBP

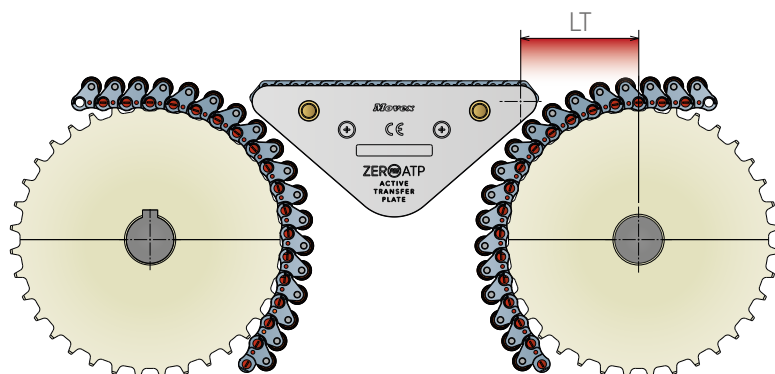

Z (n°of teeth)	LT	Δ%:
z-24	52,0 mm	- 71%
z-28	56,0 mm	- 70%
z-36	62,0 mm	- 67%
z-40	65,0 mm	- 68%

LT: Transfer length center to center (see page 26)

Δ%: Refers to a comparison between transfer with sprockets and transfer with Zero ATP® PRO.

*Transfer A, B, C can also be combined together to get different/shorter distances.

Valid also for: 525 FTT; 525 FG; 530 FT; 530 FTT

525 FT - 525 FT

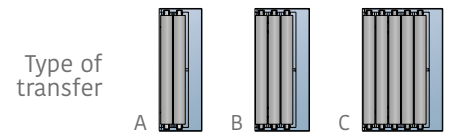
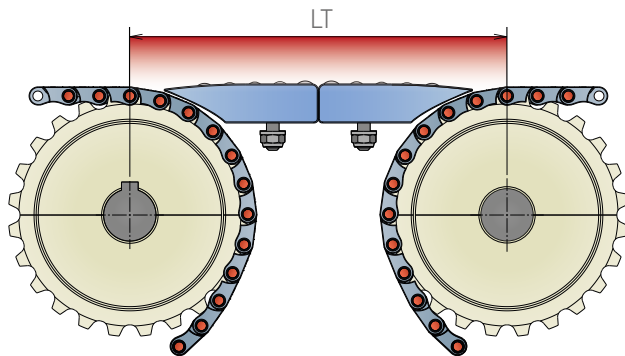

Z (n°of teeth)	LT	Type*
z-12	93,0 mm	A
z-16	171,0 mm	C
z-24	180,0 mm	C
z-32	193,0 mm	C

525 FT - ZEROATP80 - 525 FT

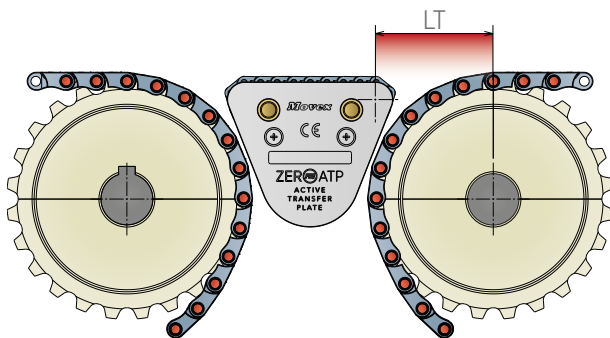

Z (n°of teeth)	LT	Δ%:
z-12	37,0 mm	- 60%
z-16	44,0 mm	- 74%
z-24	57,0 mm	- 68%
z-32	70,0 mm	- 63%

525 FT - ZEROATP150 - 525 FT

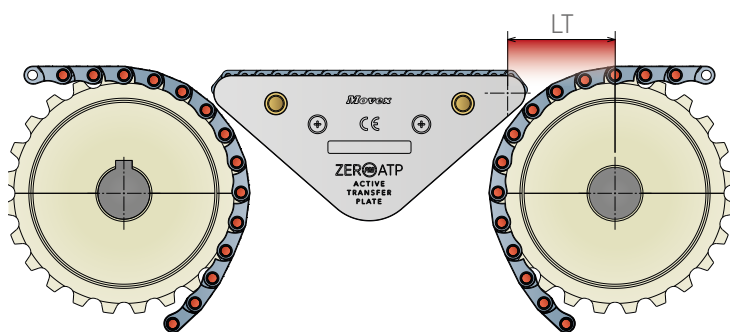

Z (n°of teeth)	LT	Δ%:
z-12	37,0 mm	- 60%
z-16	42,0 mm	- 71%
z-24	52,0 mm	- 71%
z-32	60,0 mm	- 68%

LT: Transfer length center to center (see page 26)

Δ%: Refers to a comparison between transfer with sprockets and transfer with Zero ATP® PRO.

*Transfer A, B, C can also be combined together to get different/shorter distances.

Valid also for: 530 LBP

530 PRO LBP - 530 PRO LBP

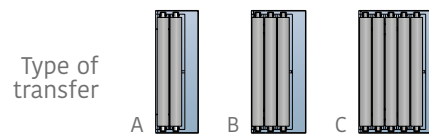
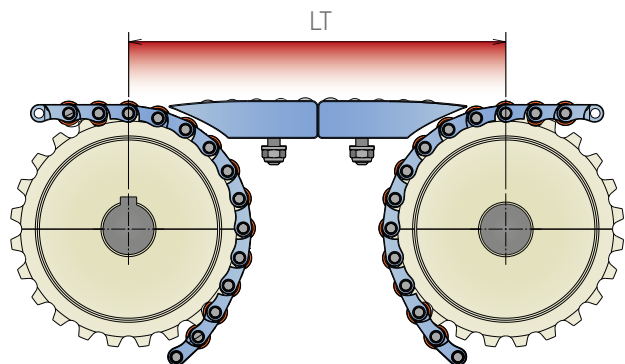

Z (n°of teeth)	LT	Type*
z-12	96,0 mm	A
z-16	130,0 mm	B
z-24	185,0 mm	C
z-32	198,0 mm	C

530 PRO LBP - ZEROATP80 - 530 PRO LBP

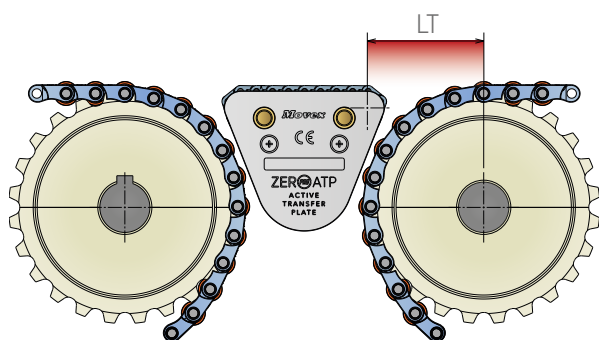

Z (n°of teeth)	LT	Δ%:
z-12	38,5 mm	- 60%
z-16	45,0 mm	- 65%
z-24	58,0 mm	- 68%
z-32	71,0 mm	- 64%

530 PRO LBP - ZEROATP150 - 530 PRO LBP

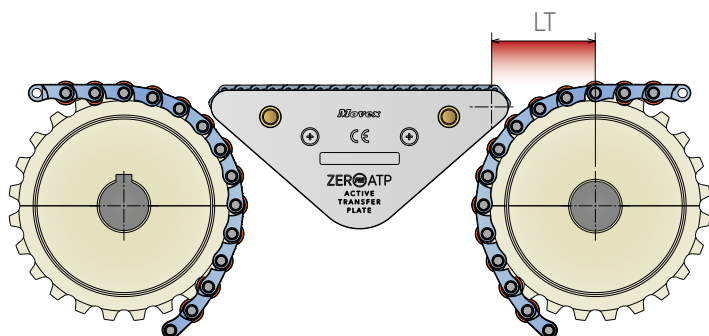

Z (n°of teeth)	LT	Δ%:
z-12	38,0 mm	- 60%
z-16	43,0 mm	- 66%
z-24	52,0 mm	- 71%
z-32	60,0 mm	- 69%

LT: Transfer length center to center (see page 26)

Δ%: Refers to a comparison between transfer with sprockets and transfer with Zero ATP® PRO.

*Transfer A, B, C can also be combined together to get different/shorter distances.

Valid also for: 550 FTT, 550 FG, 550 PRO FT, 550 PRO M

550 FT - 550 FT

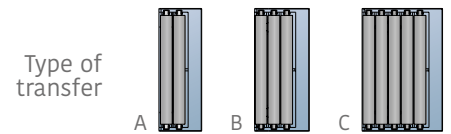
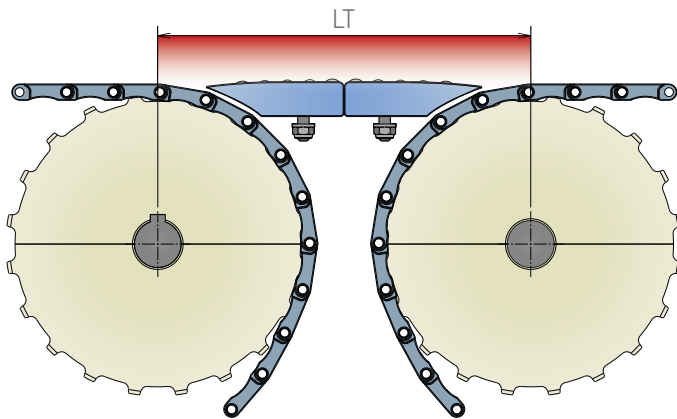

Z (n°of teeth)	LT	Type*
z-14	187,0 mm	C
z-16	185,0 mm	C
z-18	196,0 mm	C
z-20	199,0 mm	C

550 FT - ZEROATP80 - 550 FT

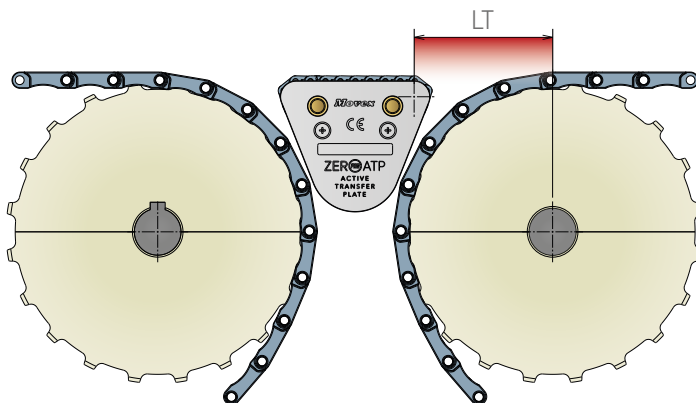

Z (n°of teeth)	LT	Δ%:
z-14	58,0 mm	- 69%
z-16	63,0 mm	- 66%
z-18	69,0 mm	- 64%
z-20	74,0 mm	- 63%

550 FT - ZEROATP150 - 550 FT

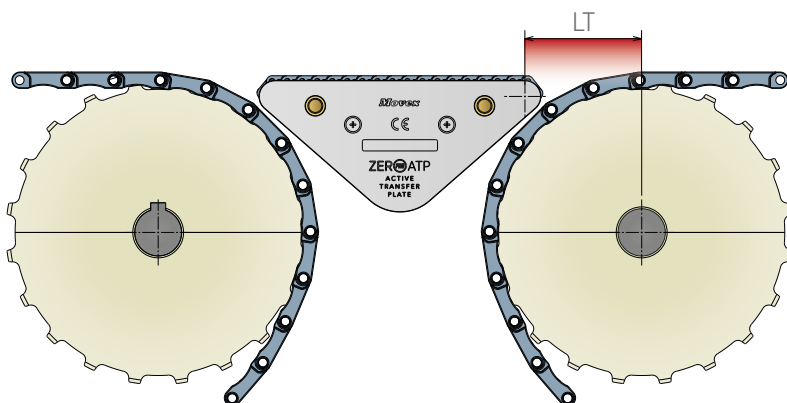

Z (n°of teeth)	LT	Δ%:
z-14	54,0 mm	- 71%
z-16	56,0 mm	- 70%
z-18	60,0 mm	- 69%
z-20	62,0 mm	- 68%

LT: Transfer length center to center (see page 26)

Δ%: Refers to a comparison between transfer with sprockets and transfer with Zero ATP® PRO.

*Transfer A, B, C can also be combined together to get different/shorter distances.

Valid also for: 551 FTT

551 FT - 551 FT

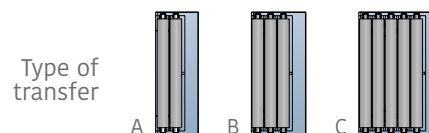
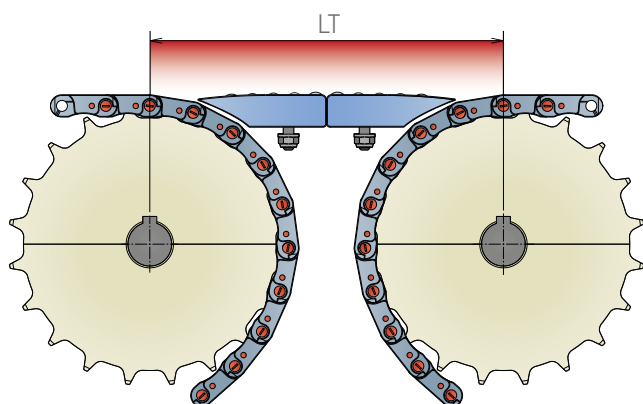

Z (n°of teeth)	LT	Type*
z-11	135,0 mm	B
z-14	190,0 mm	C
z-16	190,0 mm	C
z-18	198,0 mm	C
z-20	202,0 mm	C
z-21	204,0 mm	C

551 FT - ZEROATP80 - 551 FT

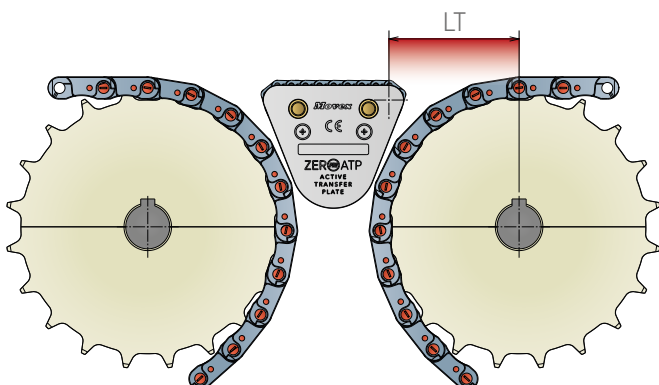

Z (n°of teeth)	LT	Δ%:
z-11	51,0 mm	- 62%
z-14	58,0 mm	- 69%
z-16	63,0 mm	- 66%
z-18	69,0 mm	- 65%
z-20	74,0 mm	- 63%
z-21	77,0 mm	- 62%

551 FT - ZEROATP150 - 551 FT

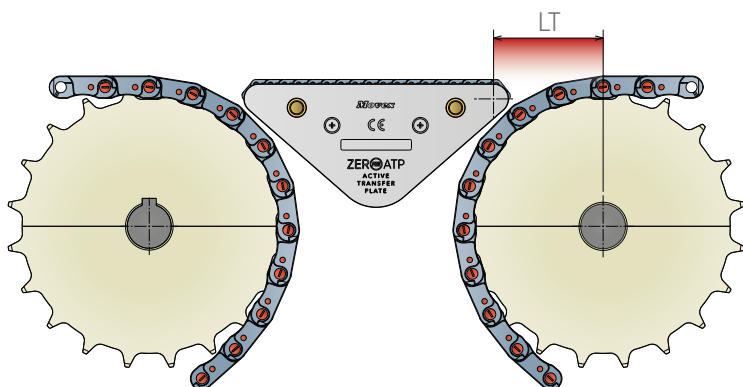

Z (n°of teeth)	LT	Δ%:
z-11	49,0 mm	- 63%
z-14	54,0 mm	- 71%
z-16	56,0 mm	- 70%
z-18	60,0 mm	- 69%
z-20	62,0 mm	- 69%
z-21	64,0 mm	- 68%

LT: Transfer length center to center (see page 26)

Δ%: Refers to a comparison between transfer with sprockets and transfer with Zero ATP® PRO.

*Transfer A, B, C can also be combined together to get different/shorter distances.

551 LBP - 551 LBP

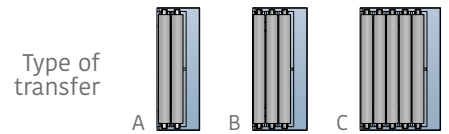
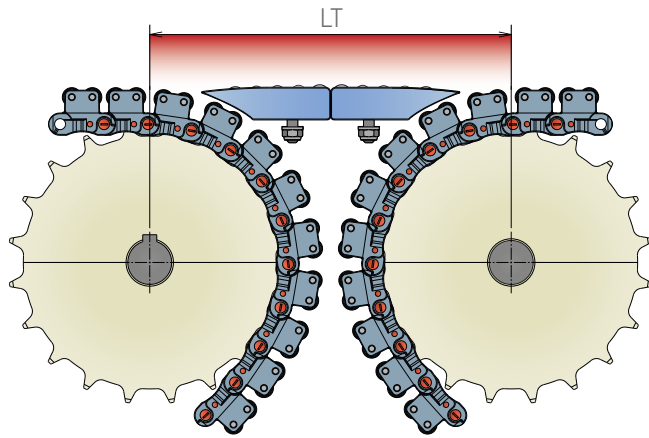

Z (n°of teeth)	LT	Type*
z-11	138 mm	B
z-14	194 mm	C
z-16	195 mm	C
z-18	206 mm	C
z-20	206 mm	C
z-21	208 mm	C

551 LBP - ZEROPRO ATP 80 - 551 LBP

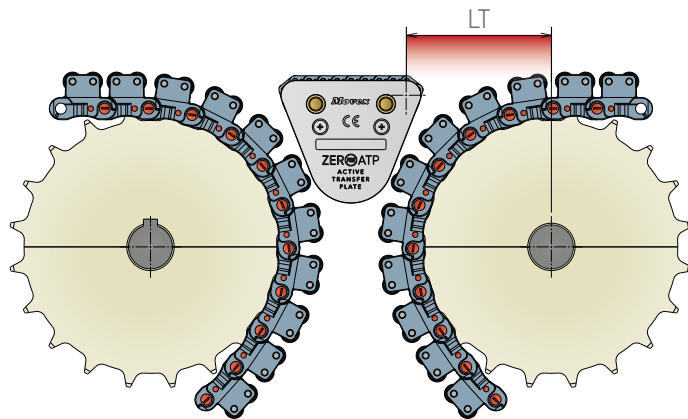

Z (n°of teeth)	LT	Δ%:
z-11	59,0 mm	- 57%
z-14	67,0 mm	- 65%
z-16	72,0 mm	- 63%
z-18	78,0 mm	- 37%
z-20	83,0 mm	- 59%
z-21	85,5 mm	- 58%

551 LBP - ZEROPRO ATP 150 - 551 LBP

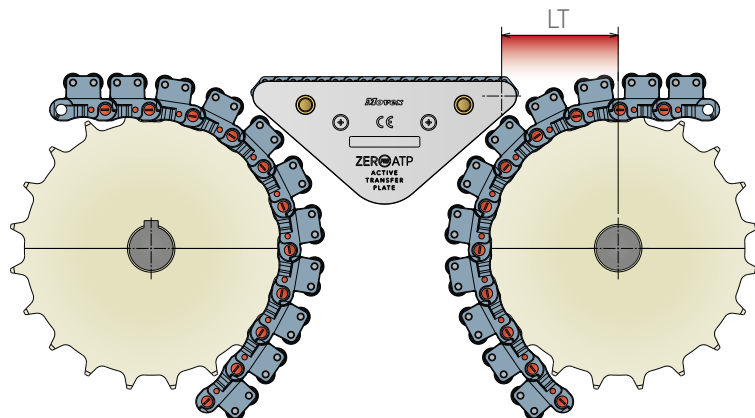

Z (n°of teeth)	LT	Δ%:
z-11	53 mm	- 61%
z-14	58 mm	- 69%
z-16	60 mm	- 69%
z-18	64 mm	- 69%
z-20	66 mm	- 68%
z-21	68 mm	- 67%

LT: Transfer length center to center (see page 26)

Δ%: Refers to a comparison between transfer with sprockets and transfer with Zero ATP® PRO.

*Transfer A, B, C can also be combined together to get different/shorter distances.

551 PRO LBP - 551 PRO LBP

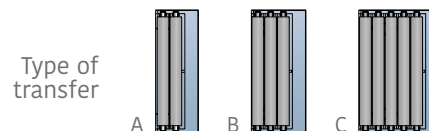
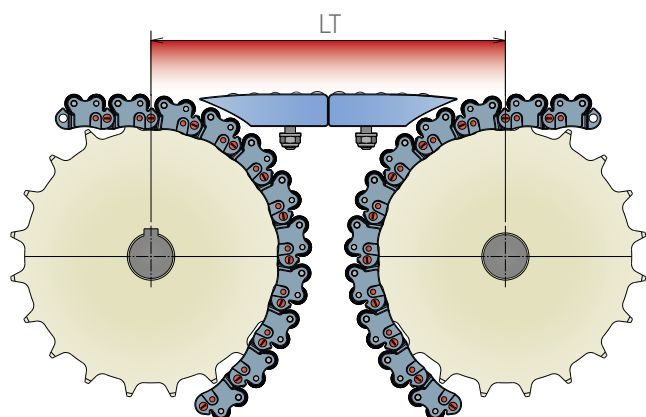

Z (n° of teeth)	LT	Type*
z-11	137,0 mm	B
z-14	190,0 mm	C
z-16	192,5 mm	C
z-18	200,0 mm	C
z-20	202,0 mm	C
z-21	204,0 mm	C

551 PRO LBP - ZEROATP 80 - 551 PRO LBP

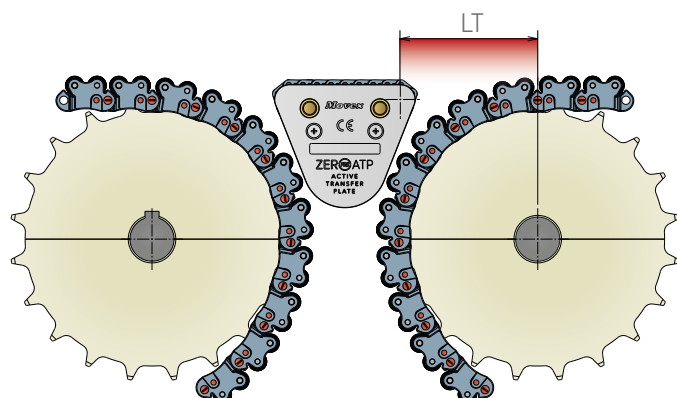

Z (n° of teeth)	LT	Δ%:
z-11	54,0 mm	- 60%
z-14	62,0 mm	- 67%
z-16	67,0 mm	- 65%
z-18	73,0 mm	- 63%
z-20	78,0 mm	- 61%
z-21	81,0 mm	- 60%

551 PRO LBP - ZEROATP 150 - 551 PRO LBP

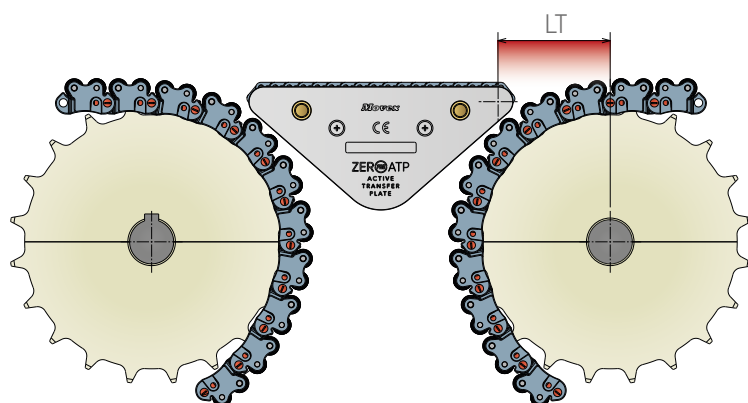

Z (n° of teeth)	LT	Δ%:
z-11	50,0 mm	- 63%
z-14	55,0 mm	- 71%
z-16	57,0 mm	- 70%
z-18	62,0 mm	- 69%
z-20	64,0 mm	- 68%
z-21	65,0 mm	- 68%

LT: Transfer length center to center (see page 26)

Δ%: Refers to a comparison between transfer with sprockets and transfer with Zero ATP® PRO.

*Transfer A, B, C can also be combined together to get different/shorter distances.

553 FLEXTOP - 553 FLEXTOP

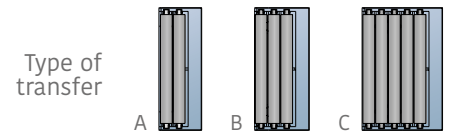
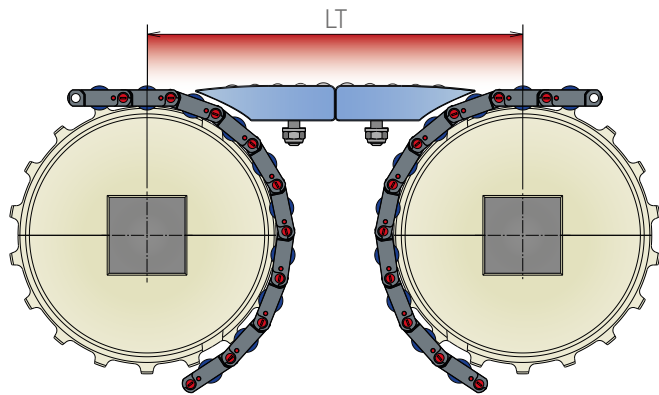

Z (n°of teeth)	LT	Type*
z-12	136,5 mm	B
z-15	191,5 mm	C
z-18	198,0 mm	C

553 FLEXTOP - ZERO ATP80 - 553 FLEXTOP

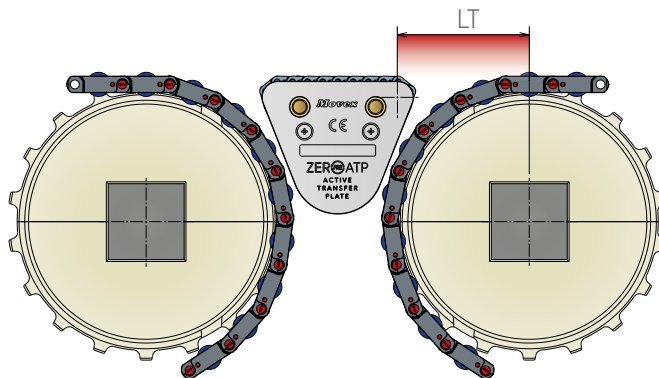

Z (n°of teeth)	LT	Δ%:
z-12	53,0 mm	-61%
z-15	62,0 mm	-67%
z-18	69,5 mm	-65%

553 FLEXTOP - ZERO ATP150 - 553 FLEXTOP

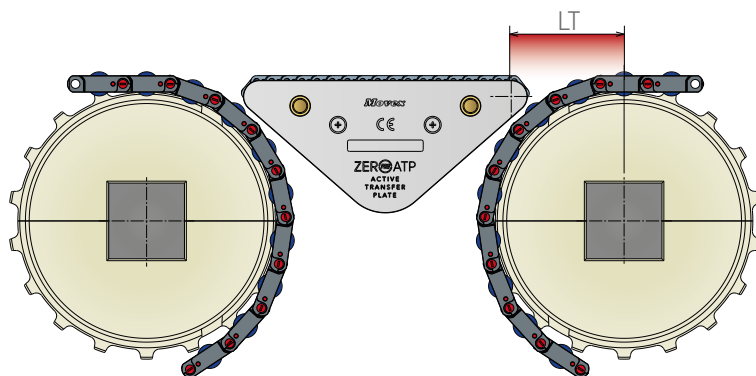

Z (n°of teeth)	LT	Δ%:
z-12	49,5 mm	-63%
z-15	55,0 mm	-71%
z-18	60,0 mm	-69%

LT: Transfer length center to center (see page 26)

Δ%: Refers to a comparison between transfer with sprockets and transfer with Zero ATP® PRO.

*Transfer A, B, C can also be combined together to get different/shorter distances.

556 FT - 556 FT

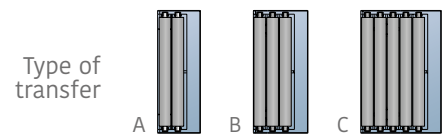
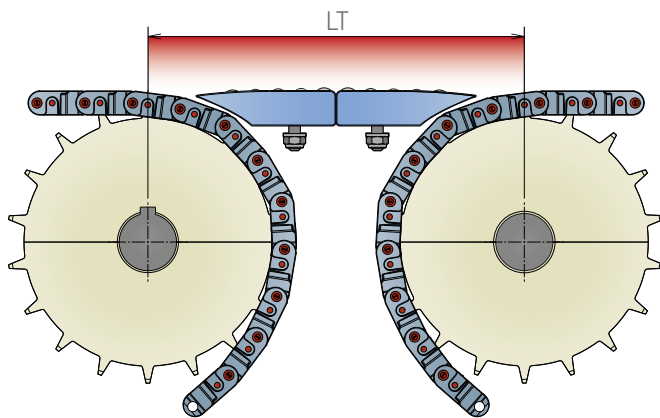

Z (n°of teeth)	LT	Type*
z-10	131,5 mm	B
z-12	142,0 mm	B
z-15	189,0 mm	C
z-18	197,0 mm	C

556 FT - ZEROATP 80 - 556 FT

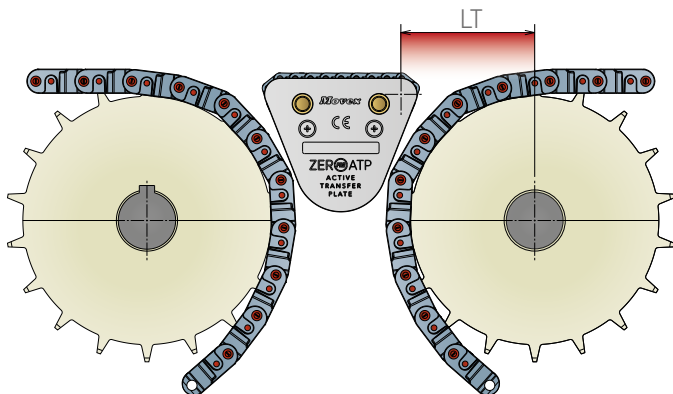

Z (n°of teeth)	LT	Δ%:
z-10	48,0 mm	-63%
z-12	55,0 mm	-61%
z-15	62,0 mm	-67%
z-18	70,0 mm	-64%

556 FT - ZEROATP 150 - 556 FT

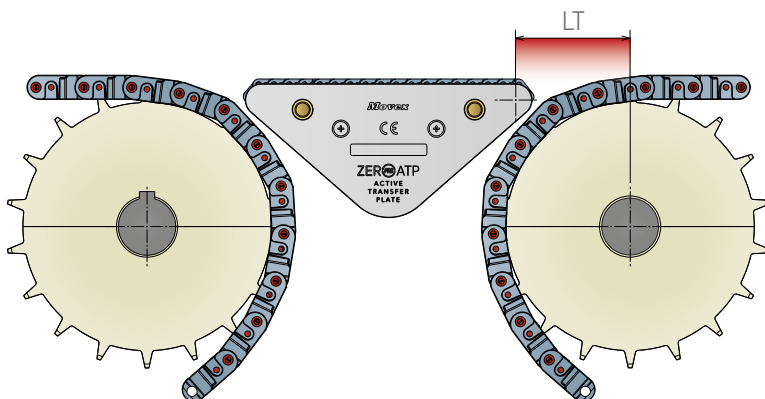

Z (n°of teeth)	LT	Δ%:
z-10	46,0 mm	-65 %
z-12	52,0 mm	-63 %
z-15	55,0 mm	-70%
z-18	60,0 mm	-69%

LT: Transfer length center to center (see page 26)

Δ%: Refers to a comparison between transfer with sprockets and transfer with Zero ATP® PRO.

*Transfer A, B, C can also be combined together to get different/shorter distances.

600 FT - 600 FT

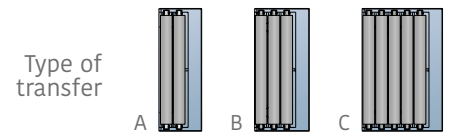
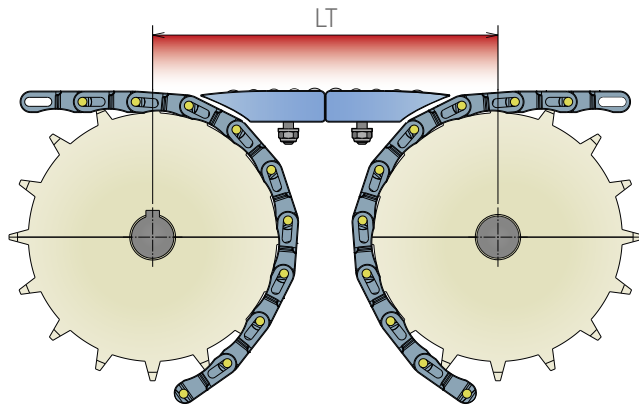

Z (n°of teeth)	LT	Type*
z-10	140,0 mm	B
z-13	191,0 mm	C
z-15	197,0 mm	C
z-16	204,0 mm	C

600 FT - ZEROATP80 - 600 FT

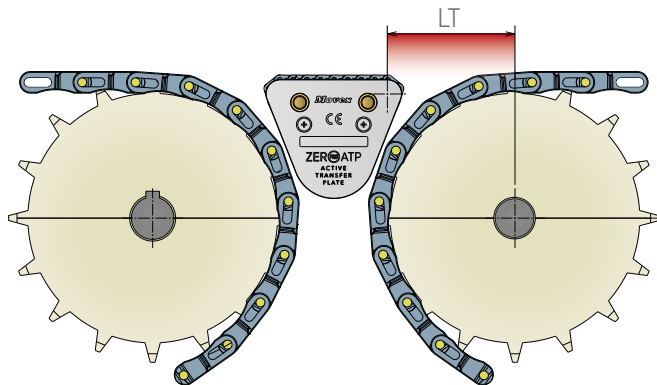

Z (n°of teeth)	LT	Δ%:
z-10	54,0 mm	-61%
z-13	64,0 mm	-66%
z-15	71,0 mm	-64%
z-16	75,0 mm	-63%

600 FT - ZEROATP150 - 600 FT

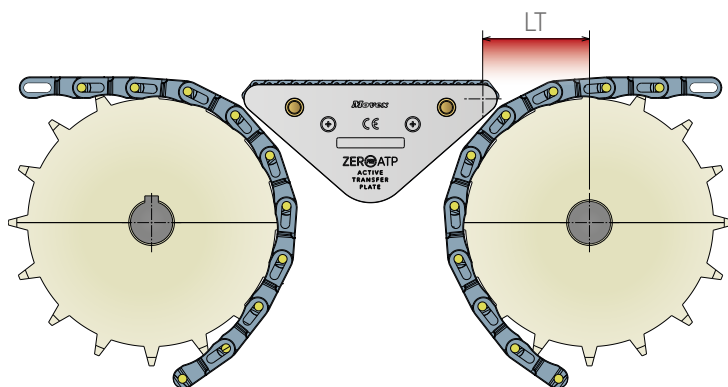

Z (n°of teeth)	LT	Δ%:
z-10	51,0 mm	-63 %
z-13	56,5 mm	-70 %
z-15	60,0 mm	-69 %
z-16	63,0 mm	-69 %

LT: Transfer length center to center (see page 26)

Δ%: Refers to a comparison between transfer with sprockets and transfer with Zero ATP® PRO.

*Transfer A, B, C can also be combined together to get different/shorter distances.

820 FT - 820 FT

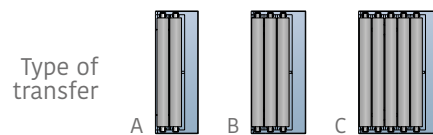
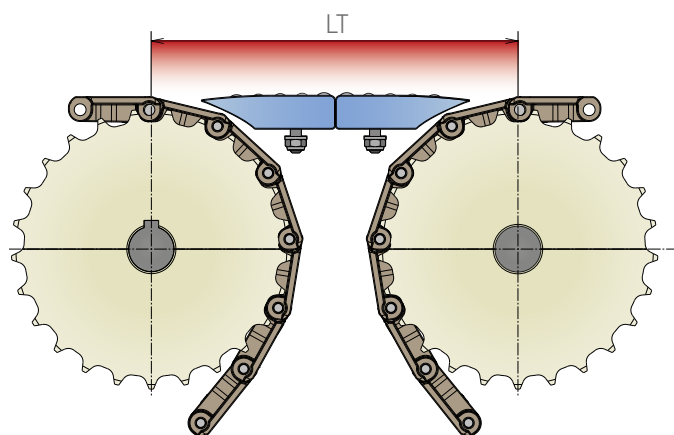

Z (n°of teeth)	LT	Type*
z-17	136,5 mm	B
z-19	190,0 mm	C
z-21	193,5 mm	C
z-23	197,0 mm	C
z-25	200,0 mm	C
z-27	202,0 mm	C
z-29	204,0 mm	C

820 FT - ZEROPRO ATP80 - 820 FT

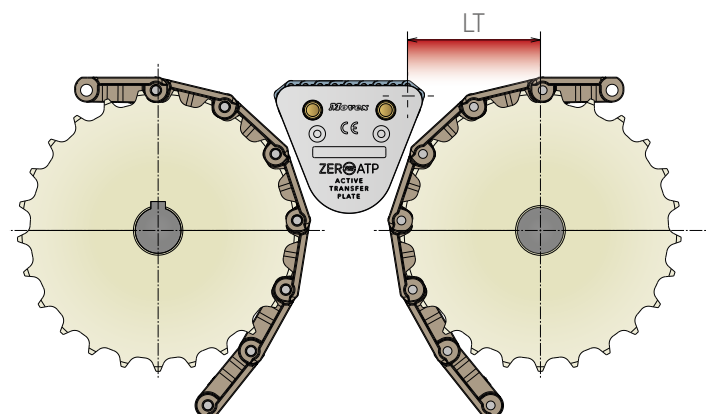

Z (n°of teeth)	LT	Δ%:
z-17	57,0 mm	-58 %
z-19	61,0 mm	-67 %
z-21	65,0 mm	-66 %
z-23	69,0 mm	-64%
z-25	73,0 mm	-63%
z-27	77,0 mm	-61%
z-29	81,0 mm	-60%

820 FT - ZEROPRO ATP150 - 820 FT

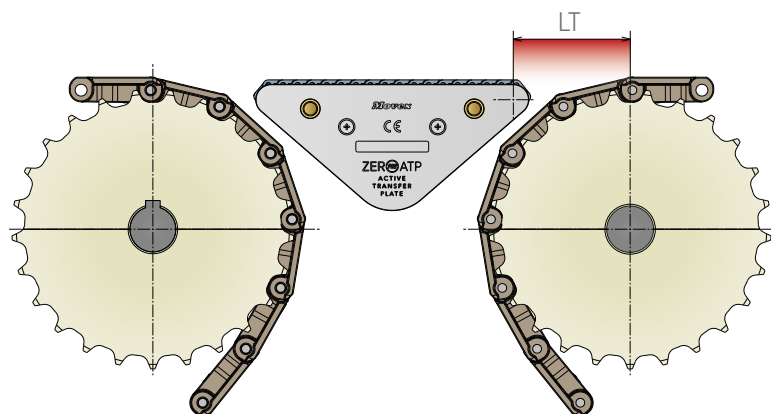

Z (n°of teeth)	LT	Δ%:
z-17	52,0 mm	-61%
z-19	55,0 mm	-71%
z-21	58,0 mm	-70%
z-23	60,0 mm	-69%
z-25	62,0 mm	-69%
z-27	64,0 mm	-68%
z-29	66,5 mm	-67%

LT: Transfer length center to center (see page 26)

Δ%: Refers to a comparison between transfer with sprockets and transfer with Zero ATP® PRO.

*Transfer A, B, C can also be combined together to get different/shorter distances.

821 LBP - 821 LBP

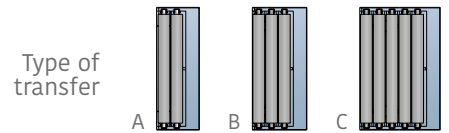
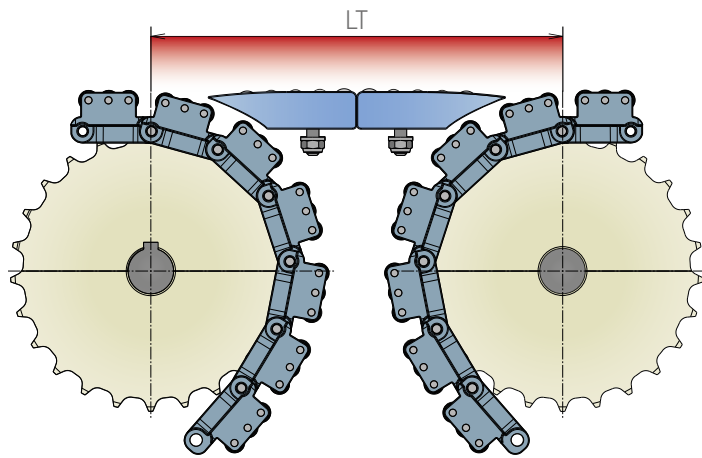

Z (n°of teeth)	LT	Type*
z-17	181,5 mm	C
z-19	196,0 mm	C
z-21	200,0 mm	C
z-23	204,0 mm	C
z-25	207,0 mm	C
z-27	209,0 mm	C
z-29	224,0 mm	C

821 LBP - ZEROATP80 - 821 LBP

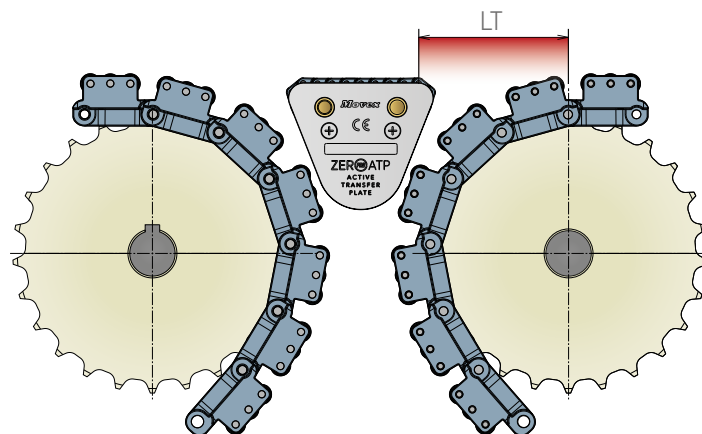

Z (n°of teeth)	LT	Δ%:
z-17	65,0 mm	-64%
z-19	69,0 mm	-64%
z-21	74,0 mm	-63%
z-23	78,0 mm	-61%
z-25	83,0 mm	-60%
z-27	86,0 mm	-58%
z-29	90,0 mm	-59%

821 LBP - ZEROATP150 - 821 LBP

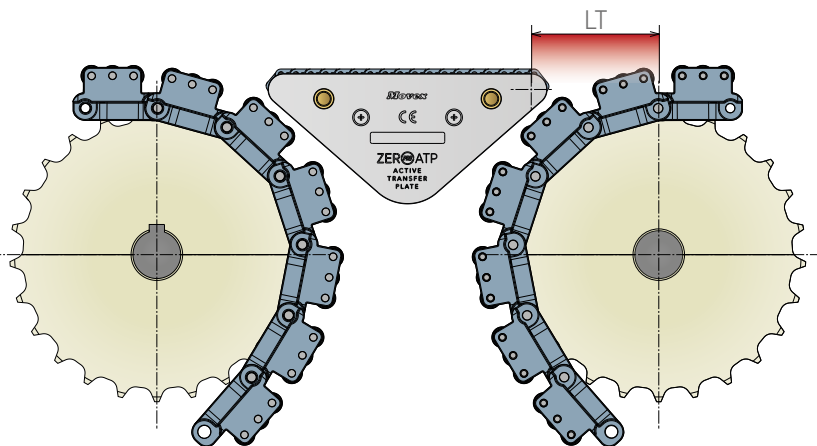

Z (n°of teeth)	LT	Δ%:
z-17	56,0 mm	-69%
z-19	58,0 mm	-70%
z-21	61,0 mm	-69%
z-23	63,0 mm	-69%
z-25	66,0 mm	-68%
z-27	68,0 mm	-67%
z-29	70,0 mm	-68%

LT: Transfer length center to center (see page 26)

Δ%: Refers to a comparison between transfer with sprockets and transfer with Zero ATP® PRO.

*Transfer A, B, C can also be combined together to get different/shorter distances.

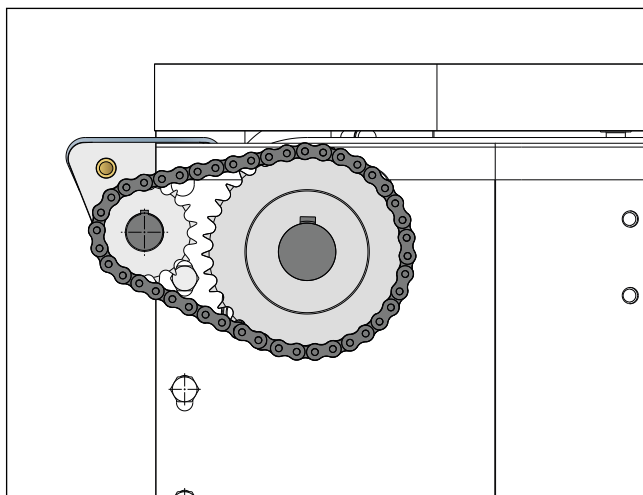

ROLLER CHAIN:

Suggested type of roller chain: 3/8 inch. The correct number of teeth both for drive and return sprockets needs to be calculated based on pitch diameters and required speed. All the information related to our sprocket pitch diameters (for modular belts and chains) are available in our General Catalog and General Engineering Manual. The pitch diameter for Zero ATP® PRO is always d.45mm.

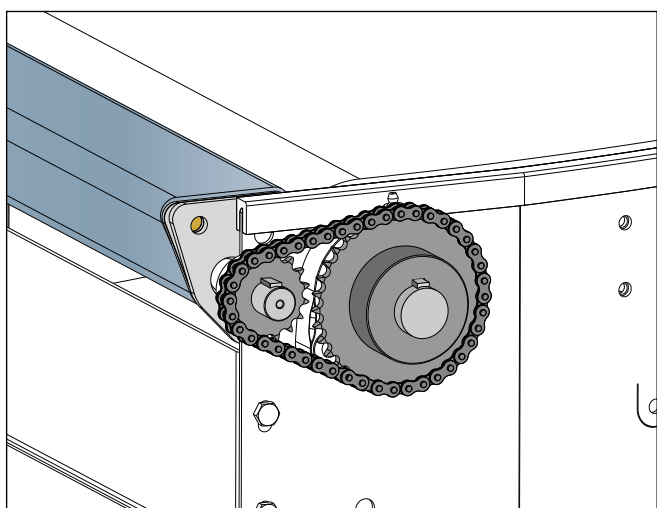

INSTALLATION:

While installing Zero ATP® PRO using a previous or following motor, be sure sprockets are installed correctly: check that they are not touching each other and that Zero ATP® PRO is not touching the previous and next conveyors. If so, positions need to be checked again. Try to keep always a minimum safety distance of 1,5mm between Zero ATP® PRO belt and previous or next conveyor belts. To be sure you can always adjust the distance and the height of the Zero ATP® PRO, we suggest making slotted holes.

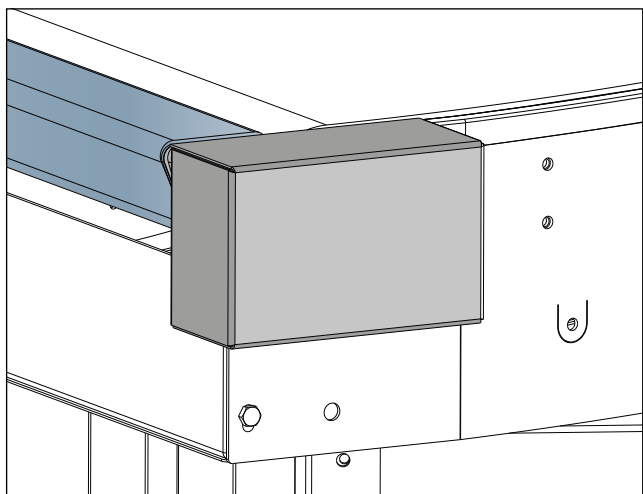

SAFETY COVER:

It is very important to protect the transmission with a safety cover, which will keep sprockets and roller chain safe from external agents that could damage them, as well as protect operators from possible injuries. Before proceeding with any maintenance or work on the transmission, be sure the conveyors are completely switched and that nobody can reactivate them while you are working on them.

In view of the experience gained over the years Movex S.p.A. advises you to wear personal protective equipment, during the maintenance, and placement of the conveyor:



Safety helmet to ensure head protection.



Safety shoes against the risk of slipping, impact, and falling objects.



Protective gloves against the risk of abrasions, cut etc...



The use of safety glasses is always advisable.

If chemicals that pose a health risk are used in the machine/installation, the user must take the necessary safety precautions. **The safety rules must be followed.**



Warning!

- During operation, adjustments and maintenance: always wear safety shoes.
- During operation, adjustment or maintenance: you must not be wearing any jewelry.
- Loose fitting clothing is very dangerous; secure or remove them.
- Keep long hair tied up and wear a safety helmet.
- Keep the work floor clean at all times.

		Assure that the conveyor is properly fixed before starting.		Be sure the conveyor is correctly levelled before starting-up.
		Respect the technical specifications.		Do not overload the belt.
		Assure proper fitting of all rods before starting the system (especially after first installation & maintenance of the belt).		Do not operate the system when rods are not properly in place.
		We suggest starting the belt slowly to check the correct operation and to avoid the stumbling points.		Do not start the conveyor before checking critical points of operation.
		We suggest using only warm water for compatible cleaning solutions or cleaning the belt.		Do not use strong chemicals such as chlorides, acids, etc for cleaning the belt.
		Pay attention to the conditions of the modular belt.		Do not operate when the belt is damaged.
		Keep the conveyor clean to prevent damage.		Do not climb on the conveyor.
		Zero ATP® PRO is the ideal solution for the food, and beverage processing industry.		Do not use the transfer to transport people or animals.
		Keep conveyor in temperature range under 60°.		Do not contact with open flame.

General maintenance instructions

Read the following recommendations before performing maintenance work.

- Keep the work area clean at all times.
- Keep the workbench clean and tidy.
- Keep the work area safe.
- Also be sure to carefully read all the manuals included in the package. They contain important information concerning adjustment, maintenance, maintenance intervals, electrical connections, etc.

Sprockets

Periodically check the wheels for wear and damage. The drive sprockets are worn when the flanks of the teeth are no longer identical (concave). In the case of extreme wear, it is recommended that both the drive wheels and the modular belt be replaced.

Bearings

All bearings must turn easily, with little noise and virtually no play. Furthermore, the bearings must not become too warm. If a bearing does not meet these requirements, it must be replaced.

Sprocket replacement

To replace the sprockets, the entire system has to be opened, as sprockets are inside the modules.

Have a work trolley or similar handy, on which you can place the parts you remove.

Follow these steps:

1. Remove the external sides by acting on the self threading screws
2. Divide the modular belt by pushing the pin out from the correct side. Use a drift pin.
Now the belt can be removed.
3. Remove the central threaded rod, remove the motor (if available) and slide out the shaft.
ATTENTION: by sliding out the shaft bearings and sprockets may fall down, so it is better to do the job on a table or desk.
4. Fit in reverse order.

Note: When connecting the modular belt, use a new connecting pin.

Wear and damage to the modular belt

For the initial start-up of this conveyor we suggest to run it slowly to allow a complete check of the running belt. You must check the modular belt for tension and wear during the first thirty days that the system is operational.

Wear and damage can occur due to the following (this is not an exhaustive list):

- The accumulation of contaminants.
- Belt tension that is too low or high.

After every 250 hours, the belt has to be checked to see if stretching is clearly visible, we recommend to remove one or more rows of modules if necessary.

Belt tensioning

The modular belt does not require an external tensioning device. Periodic check for damage to the modular belt:

- Check the belt (top and bottom sides), gears and wear strips for signs of wear or damage (cuts, grooves, etc.).
- Check the rods (remove at least two per section) for wear.
- Investigate the cause of any wear that occurs sooner than normal and plan time as soon as possible to readjust the belt or to take other corrective measures.

INSTALLATION ON THE LINE

Dismounting the belt:

- To install the Zero ATP® PRO on the line, the 4 lateral M8 bushings can be used. [1]
- If you bought it, the optional cover needs to be installed before the unit is fixed on the conveyor. [2]
- Before you fix the unit, be sure it is leveled at the correct height (we suggest keeping a distance H of 1-2mm). More information dedicated available at our engineering manual. Before you fix the unit, be sure it is positioned at a correct distance D between previous and next conveyor (we suggest a distance of minimum 1,5mm from the previous and next belt). [3]



Before proceeding to remove the rod, ensure that the belt ends cannot slip away due to its weight.

- A correct installation of the Zero ATP® PRO will leave gaps not bigger than 3-4mm (finger protection). [4]
- Before you start carrying products, please check eventual noise between the 3 belts, if so, some measures have not been respected. [5]
- Double check with your products if the height and the transfer is ok, if not, please repeat the operation. Based on the previous and next installed belt, wider products should not even touch the Zero ATP® PRO while the smaller ones should be perfectly transferred. For more information and dimensions related to the transfer, please consult our engineering manual or contact your sales representative. [6]
- Now you can fix it, and can let your Zero ATP® PRO running. [7]



Before proceeding to insert the rod, ensure that the belt ends cannot slip away due to its weight.

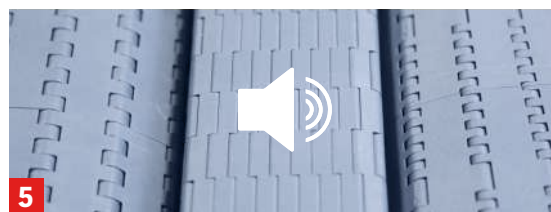
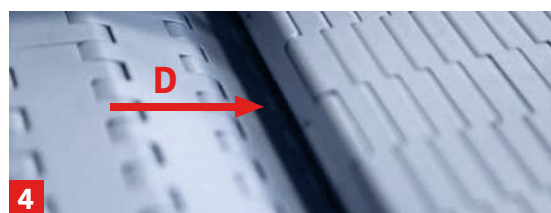
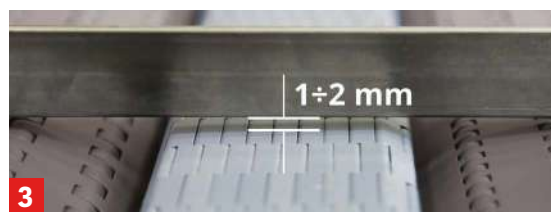
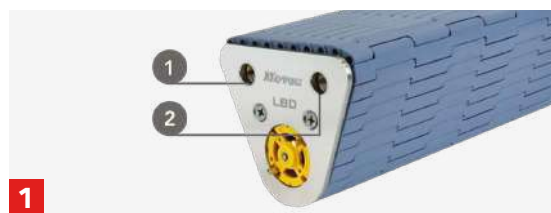

NOTE: When connecting the modular belt, use a new connecting pin.

INSPECTION

Maintenance is essential to keep the installation working properly. The maintenance and inspection schedule provided below can serve as a guideline.

Important! The following list applies to our standard conveyor. Separate inspection lists may be included for your project.

Description	Frequency			
	Weekly	Monthly	Quarterly	Annually
Mechanical (*)				
General visual inspection	X			
Guide strips (wear & damage)				X
Nose, roller transition, bearing bushes (**)				X
Modular belt (wear & damage)			X	
Modular belt (tension)			X	
Drive and return roller (bearings)				X
Sprockets (wear & damage)			X	X
Connections (bolts and nuts)		X		
Bearings (blocks)				X
Attachment of gear reduction motor			X	
Transfer (adjustment)				X
Machine safety provisions (**)				
Emergency stop	X			
External wiring	X			
Sensors & photocells (mounting, switching operation, cleanliness)			X	
Cleaning (***)		X		

(*) depending on the number of hours the installation is used for production

(**) if applicable

(***) depending on the degree of contamination and/or use of a conveyor cleaning system. If a conveyor cleaning system is installed, consult the supplier's manual for cleaning instructions.

For a better conveyor efficiency, cleanliness is an important factor to be considered. Normal cleaning with warm water is sufficient; in case of excessive dirt, non-aggressive detergents may be used. For more information about the compatibility between the material and the detergents, please check our engineering manual or contact your supplier.

Attention:

- in case of mini-motor version, do not flush directly on the electronical parts, water may compromise their functionality
- in case of key-shaft version, be sure that the chain is well regreased afterwards
- be sure hinges and pockets are well cleaned, dirty sections may compromise the unit functionality

Due to the wide range of materials and processing methods, the information provided in this manual should only be considered as guidelines, not as binding instructions. The overall procedure must be optimized for each individual case. In case of evident dirt still on the unit, it is suggested the use of pressure washer at a safety distance of 30cm, maximum pressure of 8 bar and maximum temperature of 60 °C or the use of compressed air.

For a deeper cleaning process, open the belt and blow the internal components; once it results visibly cleaned, the unit can be mounted again.

After completion of work on the installation, properly reinstall all the safety provisions (e.g. guards, emergency stop pull cords) in the correct manner and/or reconnect them.

NOTE:

Always consult the product-specific information and/or cleaning cards provided by the suppliers of cleaning agents. These include product-specific information, cleaning procedures and instructions for the safe use of these products. NEVER combine different cleaning agents!

Movex cannot be held responsible for improper use and application of cleaning products!

WARNING:

Only allow skilled personnel who are familiar with the applicable regulations and manual to perform work on the conveyor. Make sure the conveyor is completely switched off before you begin work on the conveyor. Make sure that others cannot activate the conveyor or the installation it is part of. You can accomplish this by placing padlocks on the isolating switches or by removing the fuses and placing a warning sign. To the extent possible, leave the safety provisions intact during the work activities.

Possible faults and failures are listed below. In case of faults unfixable with the following instructions, please contact our engineering department.

Malfunction	Possible cause	Possible solution
Conveyor does not run.	<ul style="list-style-type: none"> - No electrical power present - Switch is off 	<ul style="list-style-type: none"> - Check electrical installation - Turn the switch on
Crunching noise.	<ul style="list-style-type: none"> - Too little lubricant left in drive unit - Modular belt tensioned too tightly 	<ul style="list-style-type: none"> - Lubricate or replace drive unit - Tension the modular belt less tightly; see the instructions in this manual
The product stops at a moving belt or infeed point from another conveyor.	<ul style="list-style-type: none"> - Product gets stuck (on side guides) - Product gets stuck at transition 	<ul style="list-style-type: none"> - Check the conveyor at snag points - Reduce the size of the transition or install a powered transition
Sprockets do not run in the modular belt.	<ul style="list-style-type: none"> - Worn sprockets - Position of the sprockets on the shaft incorrect - Foreign object between belt and sprockets 	<ul style="list-style-type: none"> - Adjust sprockets - Remove object - Replace sprockets; inspect the belt
Vibration of the belt or evident wear.	<ul style="list-style-type: none"> - The gap between Zero ATP® PRO and next conveyor is not enough 	<ul style="list-style-type: none"> - Follow construction instruction provided
Modular belt do not run correctly	<ul style="list-style-type: none"> - Sprockets are not engaging belt's pockets - Modular belt tensioned not enough 	<ul style="list-style-type: none"> - Check sprocket position - Remove one row of modules to tension it correctly

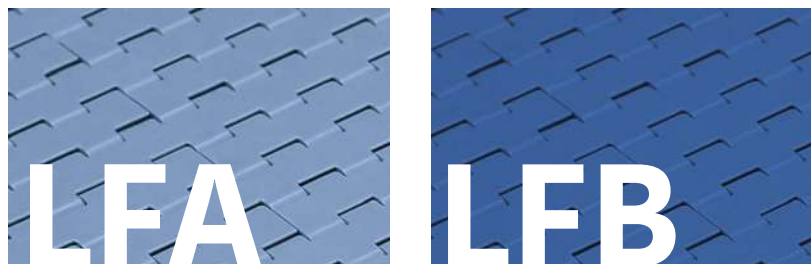

General information

Material	Chemical abbreviation	Allowable application temperatures						FDA Approval
		Fahrenheit			Celsius			
		Min	Max		Min	Max		
			Dry	Wet		Dry	Wet	
Low friction acetal	POM	-40	176	149	-40	80	65	YES

Friction Factors Between Material and Product

Lubrication	Product Material					
	Paper & carton	Metal (steel)	Aluminium	Plastics & PET	Glass(returnable)	Glass (new)
Dry	0,28	0,25	0,25	0,21	0,24	0,20
Water	n.a.	0,20	0,18	0,16	0,18	0,15
W&s & Dry lube	n.a.	0,15	0,14	0,13	0,14	0,12
Oil	n.a.	0,10	n.a.	n.a.	n.a.	n.a.

Friction Factors Between Material and Product

Lubrication	Wearstrip Material		
	Stainless steel	UHMW-PE & PA	BluLub®
Dry	0,24	0,20	0,18
Water	0,19	0,16	0,14
W&s & Dry lube	0,15	0,10	0,10
Oil	0,10	0,10	0,10

Note

Material properties and performance of final product are subject to variation according to operating conditions, e.g. environmental conditions, chemicals, cleanliness.

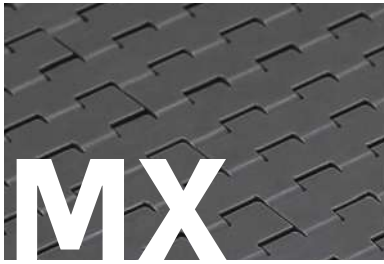

General information

Material	Chemical abbreviation	Allowable application temperatures						FDA Approval
		Fahrenheit			Celsius			
		Min	Max		Min	Max		
			Dry	Wet		Dry	Wet	
Performance PBT	PTB	-40	248	140	-40	120	60	YES

Friction Factors Between Material and Product

Lubrication	Product Material					
	Paper & carton	Metal (steel)	Aluminium	Plastics & PET	Glass(returnable)	Glass (new)
Dry	0,20	0,18	0,15	0,13	0,14	0,12
Water	n.a.	0,16	0,14	0,12	0,13	0,12
W&s & Dry lube	n.a.	0,13	0,12	0,10	0,11	0,10
Oil	n.a.	0,10	n.a.	n.a.	n.a.	n.a.

Friction Factors Between Material and Product

Lubrication	Wearstrip Material		
	Stainless steel	UHMW-PE & PA	BluLub®
Dry	0,20	0,16	0,13
Water	0,17	0,11	0,09
W&s & Dry lube	0,14	0,09	0,08
oil	0,10	0,10	0,10

Note
 Material properties and performance of final product are subject to variation according to operating conditions, e.g. environmental conditions, chemicals, cleanliness.

Questions? Look here

What is the maximum width feasible?

Zero ATP® PRO can be made to any width, based on your conveyor width.

Are there different lengths?

Zero ATP® PRO can be made in two different lengths, 80mm and 150mm.

For longer solutions, you can have a look to the Movex Zero ATP, available in length of 250mm and 500mm.

What is the maximum speed?

Speed depends on the version selected.

For the standard mini-motor version, maximum speed is 14,7 m/min.

For the keyed shaft version, speed can be higher, depending on the conveyor characteristic and product weight.

How to connect the Zero ATP® PRO to an existing drive?

Zero ATP® PRO keyed version can be easily driven by using a roller chain transmission.

It's always suggested to take the motion from the previous - drive - conveyor.

Can we find all possible transfer sketches on this manual?

There are hundreds of possible transfer sketches that can be created with our belts/chains and the Zero ATP® PRO.

This manual is showing the main belts/chains in combination with NoseBars or Sprockets.

For more information about possible transfer solutions, please contact our Engineering Department.

How can we understand related sprockets?

Movex Engineering manual contains all required information to understand corresponding belt/sprockets.

Moreover, Zero ATP® PRO module's pockets have molded the same number of the corresponding sprocket, so to be easily identified during installation.

Are spare parts available?

Yes, Moves always provide a maintenance manual with each Zero ATP® PRO shipped. Moreover, all parts shown in the Movex engineering manual can be quoted, for more information please ask your sales representative or send us an email at info@movexii.com



movexii.com

M999584 | 03/22

ENGINEERING MANUAL

Movex[®]

Movex S.p.A. | Headquarter
Viale Industria, 22
24060 Castelli Calepio (BG)

P +39 035 8359711
F +39 035 4420873

Movex S.p.A. | Logistics Center
Via Repubblica, 25
24060 Castelli Calepio (BG)

info@movexii.com
www.movexii.com

Movex around the world

Movex GmbH
P +49-6204-9375-0

Movex UK Ltd.
P +44-77-20678442

Movex Brasil Ltda
P +55-15-3141-2550

Movex Nederland
P +31-630-994850

Movex France
P +39-335-8085980

Movex USA Inc.
P +1-919-274-5477

Movex AG India
P +91-120-4159660-62

Movex SA de CV
P +52-1-3318458187

Movex Russia
P +7 (495) 925-88-56

Movex CIS Countries
P +380-667507756