



We extrude for your business.

Movex® is a dynamic and flexible business reality that have been active in the industrial production for over ten years and is reaching market leadership as a reliable and precise supplier, planning the future without losing sight of its history and the values that allow its growth.

In the dedicated extrusion center from our production plant in Castelli Calepio (Italy), **Movex®** provides a new generation of high-performing profiles, developed and produced with the most updated technologies. Experienced engineers work around the clock on more than 50 extrusion machines (horizontal and vertical) to perfect almost 2000 high quality products for our customer needs.

Movex® meets your needs for standard and custom made products in a dynamic and responsive way, ensuring the best performance to satisfy our customer requirements.

Choose the one that best suits you.

Each of the hundreds **Movex®** profiles are produced from a first rate of **UHMW-PE** with the possibility to further enhance performance by using our patented materials **BluLub®** and **Titanium White®**.

Transportation is a delicate phase for your shipment; to ship your order we choose the correct protection: carton, coils, reinforced wooden crate, packaging varies depending on the article typology, its size and its weight.

Standard or customized extrusion...your choice.

Movex® is driven by the will to design and manufacture top quality items, combining technical performance and design, in order to offer its customers a tailor made service.

Beside of the standard available profiles, **Movex®** is also developing together with the customer innovative special solutions to offer *“the product you need when you need it”* against an attractive price. We have organized a specific workflow, developed over the course of the last ten years, which aims to satisfy the requirements of even the most demanding buyer. Get in touch with us and ask a personalised quotation.

Choose the performance of innovative material.

BluLub® is the Movex super-performance compounded Ultra High Molecular Weight Polyethylene material, with the latest generation of solid lubricants, able to contribute improving PV-properties (limiting pressure velocity) compared to standard UHMW-PE, especially in applications with limited lubrication, higher speeds and/or higher loads.

BluLub® ensures high wear and abrasion resistance, requires less energy and with the lowest coefficient of friction, improves the product stability and wear life of sliding parts.

Thanks to the **BluLub®** characteristics, the extruded profiles can also offer a longer wear life, compared to traditional materials, and will help reducing marks over products or goods sliding on them; at the same time, **BluLub®** is also ideal for extreme conditions in terms of load and speed.

More material information and technical data sheet can be provided on request, get in touch with us for a quick support.

The right choice for:

- Lowest coefficient of friction
- Reduced noise and squeaking
- Lowest wear and minimized energy consumption
- Minimal moisture absorption
- Extreme material performances
- Best lubricant distribution

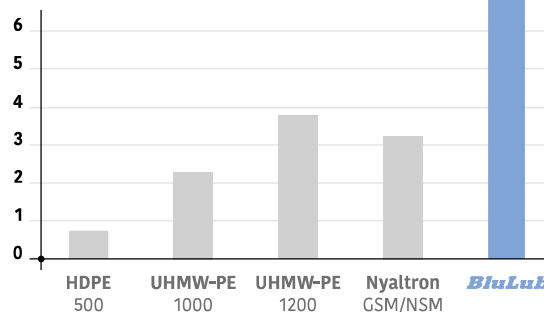
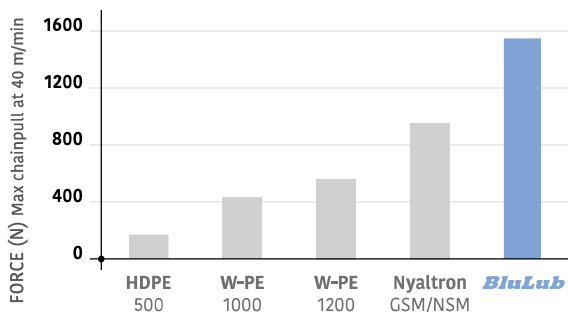
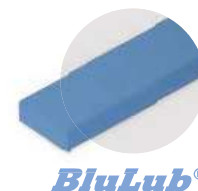

BluLub® is available for any type of profile, standard or custom.

Properties:

- UHMW-PE Polyethylene with molecular density 9,200,000 g/mol.
- Operating temperature: -40 to + 80°C (-40 to 176°F)
- Linear expansion coefficient: $2 \times 10^{-4} \text{ } ^\circ\text{C}^{-1}$ ($1.1 \times 10^{-4} \text{ } ^\circ\text{F}^{-1}$)



Titanium White®

High quality, bright white extrusions.

Titanium White® is the latest addition in the Movex's extrusion compound family. The name **Titanium White®** refers to the special metal because it has comparable unique properties, like high strength and optimum performance, generating low friction, absorbing heat and reducing energy consumption.

Titanium White® has a long lasting bright white color and keeps performances also after many hours of work. Thanks to the **Titanium White®** characteristics, the extruded profiles are made of an intense white UHMW-PE, resulting in a smoother surface and devoid of push marks, meaning in a minimized power consumption and possible goods defect. **Titanium White®** has also an improved UV and aging resistance and a high chemical resistance.

More material information and technical datasheets can be provided on request, get in touch with us for a quick support.

The right choice for:

- Lower coefficient of friction
- Lower wear and less energy consumption
- Minimal moisture absorption
- UV & aging resistance
- High chemical resistance



Ti-White®

22 3d²4s²



Titanium

47.867

Strong metal with low density that is quite ductile, lustrous and metallic white in color.

All these features reflect our extruded profiles with **Ti-White** compound.



Ti-White (Example of application)

Titanium White® is available for any type of profile, standard or custom.

Properties:

- UHMW-PE Polyethylene with molecular density 9,200,000 g/mol.
- Operating temperature: -40 to + 80°C (-40 to 176°F)
- Linear expansion coefficient: $2 \times 10^{-4} \text{°C}^{-1}$ ($1.1 \times 10^{-4} \text{°F}^{-1}$)



UHMW-PE

Standard extrusion polyethylene.

Standard profiles are all made with a first-rate **UHMW-PE** polyethylene, a thermoplastic polymer with a variable crystalline structure with a vast range of applications.

UHMW-PE is available in several colors and lengths. It's the perfect choice to reach your line-performance against an attractive price.



The right choice for:

- Low coefficient of friction
- Good resistance to wear consumption
- Attractive market price
- Long durability

Standard colors*:



Black

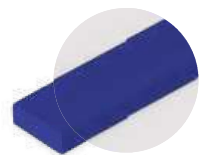

Blue

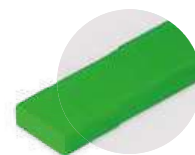

Green

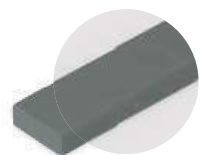

Grey

UHMW-PE is available for any type of profile, standard or custom.

Properties:

- UHMW-PE Polyethylene with molecular density 5,600,000 g/mol.
- Operating temperature: -40 to + 80°C (-40 to 176°F)
- Linear expansion coefficient: $2 \times 10^{-4} \text{ } ^\circ\text{C}^{-1}$ ($1.1 \times 10^{-4} \text{ } ^\circ\text{F}^{-1}$)

*Other colors are available on request.

Material selection

Movex offers different materials and design solution for each customer requirements. These comparison tables help to better understand each material and take advantage of their strengths and features to suit your specific needs:

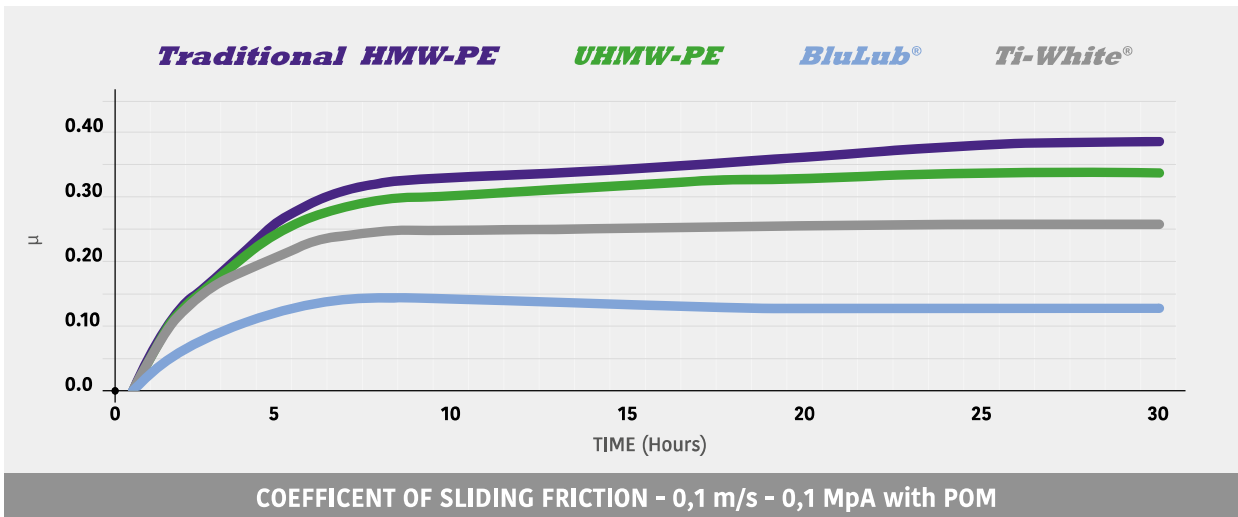
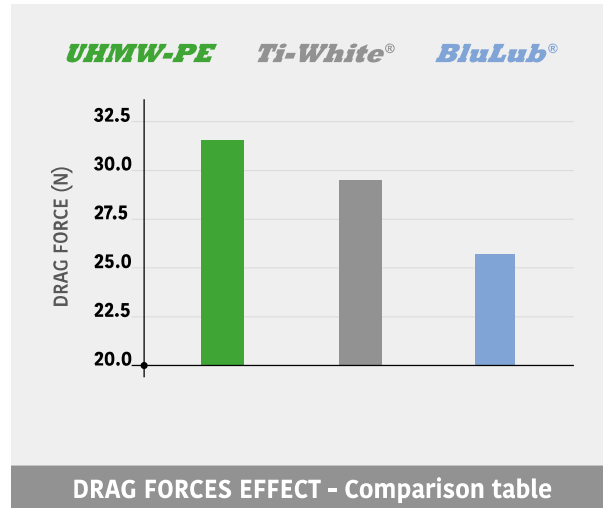
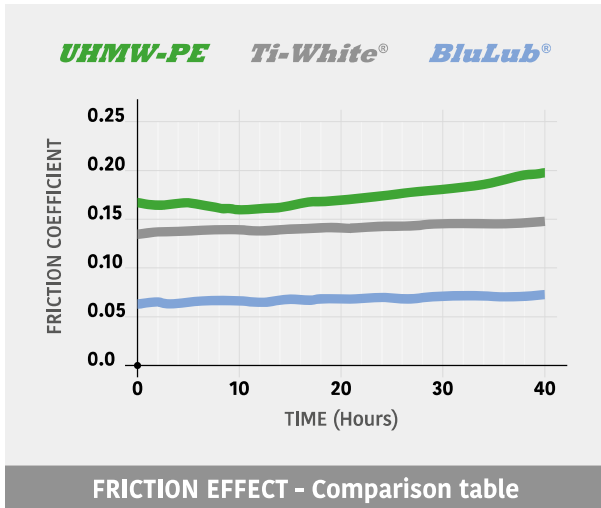

Ti-White® VS Traditional HMW-PE



This material can keep its color properties stable during the time. Moreover, titanium gives better sliding properties than traditional material.

BluLub® VS Traditional HMW-PE



Thanks to the unique solid lubricant added into the material, the sliding properties are excellent and energy consumption will be reduced.

RS SIDE GUIDE RAIL

Easy and modular replacement label saver system.

RS Side guide profile is a development which enable you to simplify your business!

Thanks to the replaceable wear-strip in **BluLub®**, **RS Side guide profile** can reduce total cost of ownership: in case of required maintenance, only **BluLub®** strips can be replaced, saving time at a lower cost.

Different profiles are available from stock and can be mounted in different ways to optimize the support of your product according to the specific needs.



Increased performance

BluLub® wearstrips contribute to a lower friction which results in less energy consumption.



Fast and easy maintenance

Thanks to its innovative design, the easy replaceable **BluLub® wearstrips** meets the needs to reduce maintenance time.



Interchangeable wearstrip

Every **BluLub® wearstrip** has the same fixing system, this makes all versions interchangeable. In case of required replacement, wearstrips can be ordered as coiled spare parts.



No gap between connection

BluLub® wearstrip allows you to connect two or more different base profiles with no gap, by simply slide it in.

The right choice for:

- Innovative equipment
- Total cost reduction
- Less energy consumption
- Improved product stability

RS Side guide rail profiles

are available in various executions.

Materials:

- Base profile: **UHMW-PE** (see details).
- Label saver: **BluLub®** polyethylene UHMW-PE with molecular density 9,200,000 g/mo. with reduced coefficient of friction and higher wear resistance and its complies with the code of Federal Regulations of FDA (see details).

Side guide rail USED WITH PLATE

See product page for specific details and materials available.

1063
Fit on mm
30 x 4

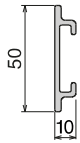

Pag 392

137
Fit on mm
40 x 8

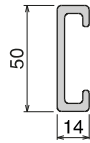

Pag 392

137
Fit on mm
40 x 10

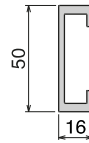

Pag 393

158
Fit on mm
40 x 10

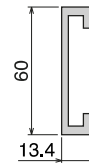

Pag 393

1064
Fit on mm
55 x 4

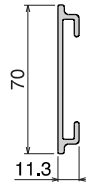

Pag 394

183
Fit on mm
40 x 8

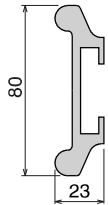

Pag 394

158
Fit on mm
50 x 6

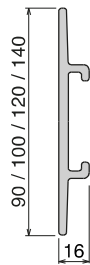

Pag 395

194 Label saver
Fit on mm
50 x 6



Pag 395

189
Fit on mm
40 x 8

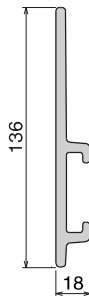

Pag 396

189 Label saver
Fit on mm
40 x 8

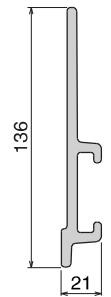

Pag 396/397

1079 RS
Fit on mm
40 x 8

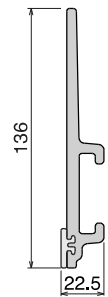

Pag 397

1079 RS
Fit on mm
40 x 8

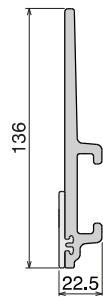

Pag 397

189
Fit on mm
50 x 6

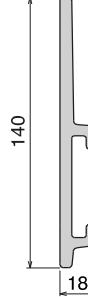

Pag 398

189 Label saver
Fit on mm
50 x 6

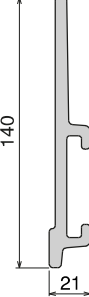

Pag 398/399

1096
Fit on mm
50 x 5

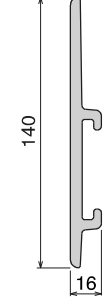

Pag 399

Side guide rail USED WITH PLATE AND CLAMP See product page for specific details and materials available.

135
Fit on mm
60 x 6

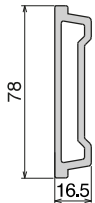

Pag 400

136
Fit on mm
60 x 6

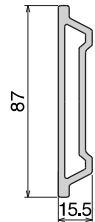

Pag 400

1057
Fit on mm
50 x 6

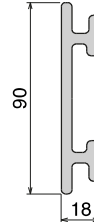

Pag 401

1077 Label saver
Fit on mm
50 x 6

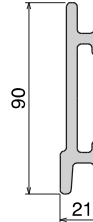

Pag 401

1077 RS
Fit on mm
50 x 6

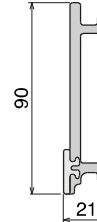

Pag 402

1078 RS
Fit on mm
50 x 6

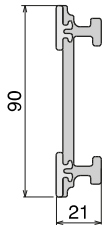

Pag 402

1057
Fit on mm
60 x 6

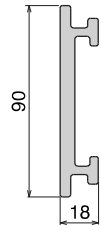

Pag 403

1077 Label saver
Fit on mm
60 x 6

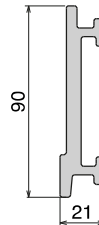

Pag 403

1077 RS
Fit on mm
60 x 6

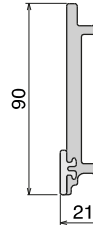

Pag 404

1078 RS
Fit on mm
60 x 6

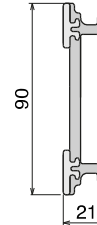

Pag 404

193
Fit on mm
60 x 5

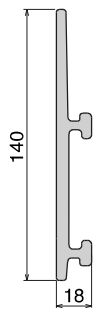

Pag 405

189
Fit on mm
60 x 5

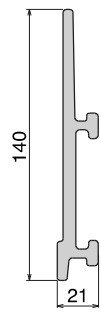

Pag 405/406

193
Fit on mm
60 x 6

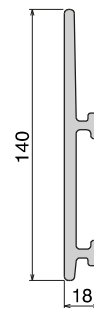

Pag 407

189 Label saver
Fit on mm
60 x 6

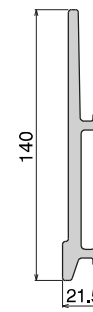

Pag 407/408

1075 RS
Fit on mm
60 x 6



Pag 408

187
Fit on mm
60 x 6

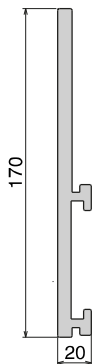

Pag 409

187 Label saver
Fit on mm
60 x 6

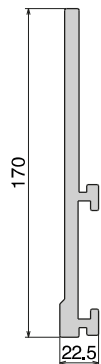

Pag 409

117
Stainless steel
Fit on mm
40 x 6
40 x 8
40 x 10



Pag 410

1055
Stainless steel
Fit on mm
40 x 8
50 x 6



Pag 410

159 - 1088 - 1089
Stainless steel
Fit on mm
50 x 6
60 x 5
60 x 6



Pag 410

1063 Guida laterale / Side guide / Seitenführung

Delivery: **Easy** **Standard** Fit on 30 x 4 mm

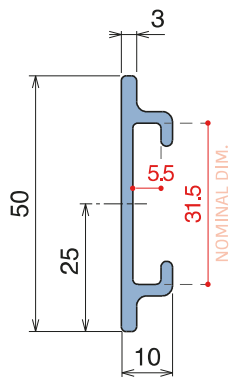
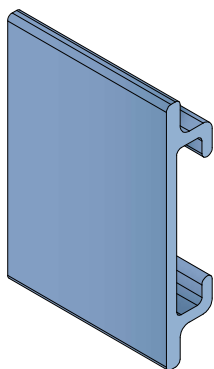

| Article-Nr. | Material | Availability | Supply |
|-------------|---------------|--------------|----------|
| 106300BC | BluLub | On request | 3 m bars |
| 106301C | Black | Stock item | 3 m bars |
| 106302C | Green | Stock item | 3 m bars |

Plate
30 x 4 mm



Option of application - Plate

137 Guida laterale / Side guide / Seitenführung

Delivery: **Easy** **Standard** Fit on 40 x 8 mm

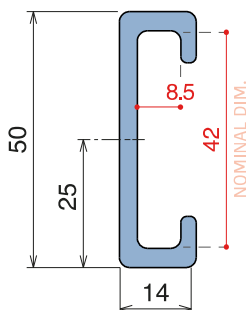
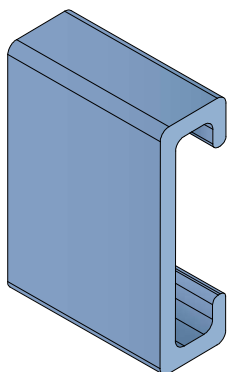

| Article-Nr. | Material | Availability | Supply |
|-------------|-----------------|--------------|----------|
| 13701BC | BluLub | Stock item | 3 m bars |
| 13701B | BluLub | On request | 6 m bars |
| 13703C | Ti-White | Stock item | 3 m bars |
| 13703 | Ti-White | On request | 6 m bars |
| 13702C | Black | Stock item | 3 m bars |
| 13702 | Black | On request | 6 m bars |
| 13705C | Blue | On request | 3 m bars |
| 13705 | Blue | On request | 6 m bars |
| 13701C | Green | Stock item | 3 m bars |
| 13701 | Green | Stock item | 6 m bars |

Plate
40 x 8 mm



Option of application - Plate

Part 117
Pag 410



Option of application - M-Profile

Part 1055
Pag 410



Option of application - Guide

137 Guida laterale / Side guide / Seitenführung

Delivery: **Easy** **Standard** Fit on 40 x 10 mm

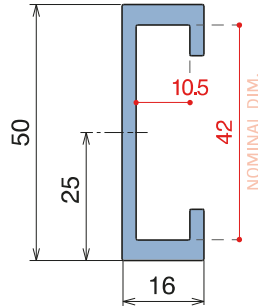
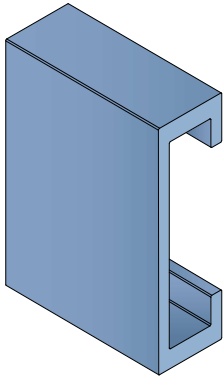

| Article-Nr. | Material | Availability | Supply |
|----------------|-----------------|--------------|----------|
| 13711BC | BluLub | Stock item | 3 m bars |
| 13711B | BluLub | On request | 6 m bars |
| 13713C | Ti-White | On request | 3 m bars |
| 13713 | Ti-White | On request | 6 m bars |
| 13712C | Black | On request | 3 m bars |
| 13712 | Black | On request | 6 m bars |
| 13715C | Blue | On request | 3 m bars |
| 13715 | Blue | On request | 6 m bars |
| 13711C | Green | Stock item | 3 m bars |
| 13711 | Green | Stock item | 6 m bars |

Plate
40 x 10 mm

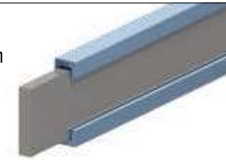

Option of application - Plate

Part 117
Pag 410



Option of application - M-Profile

158 Guida laterale / Side guide / Seitenführung

Delivery: **Easy** **Standard** Fit on 40 x 10 mm

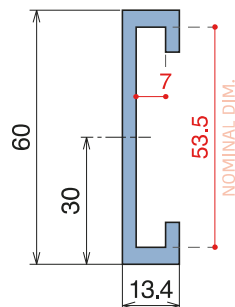
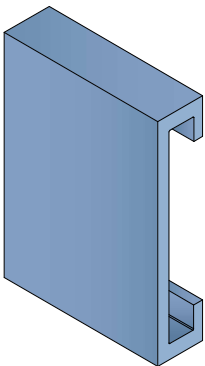

| Article-Nr. | Material | Availability | Supply |
|-----------------|-----------------|--------------|----------|
| 15800BC | BluLub | Stock item | 3 m bars |
| 15894C | Ti-White | On request | 3 m bars |
| 15898C | Black | Stock item | 3 m bars |
| 15894BLC | Blue | On request | 3 m bars |
| 15897C | Green | Stock item | 3 m bars |
| 15800C | Grey | Stock item | 3 m bars |

Plate
40 x 10 mm



Option of application - Plate

Part 159
Pag 410



Option of application - Guide

1064 Guida laterale / Side guide / Seitenführung

Delivery: **Easy** **Standard** Fit on 55 x 4 mm

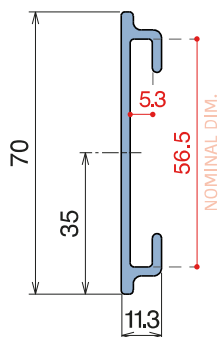
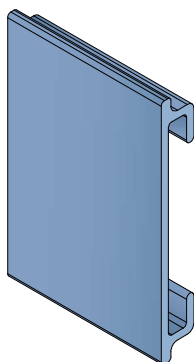

| Article-Nr. | Material | Availability | Supply |
|-------------|----------|--------------|----------|
| 106400BC | BluLub | On request | 3 m bars |
| 106403C | Ti-White | On request | 3 m bars |
| 106401C | Black | Stock item | 3 m bars |
| 106405C | Blue | On request | 3 m bars |

Plate
55 x 4 mm



Option of application - Plate

183 Guida laterale / Side guide / Seitenführung

Delivery: **Easy** **Standard** Fit on 40 x 8 mm

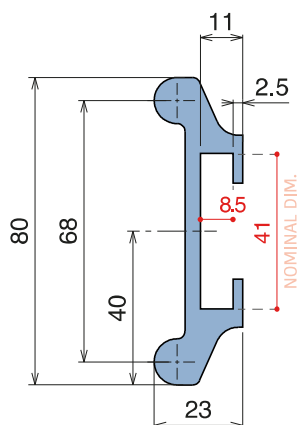
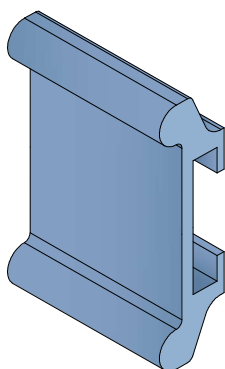

| Article-Nr. | Material | Availability | Supply |
|-------------|----------|--------------|----------|
| 18301BC | BluLub | Stock item | 3 m bars |
| 18301C | Black | Stock item | 3 m bars |
| 18305C | Blue | On request | 3 m bars |
| 18397C | Green | Stock item | 3 m bars |

Plate
40 x 8 mm



Option of application - Plate

Part 117
Pag 410



Option of application - M-Profile

Part 1055
Pag 410



Option of application - Guide

NEW

158

Guida laterale / Side guide / Seitenführung

Delivery: **Easy** **Standard** Fit on 50 x 6 mm

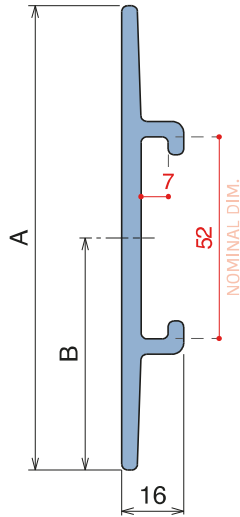
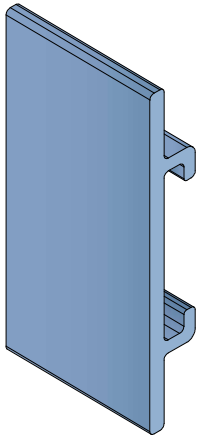

| Article-Nr. | A | B | Material | Availability | Supply |
|-------------|-----|----|----------|--------------|----------|
| 15801BC | 90 | 45 | BluLub | Stock item | 3 m bars |
| 15802BC | 100 | 50 | BluLub | Stock item | 3 m bars |
| 15803BC | 120 | 60 | BluLub | Stock item | 3 m bars |
| 15804BC | 140 | 70 | BluLub | On request | 3 m bars |
| 15831C | 90 | 45 | Ti-White | On request | 3 m bars |
| 15832C | 100 | 50 | Ti-White | On request | 3 m bars |
| 15833C | 120 | 60 | Ti-White | On request | 3 m bars |
| 15834C | 140 | 70 | Ti-White | On request | 3 m bars |
| 15801BLC | 90 | 45 | Blue | On request | 3 m bars |
| 15802BLC | 100 | 50 | Blue | On request | 3 m bars |
| 15803BLC | 120 | 60 | Blue | On request | 3 m bars |
| 15804BLC | 140 | 70 | Blue | On request | 3 m bars |
| 15801C | 90 | 45 | Grey | Stock item | 3 m bars |
| 15802C | 100 | 50 | Grey | Stock item | 3 m bars |
| 15803C | 120 | 60 | Grey | Stock item | 3 m bars |
| 15804C | 140 | 70 | Grey | On request | 3 m bars |

Plate
50 x 6 mm



Option of application - Plate

Part 159
Pag 410

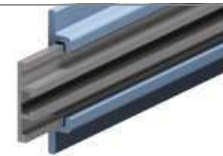

Option of application - Guide

NEW

194

Guida laterale con salva etichetta / Side guide with lable saver / Seitenführung mit Etikettenschutz

Delivery: **Easy** **Standard** Fit on 50 x 6 mm

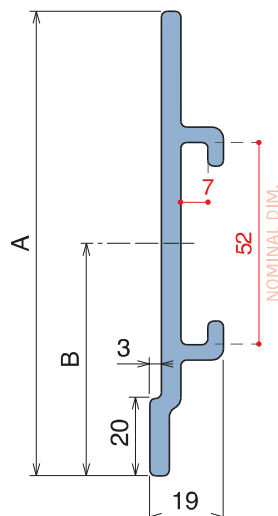
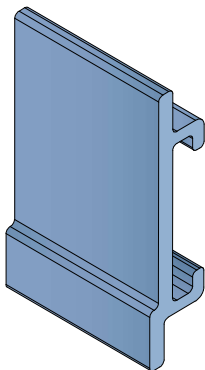

| Article-Nr. | A | B | Material | Availability | Supply |
|-------------|-----|----|----------|--------------|----------|
| 19400BC | 90 | 45 | BluLub | Stock item | 3 m bars |
| 19403BC | 120 | 60 | BluLub | Stock item | 3 m bars |
| 19430C | 90 | 45 | Ti-White | On request | 3 m bars |
| 19433C | 120 | 60 | Ti-White | On request | 3 m bars |
| 19400BLC | 90 | 45 | Blue | On request | 3 m bars |
| 19403BLC | 120 | 60 | Blue | On request | 3 m bars |
| 19400C | 90 | 45 | Grey | On request | 3 m bars |
| 19403C | 120 | 60 | Grey | On request | 3 m bars |

Plate
50 x 6 mm



Option of application - Plate

Part 159
Pag 410



Option of application - Guide

189 Guida laterale / Side guide / Seitenführung

Delivery: **Easy** **Standard** Fit on 40 x 8 mm

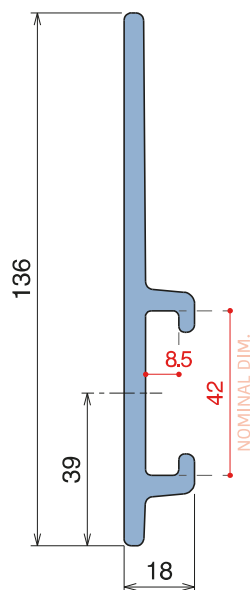
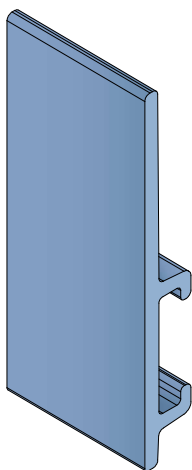

| Article-Nr. | Material | Availability | Supply |
|-------------|---------------|--------------|----------|
| 18912BC | BluLub | Stock item | 3 m bars |
| 18912BLC | Blue | On request | 3 m bars |
| 18916C | Grey | On request | 3 m bars |

Plate
40 x 8 mm



Option of application - Plate

Part 117
Pag 410



Option of application - M-Profile

Part 1055
Pag 410



Option of application - Guide

Guida laterale con salva etichetta Side guide with lable saver / Seitenführung mit Etikettenschutz

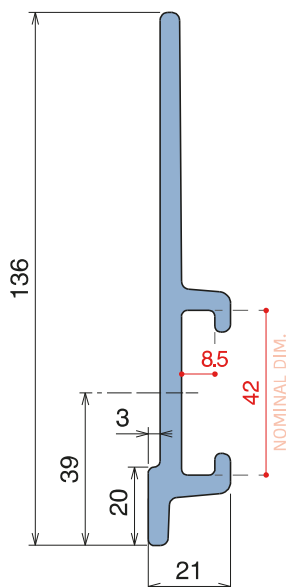
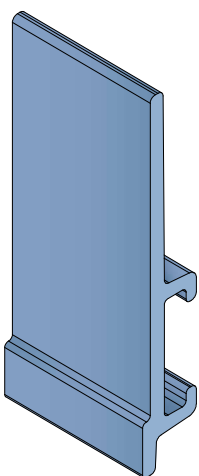

Easy Bendable

For the grooved version, just add "-S" to the related Article Nr.

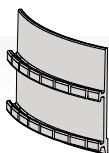

| Article-Nr. | Material | Availability | Supply |
|-------------|---------------|--------------|----------|
| 18910BC | BluLub | Stock item | 3 m bars |
| 18910BLC | Blue | On request | 3 m bars |
| 18914C | Grey | Stock item | 3 m bars |

Plate
40 x 8 mm



Option of application - Plate

Part 117
Pag 410



Option of application - M-Profile

Part 1055
Pag 410



Option of application - Guide

Guida laterale con salva etichetta
Side guide with lable saver / Seitenführung mit Etikettenschutz

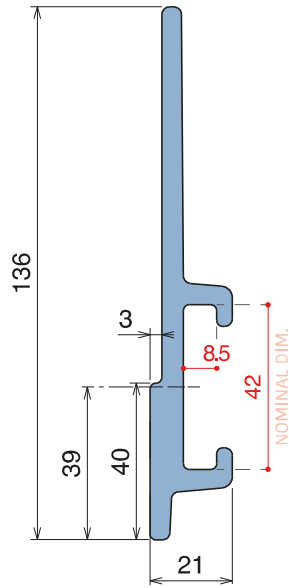
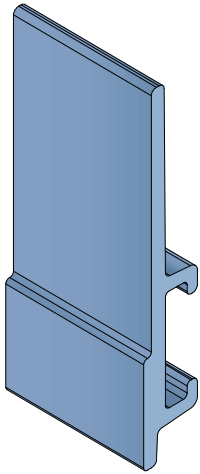

| Article-Nr. | Material | Availability | Supply |
|-------------|----------|--------------|----------|
| 18911BC | BluLub | Stock item | 3 m bars |
| 18911BLC | Blue | On request | 3 m bars |
| 18915C | Grey | On request | 3 m bars |

Plate
40 x 8 mm

Valid also for RS versions



Option of application - Plate

Part 117
Pag 410

Valid also for RS versions



Option of application - M-Profile

Part 1055
Pag 410

Valid also for RS versions



Option of application - Guide

NEW 1079

RS Guida laterale con salva etichetta / Side guide with lable saver / Seitenführung mit Etikettenschutz

Delivery: **Easy** **Standard** Fit on 40 x 8 mm

| Article-Nr. | Version | Material | Availability | Supply |
|-------------|---------|--------------|--------------|----------|
| 107900 | A | Black+BluLub | On request | 3 m bars |
| 107901 | B | Black+BluLub | On request | 3 m bars |

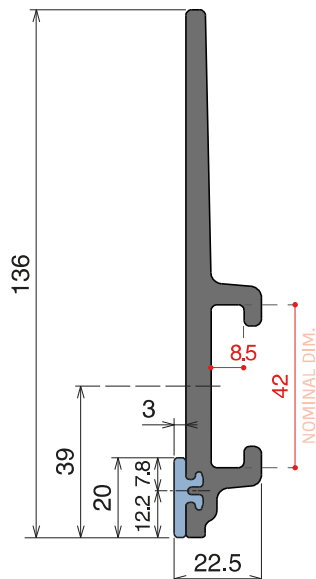
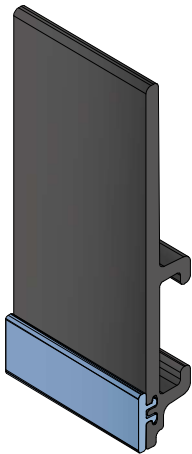

VERSION A - Label saver 2 cm

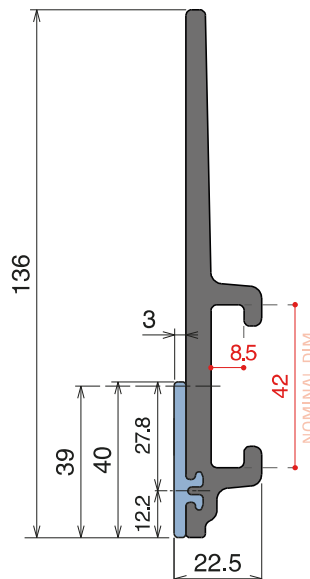

VERSION B - Label saver 4 cm

Base profile

| Art-Nr. | Supply |
|---------|----------|
| 18980 | 3 m bars |

Label saver 2 cm

| Art-Nr. | Supply |
|---------|------------|
| 18987 | 30 m coils |

Label saver 4 cm

| Art-Nr. | Supply |
|---------|------------|
| 18988 | 30 m coils |

Single components

Easy Bendable

For the grooved version, just add "S" to the related Article Nr.

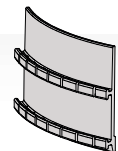

189 Guida laterale / Side guide / Seitenführung

Delivery: **Easy** **Standard** Fit on 50 x 6 mm

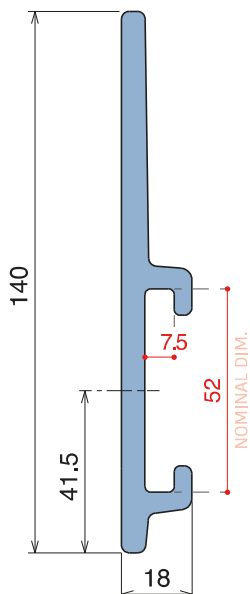
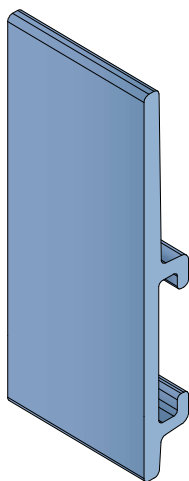

| Article-Nr. | Material | Availability | Supply |
|-------------|---------------|--------------|----------|
| 18902BC | BluLub | Stock item | 3 m bars |
| 18902BLC | Blue | On request | 3 m bars |
| 18906C | Grey | On request | 3 m bars |

Plate
50 x 6 mm



Option of application - Plate

Part 159
Pag 410



Option of application - Guide

Guida laterale con salva etichetta Side guide with lable saver / Seitenführung mit Etikettenschutz

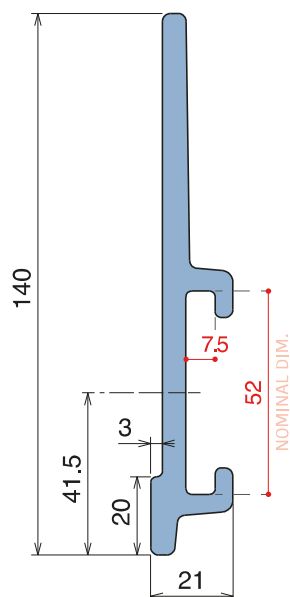
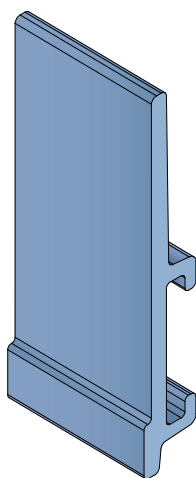

Easy Bendable

For the grooved version, just add "-S" to the related Article Nr.

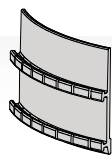

| Article-Nr. | Material | Availability | Supply |
|-------------|---------------|--------------|----------|
| 18900BC | BluLub | Stock item | 3 m bars |
| 18900BLC | Blue | On request | 3 m bars |
| 18904C | Grey | Stock item | 3 m bars |

Plate
50 x 6 mm



Option of application - Plate

Part 159
Pag 410



Option of application - Guide

Guida laterale con salva etichetta
Side guide with lable saver / Seitenführung mit Etikettenschutz

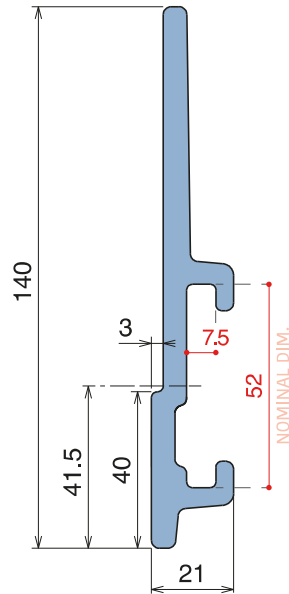
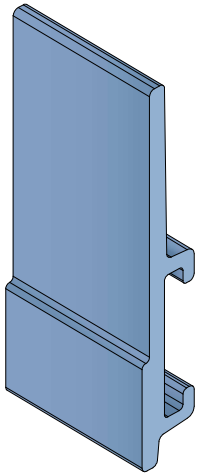

| Article-Nr. | Material | Availability | Supply |
|-----------------|---------------|--------------|----------|
| 18901BC | BluLub | Stock item | 3 m bars |
| 18901BLC | Blue | On request | 3 m bars |
| 18905C | Grey | On request | 3 m bars |

Plate
50 x 6 mm



Option of application - Plate

Part 159
Pag 410



Option of application - Guide

NEW 1096

Guida laterale con salva etichetta / Side guide with lable saver / Seitenführung mit Etikettenschutz

Delivery: **Easy** **Standard** Fit on 50 x 5 mm

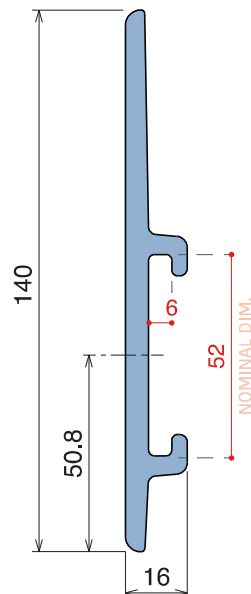
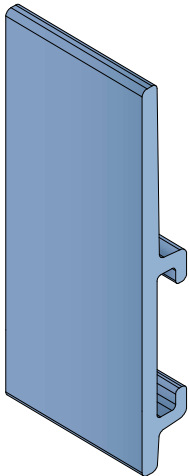

| Article-Nr. | Material | Availability | Supply |
|------------------|---------------|--------------|----------|
| 109600BC | BluLub | Stock item | 3 m bars |
| 109600BLC | Blue | On request | 3 m bars |
| 109605C | Grey | On request | 3 m bars |

Plate
50 x 5 mm



Option of application - Plate

Easy Bendable

For the grooved version, just add "-S" to the related Article Nr.

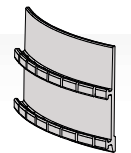

135

Guida laterale / Side guide / Seitenführung

Delivery: **Easy** **Standard** Fit on 60 x 6 mm

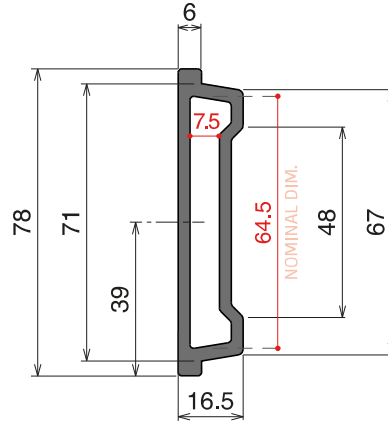
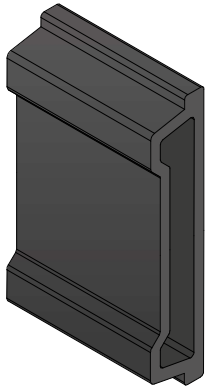

| Article-Nr. | Material | Availability | Supply |
|-------------|---------------|--------------|----------|
| 13501C | Black | Stock item | 3 m bars |
| 13501 | Black | Stock item | 6 m bars |
| 13502C | Blue RAL 5012 | Stock item | 3 m bars |
| 13502 | Blue RAL 5012 | Stock item | 6 m bars |

Plate
60 x 6 mm



Part 3310
pag 477

Option of application - Plate

136

Guida laterale / Side guide / Seitenführung

Delivery: **Easy** **Standard** Fit on 60 x 6 mm

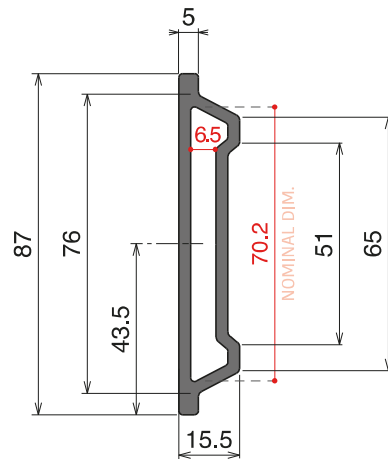
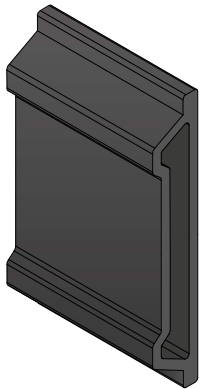

| Article-Nr. | Material | Availability | Supply |
|-------------|---------------|--------------|----------|
| 13601C | Black | Stock item | 3 m bars |
| 13601 | Black | On request | 6 m bars |
| 13602C | Blue RAL 5012 | Stock item | 3 m bars |
| 13602 | Blue RAL 5012 | Stock item | 6 m bars |

Plate
60 x 6 mm



Part 345
pag 477

Option of application - Plate

1057/1077

Guida laterale / Side guide / Seitenführung

Delivery: **Easy** **Standard** Fit on 50 x 6 mm

| Article-Nr. | Material | Availability | Supply |
|------------------|---------------|--------------|----------|
| 105720BLC | BluLub | Stock item | 3 m bars |
| 105721C | Black | On request | 3 m bars |
| 105725C | Blue | On request | 3 m bars |
| 105724C | Grey | On request | 3 m bars |

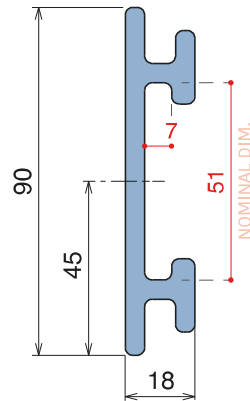
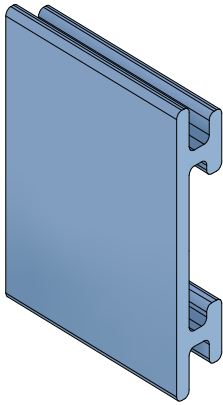

Plate
50 x 6 mm

Valid also for **RS** versions

Option of application - Plate

Part 159
Pag 410

Valid also for **RS** versions

Part 3311
pag 477

Option of application - Guide

Guida laterale con salva etichetta

Side guide with label saver / Seitenführung mit Etikettenschutz

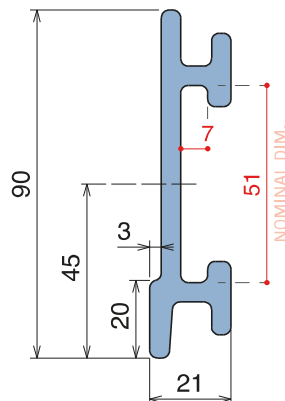
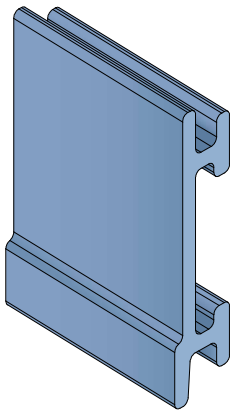

| Article-Nr. | Material | Availability | Supply |
|------------------|---------------|--------------|----------|
| 107720BLC | BluLub | Stock item | 3 m bars |
| 107721C | Black | On request | 3 m bars |
| 107725C | Blue | On request | 3 m bars |
| 107724C | Grey | On request | 3 m bars |

Plate
50 x 6 mm

Valid also for **RS** versions

Option of application - Plate

Part 159
Pag 410

Valid also for **RS** versions

Part 3311
pag 477

Option of application - Guide

Easy Bendable

For the grooved version, just add "-S" to the related Article Nr.

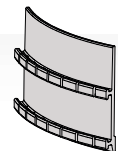

NEW 1077/1078

RS Guida laterale con salva etichetta / Side guide with lable saver / Seitenführung mit Etikettenschutz

| Delivery: | Easy | Standard | Fit on 50 x 6 mm | Article-Nr. | Version | Material | Availability | Supply |
|-----------|------|----------|------------------|---------------|---------|----------------------|--------------|----------|
| | | | | 107722 | A | Black+ BluLub | On request | 3 m bars |
| | | | | 107723 | B | Black+ BluLub | On request | 3 m bars |

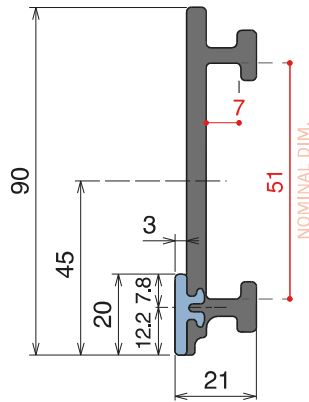
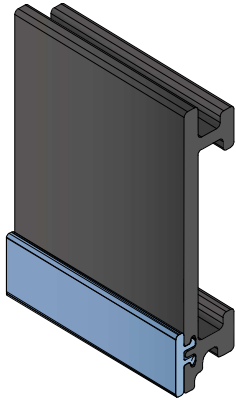

VERSION A - Label saver 2 cm

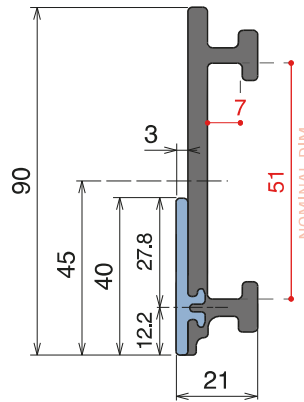

VERSION B - Label saver 4 cm

Base profile

| Art-Nr. | Supply |
|---------------|----------|
| 107790 | 3 m bars |

Label saver 2 cm

| Art-Nr. | Supply |
|--------------|------------|
| 18987 | 30 m coils |

Label saver 4 cm

| Art-Nr. | Supply |
|--------------|------------|
| 18988 | 30 m coils |

Single components

Guida laterale con salva etichetta Side guide with lable saver / Seitenführung mit Etikettenschutz

| Article-Nr. | Version | Material | Availability | Supply |
|---------------|---------|----------------------|--------------|----------|
| 107822 | A | Black+ BluLub | On request | 3 m bars |
| 107823 | B | Black+ BluLub | On request | 3 m bars |

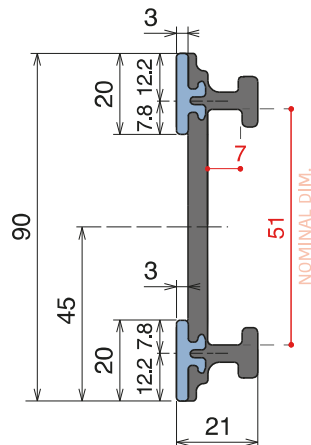
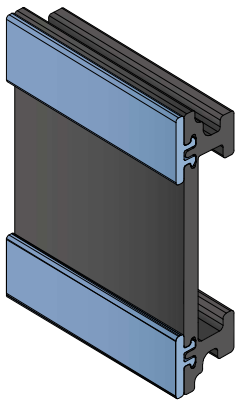

VERSION A - Label saver 2 cm

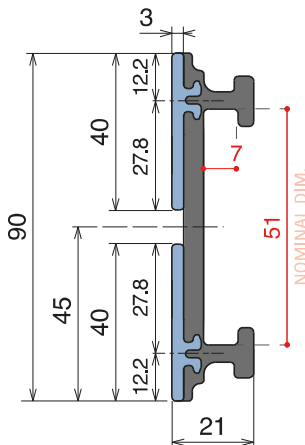

VERSION B - Label saver 4 cm

Base profile

| Art-Nr. | Supply |
|---------------|----------|
| 107890 | 3 m bars |

Label saver 2 cm

| Art-Nr. | Supply |
|--------------|------------|
| 18987 | 30 m coils |

Label saver 4 cm

| Art-Nr. | Supply |
|--------------|------------|
| 18988 | 30 m coils |

Label saver 2 cm and 4 cm can also be combined together to obtain different version.

Single components

Easy Bendable

For the grooved version, just add "S" to the related Article Nr.

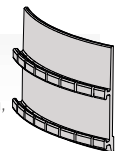

1057/1077

Guida laterale / Side guide / Seitenführung

Delivery: **Easy** **Standard** Fit on 60 x 6 mm

| Article-Nr. | Material | Availability | Supply |
|-------------|---------------|--------------|----------|
| 105700BC | BluLub | Stock item | 3 m bars |
| 105711C | Black | Stock item | 3 m bars |
| 105705C | Blue | On request | 3 m bars |
| 105704C | Grey | Stock item | 3 m bars |

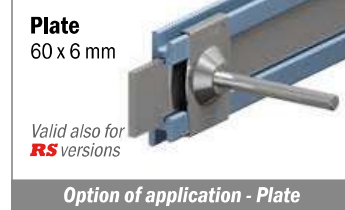
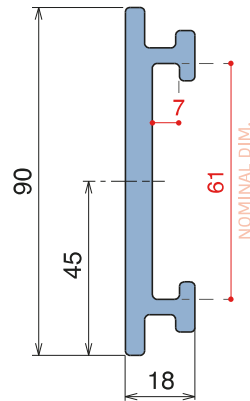
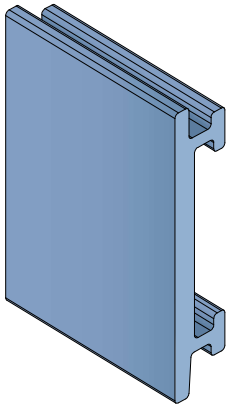

Guida laterale con salva etichetta

Side guide with label saver / Seitenführung mit Etikettenschutz

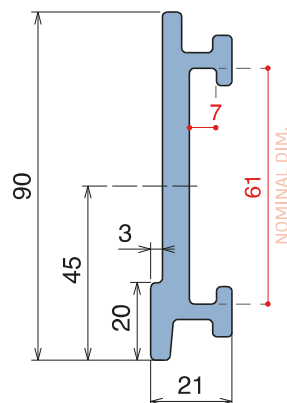
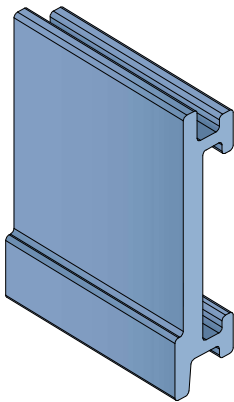

| Article-Nr. | Material | Availability | Supply |
|-------------|---------------|--------------|----------|
| 107700BC | BluLub | On request | 3 m bars |
| 107711C | Black | On request | 3 m bars |
| 107705C | Blue | On request | 3 m bars |
| 107704C | Grey | On request | 3 m bars |



Easy Bendable

For the grooved version, just add "-S" to the related Article Nr.

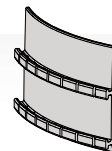

NEW 1077/1078

RS Guida laterale con salva etichetta / Side guide with lable saver / Seitenführung mit Etikettenschutz

| Delivery: | Easy | Standard | Fit on 60 x 6 mm | Article-Nr. | Version | Material | Availability | Supply |
|-----------|------|----------|------------------|---------------|---------|----------------------|--------------|----------|
| | | | | 107700 | A | Black+ BluLub | On request | 3 m bars |
| | | | | 107701 | B | Black+ BluLub | On request | 3 m bars |

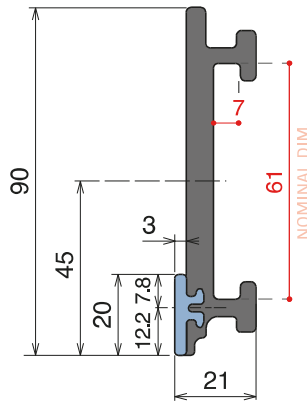
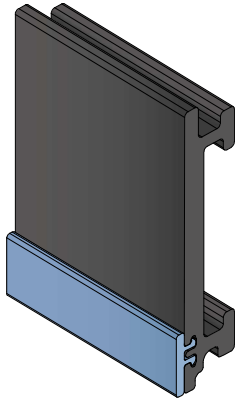

VERSION A - Label saver 2 cm

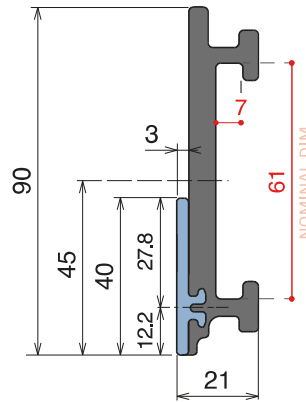

VERSION B - Label saver 4 cm

Base profile

| Art-Nr. | Supply |
|---------------|----------|
| 107791 | 3 m bars |

Label saver 2 cm

| Art-Nr. | Supply |
|--------------|------------|
| 18987 | 30 m coils |

Label saver 4 cm

| Art-Nr. | Supply |
|--------------|------------|
| 18988 | 30 m coils |

Single components

Guida laterale con salva etichetta
Side guide with lable saver / Seitenführung mit Etikettenschutz

| Article-Nr. | Version | Material | Availability | Supply |
|---------------|---------|----------------------|--------------|----------|
| 107800 | A | Black+ BluLub | On request | 3 m bars |
| 107801 | B | Black+ BluLub | On request | 3 m bars |

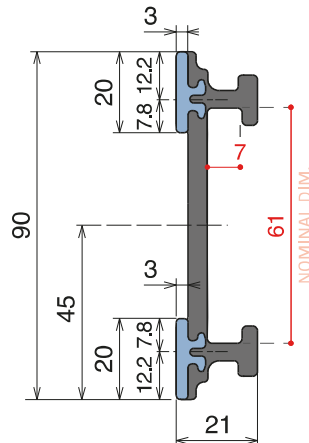
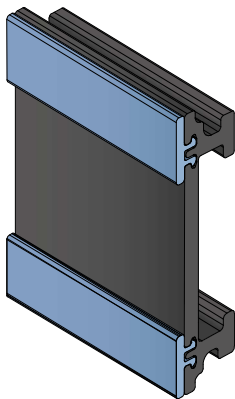

VERSION A - Label saver 2 cm

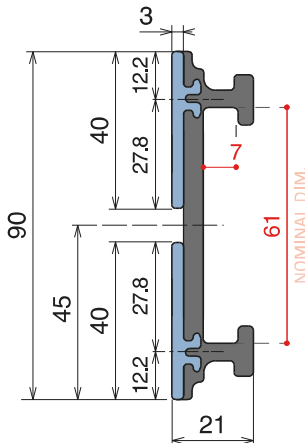

VERSION B - Label saver 4 cm

Base profile

| Art-Nr. | Supply |
|---------------|----------|
| 107891 | 3 m bars |

Label saver 2 cm

| Art-Nr. | Supply |
|--------------|------------|
| 18987 | 30 m coils |

Label saver 4 cm

| Art-Nr. | Supply |
|--------------|------------|
| 18988 | 30 m coils |

Label saver 2 cm and 4 cm
can also be combined together to obtain different version.

Single components

Easy Bendable

For the grooved version, just add "S" to the related Article Nr.

193/189

Guida laterale / Side guide / Seitenführung

Delivery: **Easy** **Standard** Fit on 60 x 5 mm

| Article-Nr. | Material | Availability | Supply |
|----------------|---------------|--------------|----------|
| 19330BC | BluLub | Stock item | 3 m bars |
| 19335C | Blue | On request | 3 m bars |
| 19334C | Grey | On request | 3 m bars |

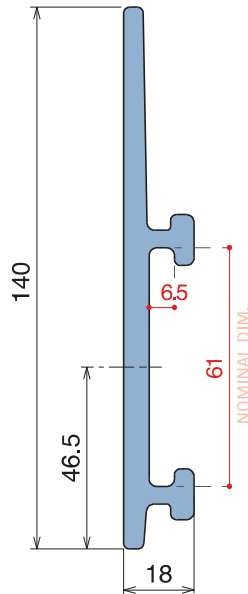
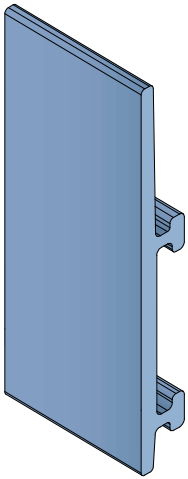

Guida laterale con salva etichetta

Side guide with lable saver / Seitenführung mit Etikettenschutz

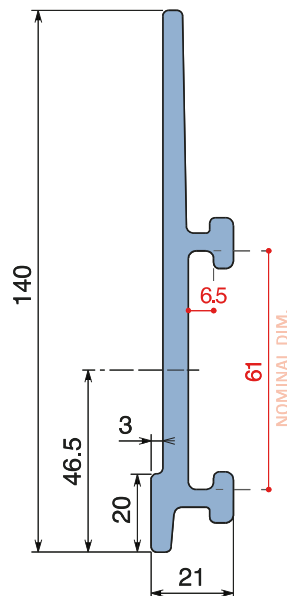
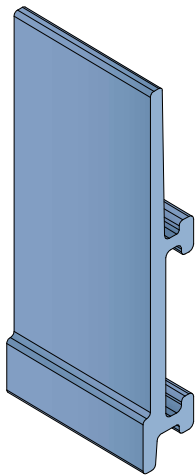

| Article-Nr. | Material | Availability | Supply |
|----------------|---------------|--------------|----------|
| 18980BC | BluLub | Stock item | 3 m bars |
| 18985C | Blue | On request | 3 m bars |
| 18984C | Grey | On request | 3 m bars |

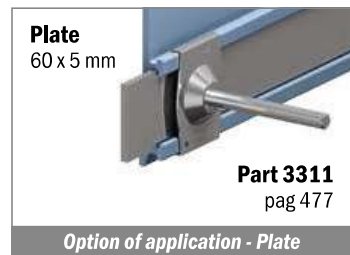

Easy Bendable

For the grooved version, just add "-S" to the related Article Nr.

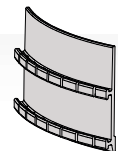

Guida laterale con salva etichetta

Side guide with label saver / Seitenführung mit Etikettenschutz

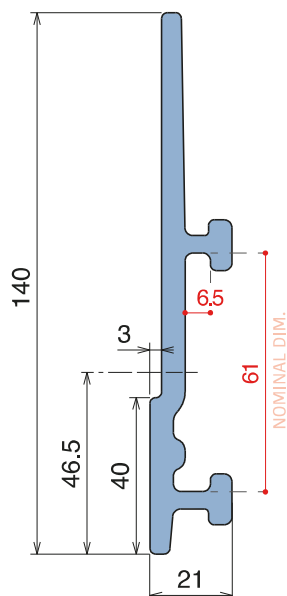
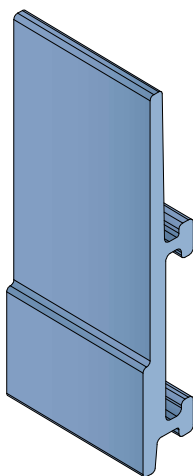

| Article-Nr. | Material | Availability | Supply |
|-------------|----------|--------------|----------|
| 18940BC | BluLub | Stock item | 3 m bars |
| 18945C | Blue | On request | 3 m bars |
| 18944C | Grey | Stock item | 3 m bars |

Plate
60 x 5 mm



Valid also for
RS versions

Part 3311
pag 477

Option of application - Plate

Part 1088
Pag 410



Valid also for
RS versions

Part 3311
pag 477

Option of application - Guide

Easy Bendable

For the grooved version, just add "-S" to the related Article Nr.

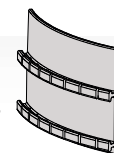

193 Guida laterale / Side guide / Seitenführung

Delivery: **Easy** **Standard** Fit on 60 x 6 mm

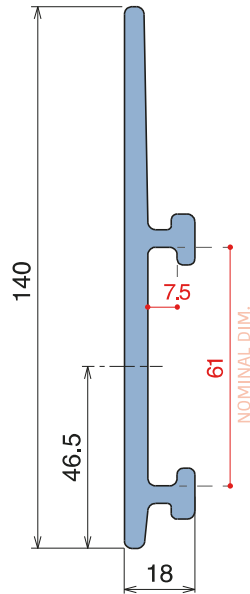
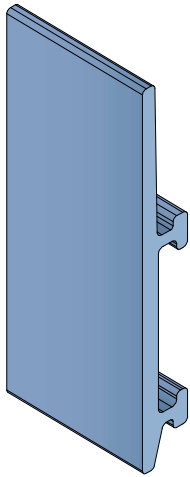

| Article-Nr. | Material | Availability | Supply |
|-------------|----------|--------------|----------|
| 19320BC | BluLub | Stock item | 3 m bars |
| 19325C | Blue | On request | 3 m bars |
| 19324C | Grey | Stock item | 3 m bars |

Plate
60 x 6 mm



Part 3311
pag 477

Option of application - Plate

Part 1089
Pag 410



Part 3311
pag 477

Option of application - Guide

189 Guida laterale con salva etichetta / Side guide with lable saver / Seitenführung mit Etikettenschutz

Delivery: **Easy** **Standard** Fit on 60 x 6 mm

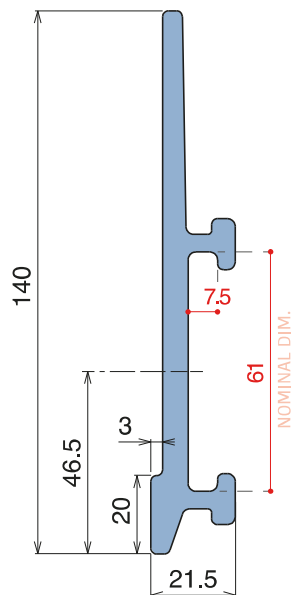
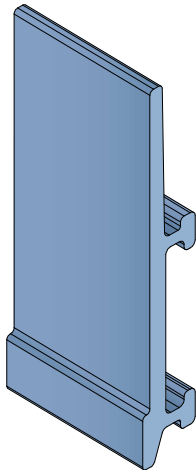

| Article-Nr. | Material | Availability | Supply |
|-------------|----------|--------------|----------|
| 18920BC | BluLub | Stock item | 3 m bars |
| 18925C | Blue | On request | 3 m bars |
| 18924C | Grey | Stock item | 3 m bars |

Plate
60 x 6 mm



Valid also for **RS** versions

Part 3311
pag 477

Option of application - Plate

Part 1089
Pag 410



Valid also for **RS** versions

Part 3311
pag 477

Option of application - Guide

Easy Bendable

For the grooved version, just add "-S" to the related Article Nr.

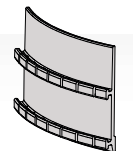

189-1075 RS

Guide estruse / Extruded profiles / Extrudiertes Profil

Guida laterale con salva etichetta

Side guide with lable saver / Seitenführung mit Etikettenschutz

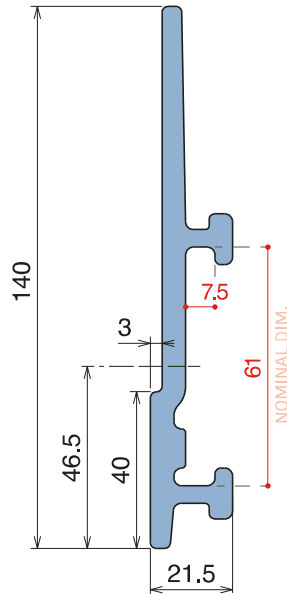
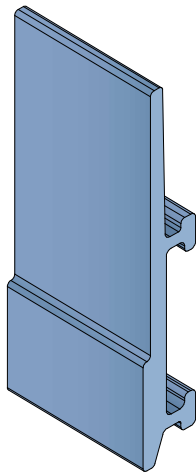

| Article-Nr. | Material | Availability | Supply |
|-------------|----------|--------------|----------|
| 18930BC | BluLub | Stock item | 3 m bars |
| 18935C | Blue | On request | 3 m bars |
| 18934C | Grey | Stock item | 3 m bars |

Plate
60 x 6 mm



Valid also for
RS versions

Part 3311
pag 477

Option of application - Plate

Part 1089
Pag 410



Valid also for
RS versions

Part 3311
pag 477

Option of application - Guide

NEW 1075

RS Guida laterale con salva etichetta / Side guide with lable saver / Seitenführung mit Etikettenschutz

Delivery: **Easy** **Standard** Fit on 60 x 6 mm

| Article-Nr. | Version | Material | Availability | Supply |
|-------------|---------|--------------|--------------|----------|
| 107500 | A | Black+BluLub | On request | 3 m bars |
| 107501 | B | Black+BluLub | On request | 3 m bars |

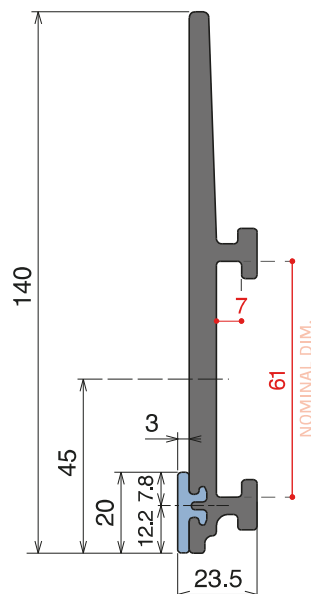
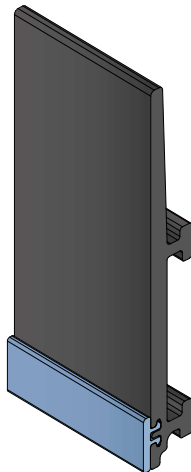

VERSION A - Label saver 2 cm

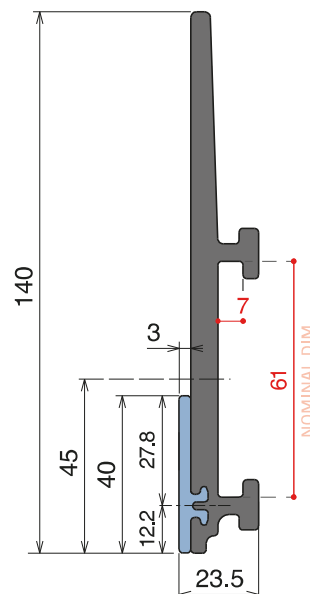

VERSION B - Label saver 4 cm

Base profile

| Art-Nr. | Supply |
|---------|----------|
| 18990 | 3 m bars |

Label saver 2 cm

| Art-Nr. | Supply |
|---------|------------|
| 18987 | 30 m coils |

Label saver 4 cm

| Art-Nr. | Supply |
|---------|------------|
| 18988 | 30 m coils |

Single components

Easy Bendable

For the grooved version, just add "S" to the related Article Nr.

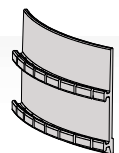

187 Guida laterale / Side guide / Seitenführung

Delivery: **Easy** **Standard** Fit on 60 x 6 mm

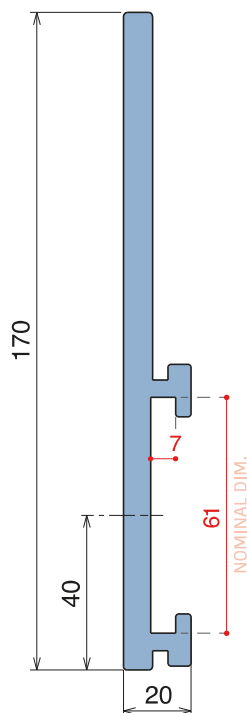
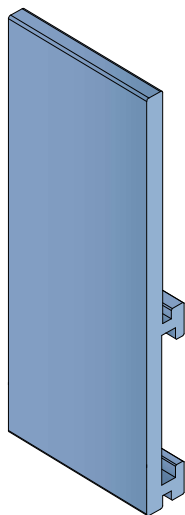

| Article-Nr. | Material | Availability | Supply |
|----------------|---------------|--------------|----------|
| 18710BC | <i>BluLub</i> | Stock item | 3 m bars |
| 18705C | Blue | On request | 3 m bars |
| 18714C | Grey | On request | 3 m bars |



Guida laterale con salva etichetta Side guide with label saver / Seitenführung mit Etikettenschutz

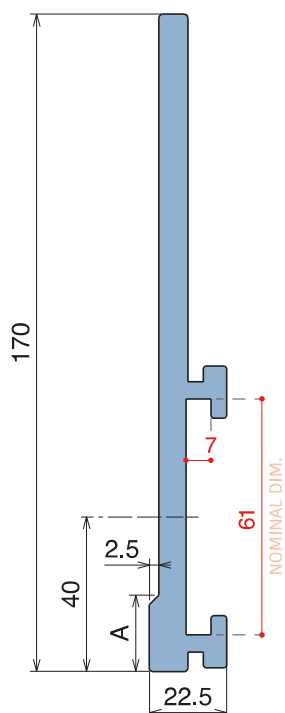
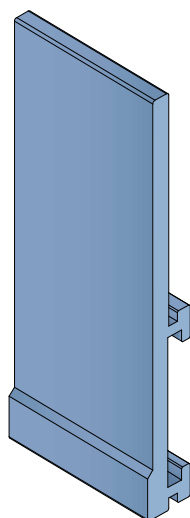

| Article-Nr. | A | Material | Availability | Supply |
|----------------|----|---------------|--------------|----------|
| 18720BC | 12 | <i>BluLub</i> | Stock item | 3 m bars |
| 18730BC | 20 | <i>BluLub</i> | Stock item | 3 m bars |
| 18740BC | 40 | <i>BluLub</i> | Stock item | 3 m bars |
| 18725C | 12 | Blue | On request | 3 m bars |
| 18735C | 20 | Blue | On request | 3 m bars |
| 18745C | 40 | Blue | On request | 3 m bars |
| 18724C | 12 | Grey | On request | 3 m bars |
| 18734C | 20 | Grey | On request | 3 m bars |
| 18744C | 40 | Grey | On request | 3 m bars |

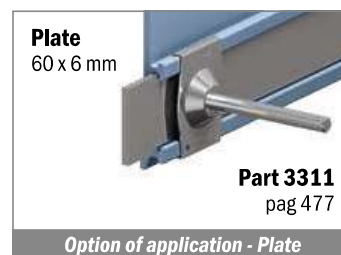

Easy Bendable

For the grooved version, just add "-S" to the related Article Nr.

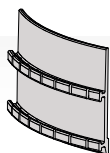

117 Profilo Omega / M-Profile / M-Profil

Delivery: **Easy** **Standard**

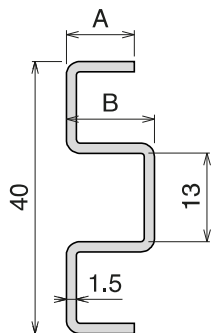
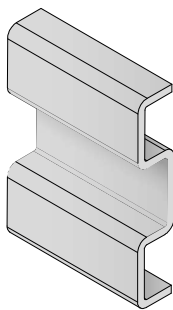

Used with part:
137 - 183 - 189 - 1079

| Article-Nr. | A | B | Availability | Supply |
|---------------|----|----|--------------|----------|
| 11703C | 6 | 10 | Stock item | 3 m bars |
| 11703 | 6 | 10 | On request | 6 m bars |
| 11701C | 8 | 8 | Stock item | 3 m bars |
| 11701 | 8 | 8 | Stock item | 6 m bars |
| 11702C | 10 | 10 | Stock item | 3 m bars |
| 11702 | 10 | 10 | On request | 6 m bars |

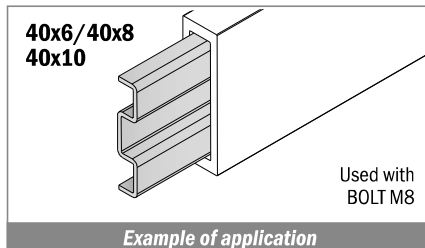

1055 Profilo in Acciaio inox / Stainless steel Profile / Edelstahlprofil

Delivery: **Easy** **Standard**

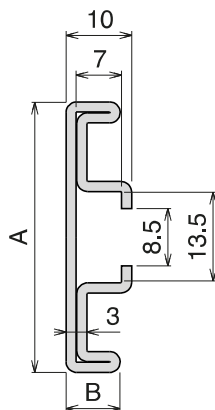
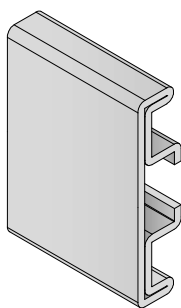

Used with part:
137 - 183 - 189 - 1079

| Article-Nr. | A | B | Availability | Supply | Profile cover |
|----------------|----|---|--------------|----------|---------------|
| 105501C | 40 | 8 | Stock item | 3 m bars | 301409 |
| 105501 | 40 | 8 | On request | 6 m bars | 301409 |
| 105503C | 50 | 6 | Stock item | 3 m bars | 301410 |
| 105503 | 50 | 6 | On request | 6 m bars | 301410 |

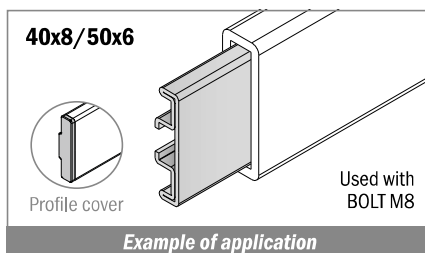

159-1088-1089 Profilo in Alluminio / Aluminum Profile / Aluminium Profil

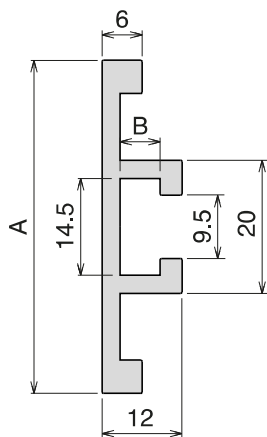
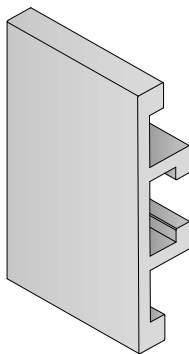

Used with Part:
158 - 187 - 189 - 193
1057 - 1075 - 1077 - 1078

| Article-Nr. | A | B | Availability | Supply | Profile cover |
|----------------|----|---|--------------|----------|---------------|
| 15901C | 50 | 6 | Stock item | 3 m bars | 301411 |
| 15901 | 50 | 6 | On request | 6 m bars | 301411 |
| 108801C | 60 | 5 | Stock item | 3 m bars | 301412 |
| 108801 | 60 | 5 | On request | 6 m bars | 301412 |
| 108901C | 60 | 6 | Stock item | 3 m bars | 301413 |
| 108901 | 60 | 6 | On request | 6 m bars | 301413 |

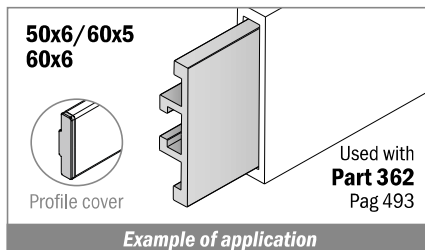

Materiale / Material / Materialien:
 Polietilene HMW-PE / Polyethylene HMW-PE / Polyethylen HMW-PE
 Rulli: resina acetica o gomma SEBS / Rollers: Acetal Resin or SEBS
 rubber / Röllchen: Azetal oder SEBS gummi

335 Guide a rulli laterale Roller guides / Röllchenführung

PATENTED

Max fixing load M8 screw: 15 N/m | Minimum internal and external radius: R305



TYPE A

| Part | Article-Nr. | Type |
|------|-------------|------|
| 335 | 33502 | A |



TYPE B

| Part | Article-Nr. | Type |
|------|-------------|------|
| 335 | 33504 | B |



TYPE B1

| Part | Article-Nr. | Type |
|------|-------------|------|
| 335 | 33506 | B1 |

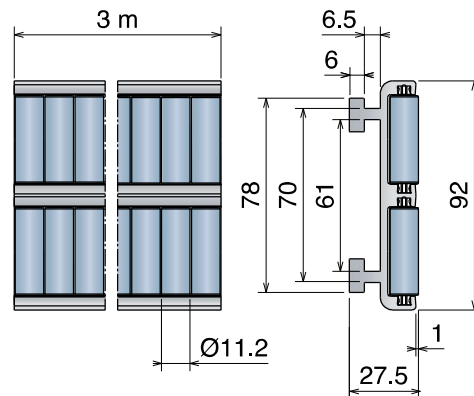
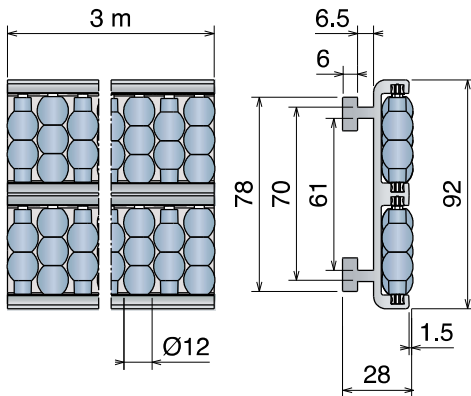

TYPE B1
 Soft roller
 SEBS rubber

Advantages:

- ▶ Noise reduction
- ▶ Improved product stability

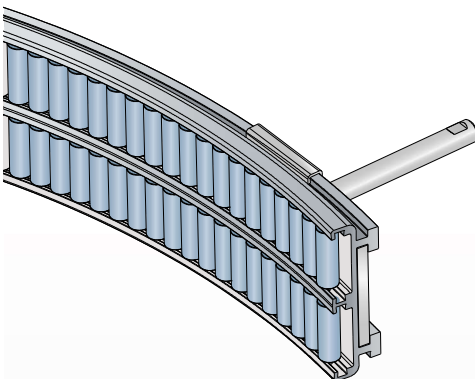

Available rollers
 for bending
 machine

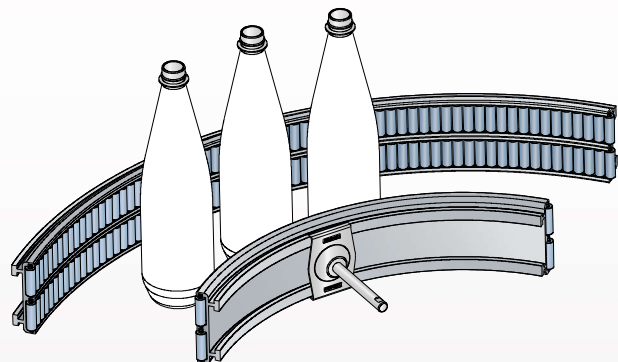
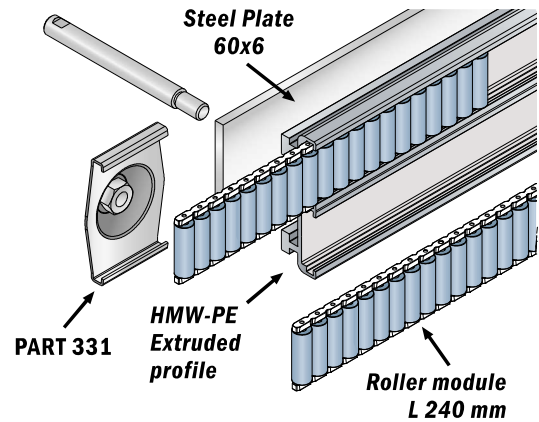

358 Guide a rulli laterale
 Roller guides / Röllchenführung

Delivery: **Easy** **Standard** Max fixing load M8 screw: 15 N/m

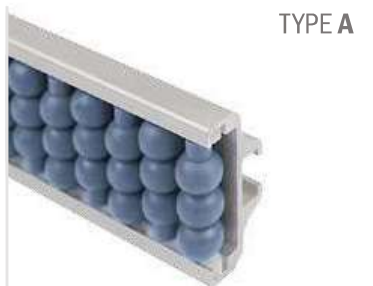

TYPE A

| Part | Article-Nr. | Type |
|------|-------------|------|
| 358 | 35802 | A |

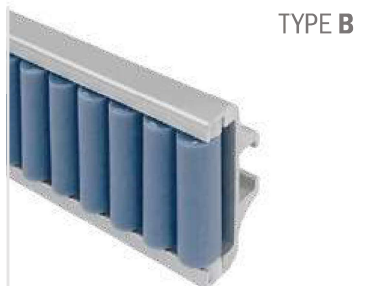

TYPE B

| Part | Article-Nr. | Type |
|------|-------------|------|
| 358 | 35804 | B |

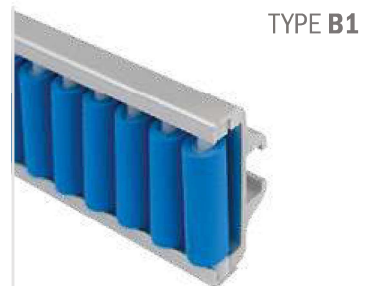

TYPE B1

| Part | Article-Nr. | Type |
|------|-------------|------|
| 358 | 35806 | B1 |

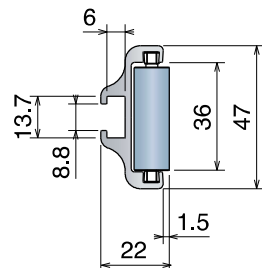
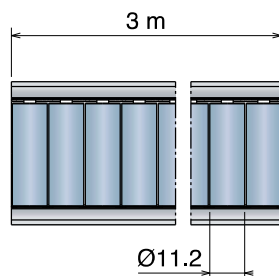
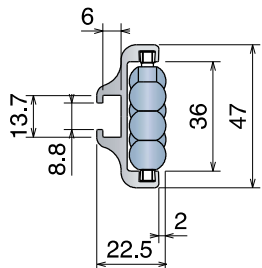
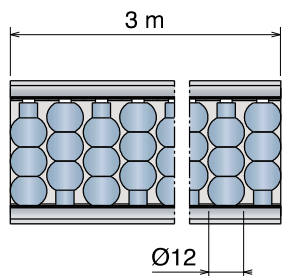

TYPE B1
 Soft roller
 SEBS rubber

Roller
 Pag 425



Fixing screw:
 M8 hex. head
 or **PART 362**
 Pag 493



Puntale / Shoe / Einlaufschuh



| Part | Article-Nr. | Type |
|------|-------------|--------------------------|
| 364 | 36401 | fresato/machined/gefräst |

Discover more options:
 Pag 489/490

Materiale / Material / Materialien:

Guida: alluminio anodizzato / Guide: anodized aluminum / Führung: eloxiertem Aluminium
 Rulli: resina acetica o gomma SEBS / Rollers: Acetal Resin or SEBS rubber / Röllchen: Azetal oder SEBS gummi
 Vite: Acciaio inox / Screw: Stainless steel / Schrauben: Edelstahl

359 Guide a rulli laterale Roller guides / Röllchenführung

Delivery: **Easy** **Standard** Max fixing load M8 screw: 15 N/m



TYPE A

| Part | Article-Nr. | Type |
|------|-------------|------|
| 359 | 35902 | A |



TYPE B

| Part | Article-Nr. | Type |
|------|-------------|------|
| 359 | 35904 | B |

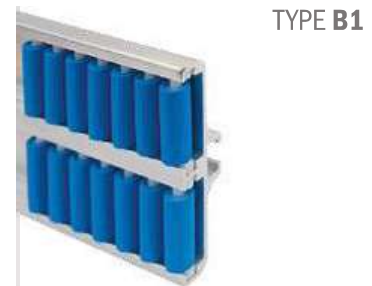

TYPE B1

| Part | Article-Nr. | Type |
|------|-------------|------|
| 359 | 35906 | B1 |

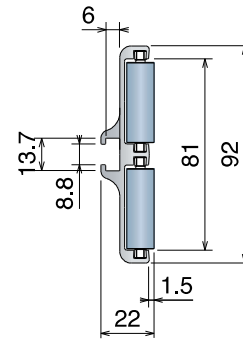
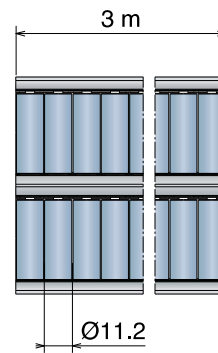
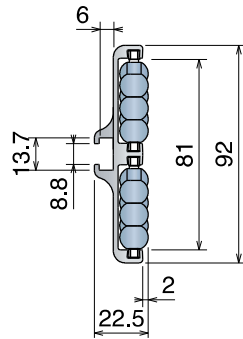
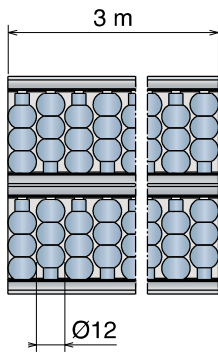

TYPE B1
 Soft roller
 SEBS rubber

Roller
 Pag 425



Fixing screw:
 M8 hex.head
 or **PART 362**
 Pag 493



Puntale / Shoe / Einlaufschuh



| Part | Article-Nr. | Type |
|------|-------------|--------------------------|
| 365 | 36501 | fresato/machined/gefräst |

Discover more options:
 Pag 489/490

360

Guide a rulli intermedia
 Roller guides / Röllchenführung

Delivery: **Easy** **Standard** Max fixing load M8 screw: 15 N/m

TYPE A

| Part | Article-Nr. | Type |
|------|-------------|------|
| 360 | 36002 | A |

TYPE B

| Part | Article-Nr. | Type |
|------|-------------|------|
| 360 | 36004 | B |

TYPE B1

| Part | Article-Nr. | Type |
|------|-------------|------|
| 360 | 36006 | B1 |

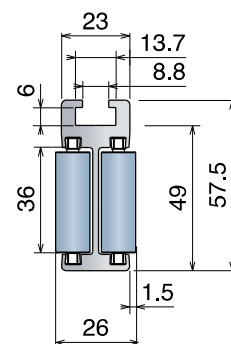
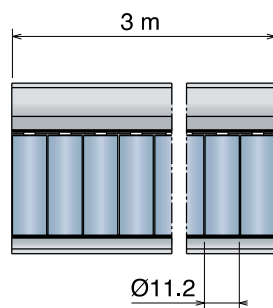
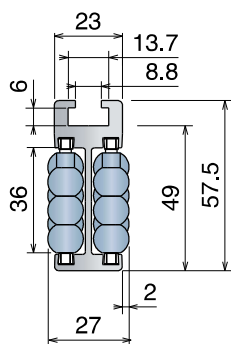
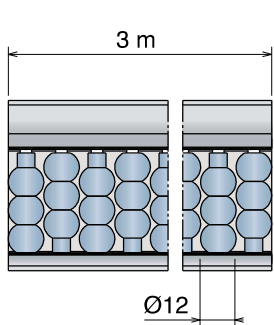

TYPE B1
 Soft roller
 SEBS rubber

Roller
 Pag 425



Fixing screw:
 M8 hex. head
 or **PART 362**
 Pag 493



Puntale / Shoe / Einlaufschuh



| Part | Article-Nr. | Type |
|------|-------------|--------------------------|
| 366 | 36601 | fresato/machined/gefräst |

Discover more options:
 Pag 489/490

Materiale / Material / Materialien:

Guida: alluminio anodizzato / Guide: anodized aluminum / Führung: eloxiertem Aluminium
 Rulli: resina acetica o gomma SEBS / Rollers: Acetal Resin or SEBS rubber / Röllchen: Azetal oder SEBS gummi

360 Guide a rulli intermedia Roller guides / Röllchenführung

REINFORCED VERSION

Max fixing load M8 screw: 15 N/m



TYPE A

| Part | Article-Nr. | Type |
|------|-------------|------|
| 360 | 36012 | A |



TYPE B

| Part | Article-Nr. | Type |
|------|-------------|------|
| 360 | 36014 | B |



TYPE B1

| Part | Article-Nr. | Type |
|------|-------------|------|
| 360 | 36016 | B1 |

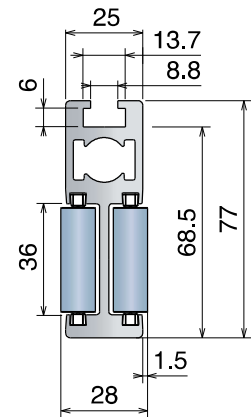
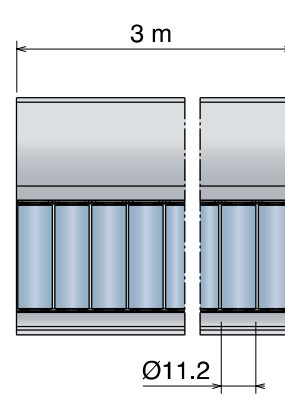
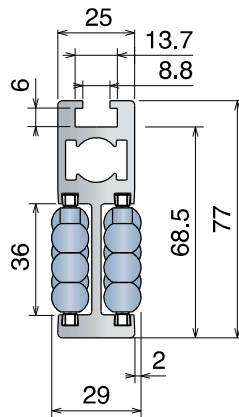
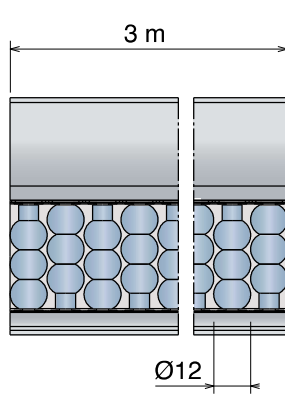

TYPE B1
 Soft roller
 SEBS rubber

Roller
 Pag 425



Fixing screw:
 M8 hex.head
 or **PART 362**
 Pag 493



Puntale / Shoe / Einlaufschuh



| Part | Article-Nr. | Type |
|------|-------------|--------------------------|
| 366 | 36601 | fresato/machined/gefräst |

Discover more options: Pag 489/490

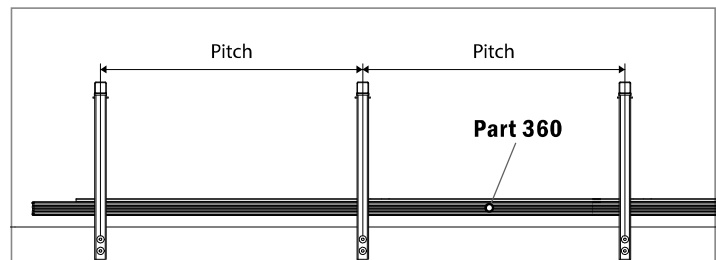

Part 360 Reinforced version is a reliable roller guides solution, the new robust design permits less support elements and allows higher pitches.

Example of application

361

Guide a rulli intermedia
 Roller guides / Röllchenführung

Delivery: **Easy** **Standard** Max fixing load M8 screw: 15 N/m

TYPE A



| Part | Article-Nr. | Type |
|------|-------------|------|
| 361 | 36102 | A |

TYPE B



| Part | Article-Nr. | Type |
|------|-------------|------|
| 361 | 36104 | B |

TYPE B1



| Part | Article-Nr. | Type |
|------|-------------|------|
| 361 | 36106 | B1 |

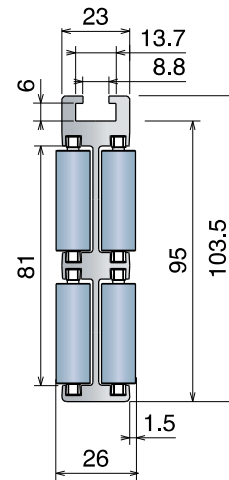
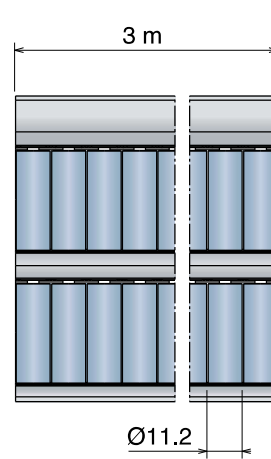
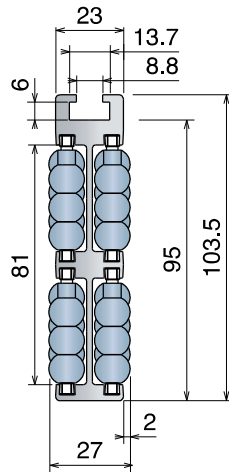
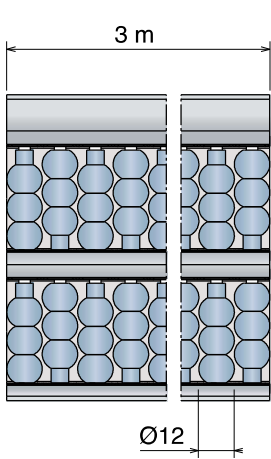

TYPE B1
 Soft roller
 SEBS rubber

Roller
 Pag 425



Fixing screw:
 M8 hex. head
 or **PART 362**
 Pag 493



Puntale / Shoe / Einlaufschuh



| Part | Article-Nr. | Type |
|------|-------------|--------------------------|
| 367 | 36701 | fresato/machined/gefräst |

Discover more options:
 Pag 489/490

Materiale / Material / Materialien:

Guida: alluminio anodizzato / Guide: anodized aluminum / Führung: eloxiertem Aluminium
 Rulli: resina acetica o gomma SEBS / Rollers: Acetal Resin or SEBS rubber / Röllchen: Azetal oder SEBS gummi

361 Guide a rulli intermedia Roller guides / Röllchenführung

REINFORCED VERSION

Delivery: **Easy** **Standard** Max fixing load M8 screw: 15 N/m



TYPE A

| Part | Article-Nr. | Type |
|------|-------------|------|
| 361 | 36112 | A |



TYPE B

| Part | Article-Nr. | Type |
|------|-------------|------|
| 361 | 36114 | B |

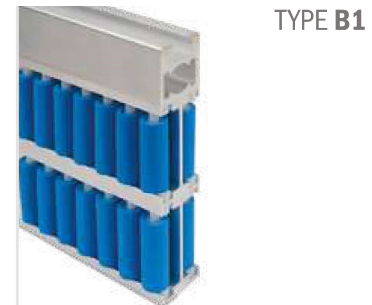

TYPE B1

| Part | Article-Nr. | Type |
|------|-------------|------|
| 361 | 36116 | B1 |

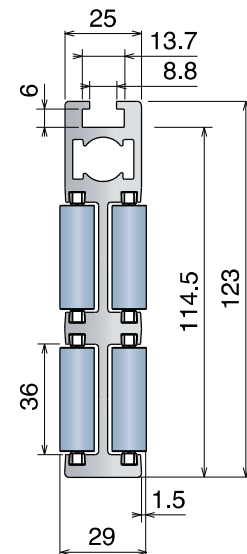
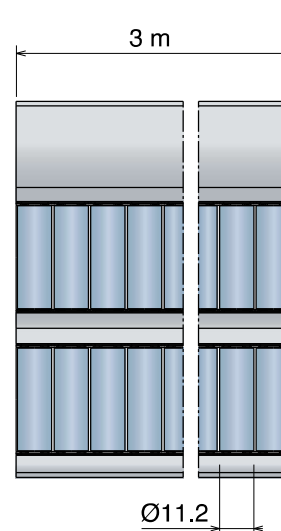
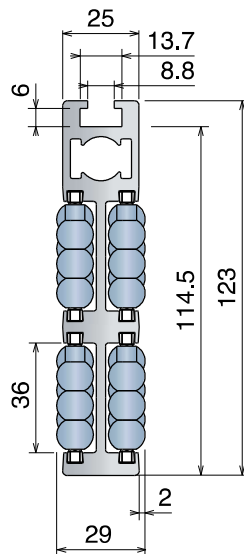
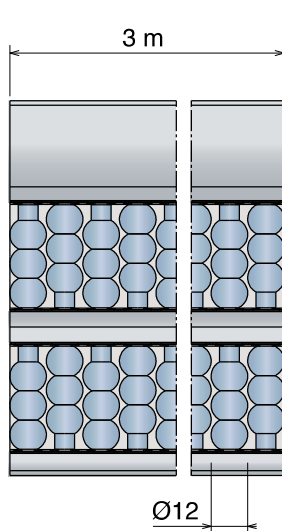

TYPE B1
 Soft roller
 SEBS rubber

Roller
 Pag 425



Fixing screw:
 M8 hex.head
 or **PART 362**
 Pag 493



Puntale / Shoe / Einlaufschuh



| Part | Article-Nr. | Type |
|------|-------------|--------------------------|
| 367 | 36701 | fresato/machined/gefräst |

Discover more options: Pag 489/490

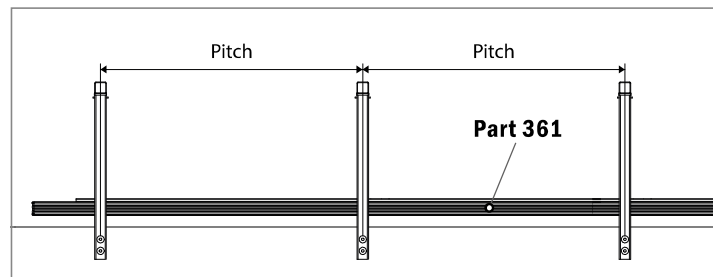

Part 361 Reinforced version is a reliable roller guides solution, the new robust design allows less support elements and wider pitches.

Example of application

Materiale / Material / Materialien:

Rulli: Resina acetatica / Rollers: Acetal Resin / Röllchen: Azetal
 Grano: Acciaio inox/Grub Screws: Stainless steel/Gewindestift: Edelstahl
 Dadi: ottone nichelato/Nuts: nickel plated brass/Mutter: Messing vernickelt

364 Puntale
 Shoe / Einlaufschuh

Delivery: **Easy** **Standard** Part 364 it is designed to allow the possibility to shorten it, if necessary.

| Part | Article-Nr. | Grub screw |
|------|-------------|------------|
| 364 | 36411 | M6 |

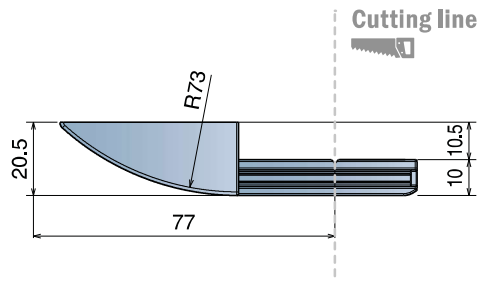
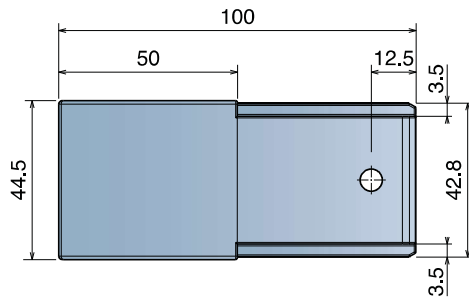
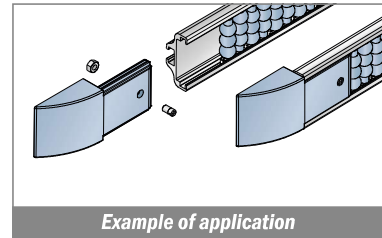

365 Puntale
 Shoe / Einlaufschuh

Delivery: **Easy** **Standard** Part 365 it is designed to allow the possibility to shorten it, if necessary.

| Part | Article-Nr. | Grub screw |
|------|-------------|------------|
| 365 | 36511 | M6 |

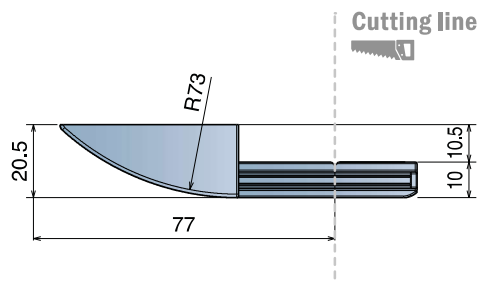
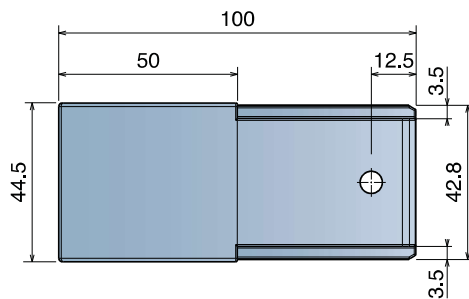
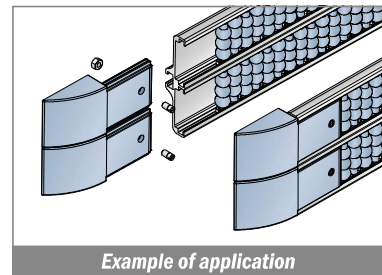

366-367

Componenti / Conveyor components / Komponenten

Materiale / Material / Materialien:

Rulli: Resina acetica / Rollers: Acetal Resin / Röllchen: Azetal
 Grano: Acciaio inox / Grub Screws: Stainless steel / Gewindestift: Edelstahl
 Dadi: ottone nichelato / Nuts: nickel plated brass / Mutter: Messing vernickelt

366 Puntale Shoe / Einlaufschuh

Delivery: **Easy** **Standard** Part 366 it is designed to allow the possibility to shorten it, if necessary.

| Part | Article-Nr. | Grub screw |
|------|-------------|------------|
| 366 | 36611 | M6 |

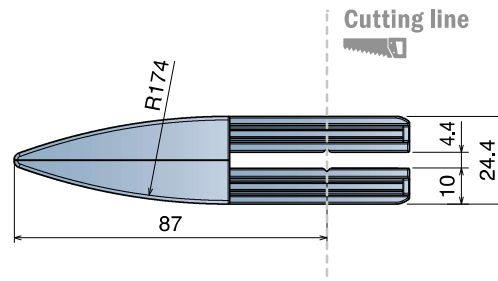
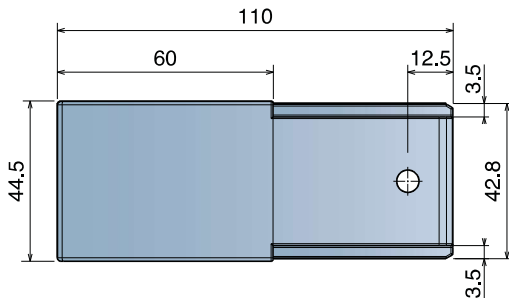
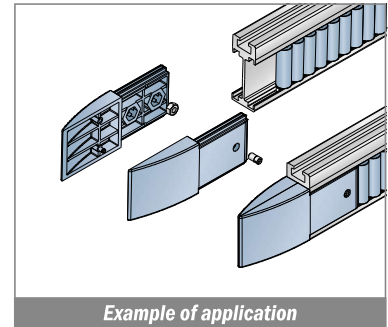

367 Puntale Shoe / Einlaufschuh

Delivery: **Easy** **Standard** Part 367 it is designed to allow the possibility to shorten it, if necessary.

| Part | Article-Nr. | Grub screw |
|------|-------------|------------|
| 367 | 36711 | M6 |

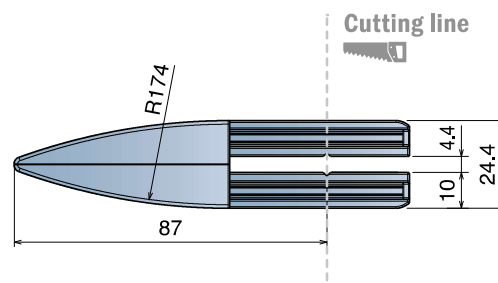
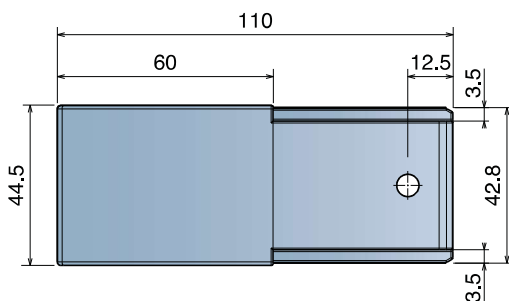
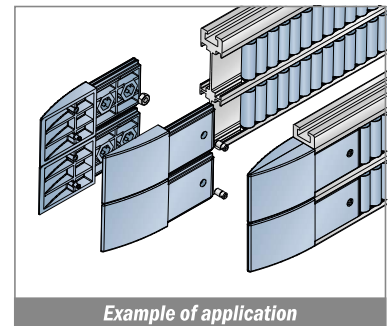

366 Puntale centrale a rulli Central roller shoe / Einlaufschuh

PATENTED



| Part | Article-Nr. | Type |
|------|-------------|-------------------------|
| 366 | 36621 | A - Acetal resin roller |
| 366 | 36622 | B - Acetal resin roller |
| 366 | 36623 | B1 - Soft roller SEBS |

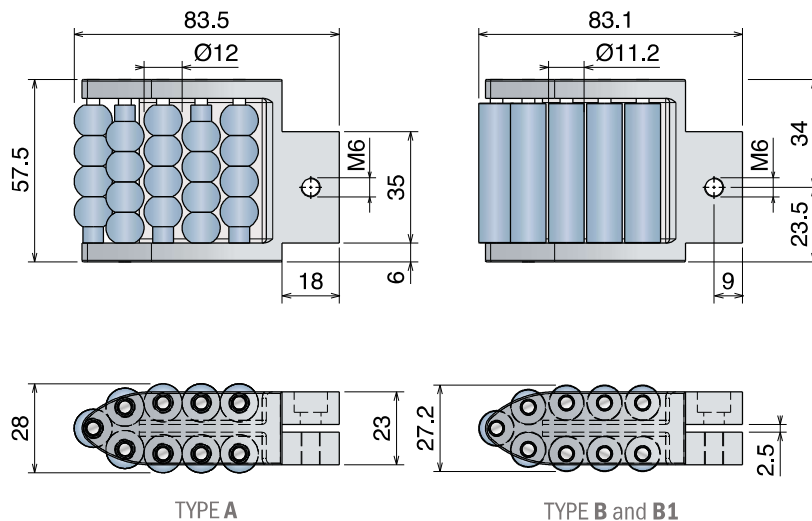

367 Puntale centrale a rulli Central roller shoe / Einlaufschuh

PATENTED



| Part | Article-Nr. | Type |
|------|-------------|-------------------------|
| 367 | 36721 | A - Acetal resin roller |
| 367 | 36722 | B - Acetal resin roller |
| 367 | 36723 | B1 - Soft roller SEBS |

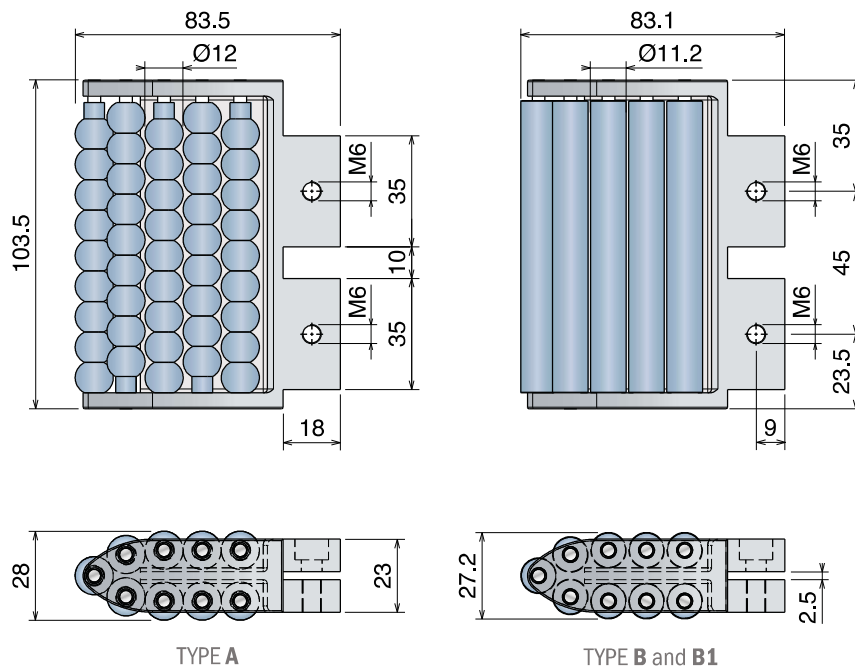

364 Puntale laterale a rulli Side roller shoe / Einlaufschuh

PATENTED



TYPE B1
Soft roller
SEBS rubber

| Part | Article-Nr. | Type |
|------|-------------|-------------------------|
| 364 | 36421 | A - Acetal resin roller |
| 364 | 36422 | B - Acetal resin roller |
| 364 | 36423 | B1 - Soft roller SEBS |

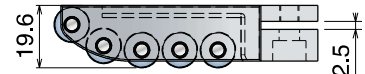
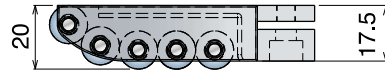
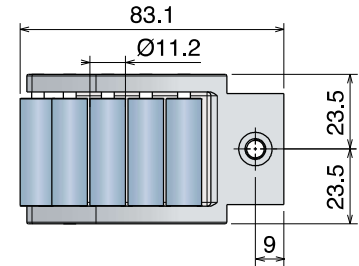
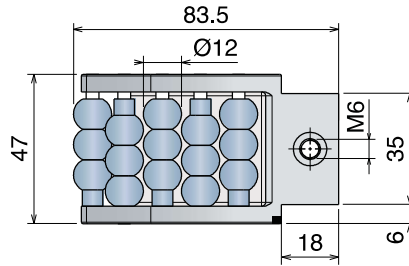

TYPE A

TYPE B and B1

365 Puntale laterale a rulli Side roller shoe / Einlaufschuh

PATENTED



| Part | Article-Nr. | Type |
|------|-------------|-------------------------|
| 365 | 36521 | A - Acetal resin roller |
| 365 | 36522 | B - Acetal resin roller |
| 365 | 36523 | B1 - Soft roller SEBS |

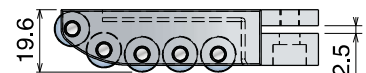
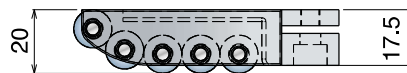
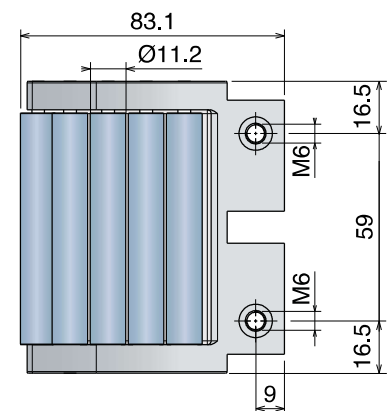
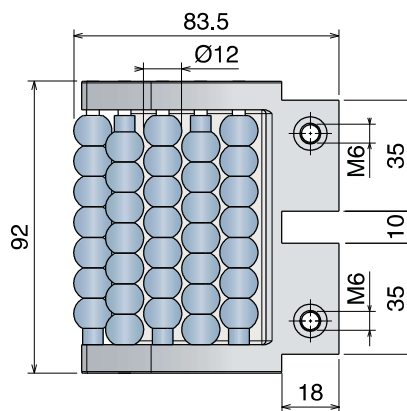

TYPE A

TYPE B and B1

395 Guida laterale in PE PE side guides / Seitenführung in PE

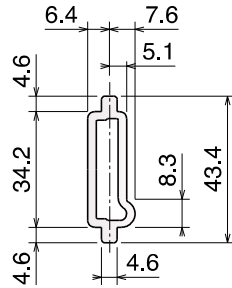

| Part | Article-Nr. | L |
|------|-------------|-----|
| 395 | 39501 | 3 m |



Example of application

362 Vite a "T" T-bolt / T-Schraube

Delivery: **Easy** **Standard** Used with Part 154/155/159/164/165/358/359/360/361/1055/1088/1089

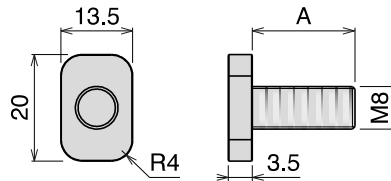

| Part | Article-Nr. | A |
|------|-------------|----|
| 362 | 36201 | 16 |
| 362 | 36202 | 19 |
| 362 | 36203 | 25 |

333 Elemento di giunzione Connecting elements / Verbindungselement

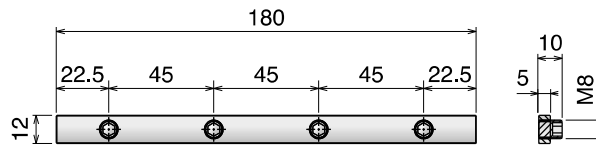

| Part | Article-Nr. |
|------|-------------|
| 333 | 33301 |

NEW 358/359/360/361 Guide in alluminio Aluminum guides / Aluminiumführung

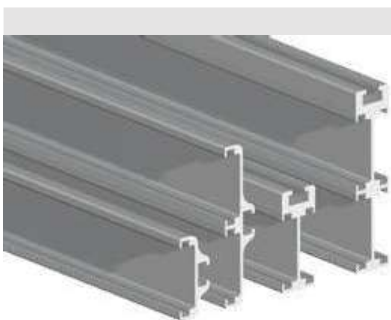

| Part | Article-Nr. | Version | Min. radius | Supply | Profile cover |
|------|-------------|----------------|-------------|--------|---------------|
| 358 | 35800 | Single-lateral | 250 | 3 m | 301405 |
| 359 | 35900 | Double-lateral | 500 | 3 m | 301406 |
| 360 | 36000 | Single-central | 500 | 3 m | 301407 |
| 361 | 36100 | Double-central | 750 | 3 m | 301408 |

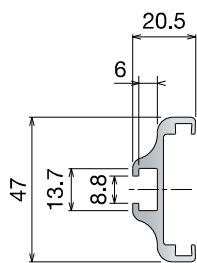
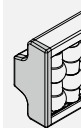

35800

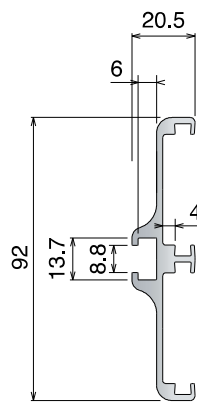

35900

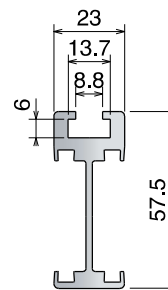

36000

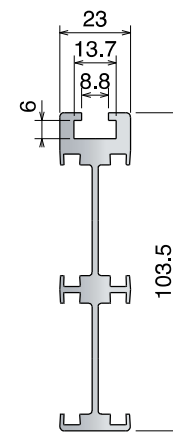

36100

353 Guide a rulli di accumulo Accumulation roller guides / Stauröllchenführung

Delivery: **Easy** Standard



| Part | Article-Nr. | A | Pin | Pin Ø |
|------|-------------|-----|-----|-------|
| 353 | 35301 | 1 m | PA | 6 mm |
| 353 | 35302 | 2 m | PA | 6 mm |
| 353 | 35303 | 3 m | PA | 6 mm |

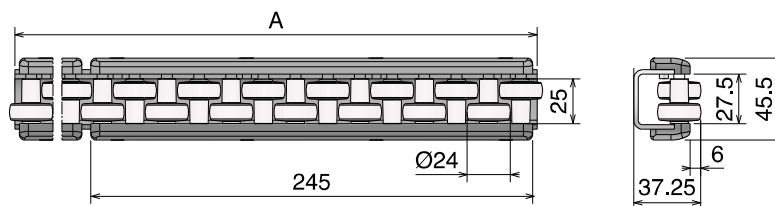

354 Guide a rulli di accumulo Accumulation roller guides / Stauröllchenführung

Delivery: **Easy** Standard



| Part | Article-Nr. | A | Pin | Pin Ø |
|------|-------------|-----|-----|-------|
| 354 | 35401 | 1 m | PA | 6 mm |
| 354 | 35402 | 2 m | PA | 6 mm |
| 354 | 35403 | 3 m | PA | 6 mm |

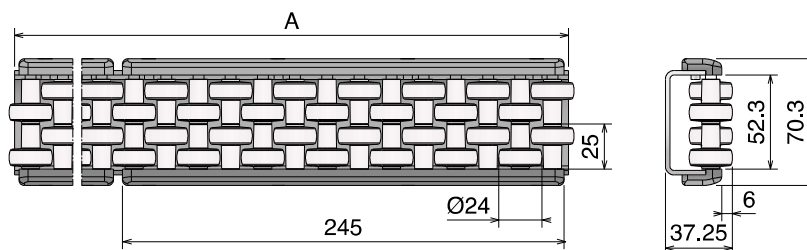

355 Guide a rulli di accumulo Accumulation roller guides / Stauröllchenführung

Delivery: **Easy** Standard



| Part | Article-Nr. | A | Pin | Pin Ø |
|------|-------------|-----|-----|-------|
| 355 | 35501 | 1 m | SS | 6 mm |
| 355 | 35502 | 2 m | SS | 6 mm |
| 355 | 35503 | 3 m | SS | 6 mm |

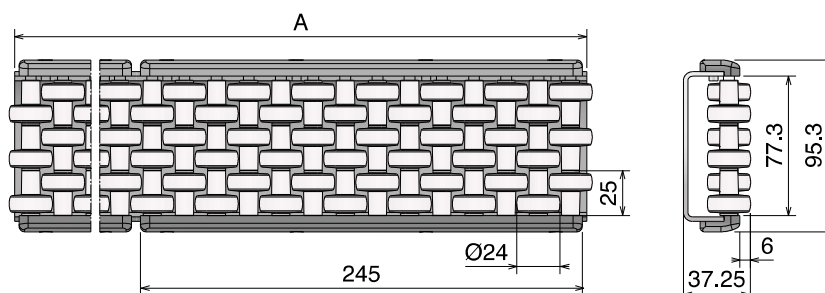

Material: Resina acetica / Acetal Resin / Azetal or **BluLub**.
 Polyethylene UHMW-PE with reduced coefficient of friction and higher wear resistance.
 BluLub complies with the code of Federal Regulations of FDA. Linear expansion coefficient:
 $1.1 \times 10^{-4} \text{ } ^\circ\text{F}^{-1}$ ($2 \times 10^{-4} \text{ } ^\circ\text{C}^{-1}$) Operating temperature: -40 to 176°F (-40 to +80°C)

363 Guida a rulli flessibile

Flexible roller guide / Flexible Röllchenführung

RANGE EXTENSION

Delivery: **Easy** **Standard**

| Part | Article-Nr. | Type | A | Colour |
|------|-------------|------|----|--------|
| 363 | 36301 | A | 8 | White |
| 363 | 36302 | B | 8 | White |
| 363 | 36303 | A | 10 | White |
| 363 | 36304 | B | 10 | White |
| 363 | 36305 | A | 8 | BluLub |
| 363 | 36306 | A | 10 | BluLub |

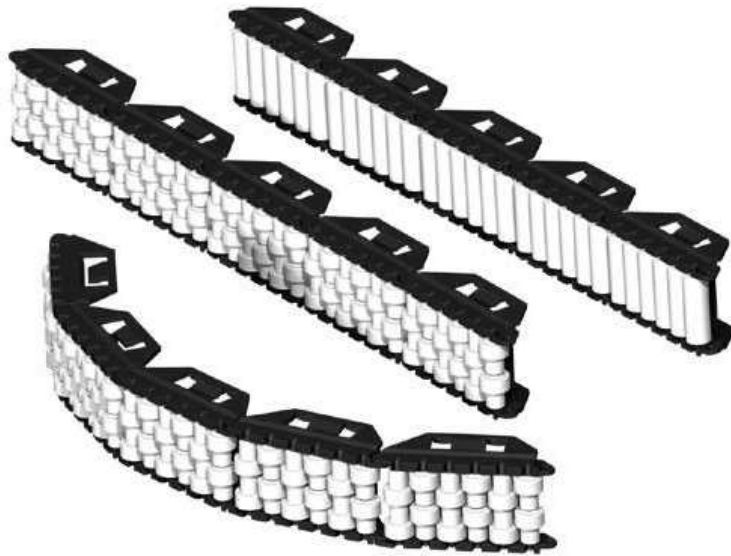

Try with...
BluLub®
 Rollers!

- Lower wear
- Noise reduction
- Improved product stability
- Lower coefficient of friction
- Less energy consumption

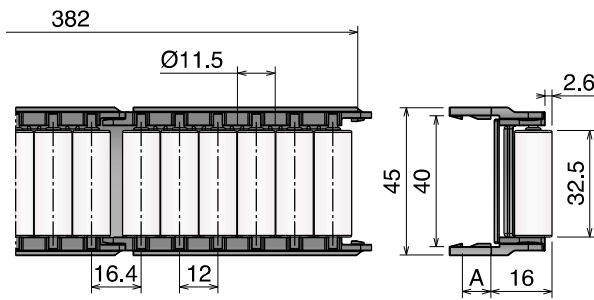

TYPE A

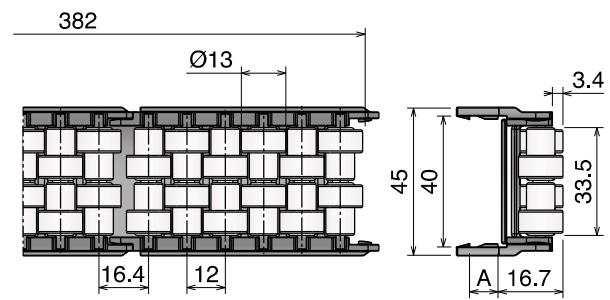

TYPE B

Curvature radius

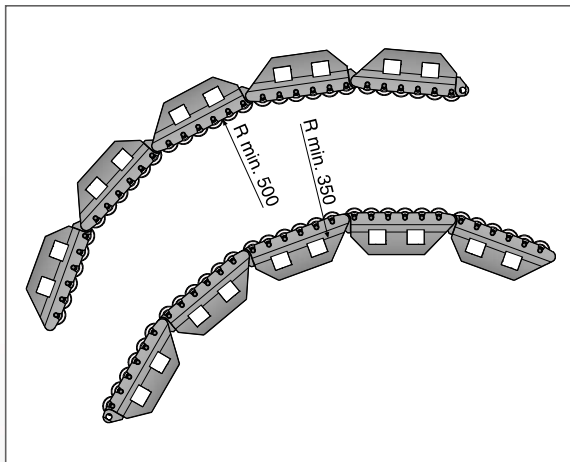

Fixing with plate and metal profile

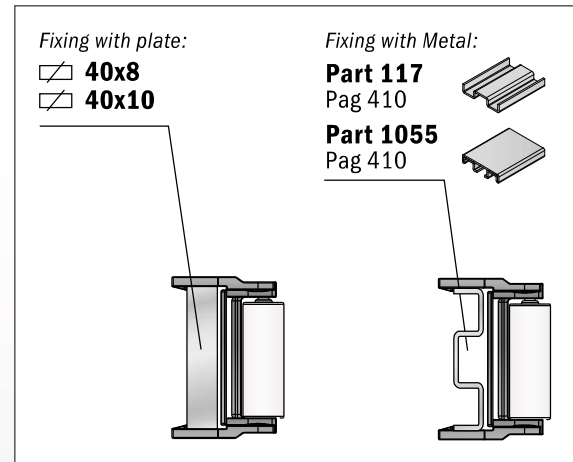

Material: Resina acetica / Acetal Resin / Azetal or **BluLub**.
 Polyethylene UHMW-PE with reduced coefficient of friction and higher wear resistance.
 BluLub complies with the code of Federal Regulations of FDA. Linear expansion coefficient:
 $1.1 \times 10^{-4} \text{ } ^\circ\text{F}^{-1}$ ($2 \times 10^{-4} \text{ } ^\circ\text{C}^{-1}$) Operating temperature: -40 to 176 °F (-40 to +80 °C)

396 Guida a rulli flessibile Flexible roller guide / Flexible Röllchenführung

RANGE EXTENSION

Delivery: **Easy** **Standard**

| Part | Article-Nr. | Type | Colour |
|------|-------------|------|--------|
| 396 | 39601 | A | White |
| 396 | 39602 | B | White |
| 396 | 39603 | A | BluLub |

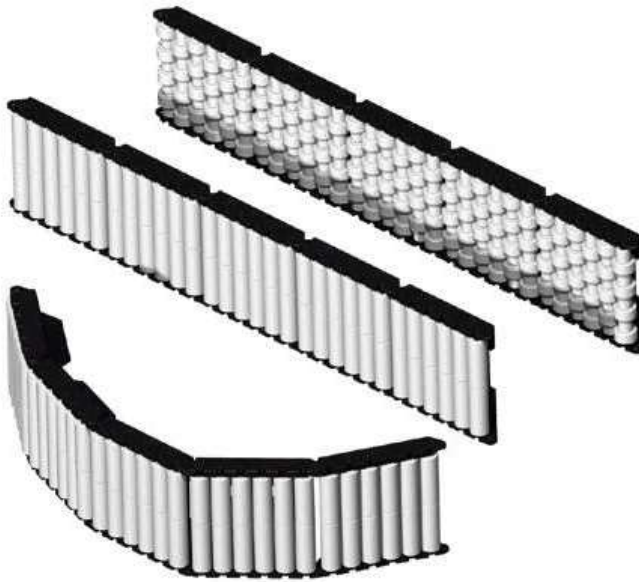

Try with...
BluLub
 Rollers!

- Lower wear
- Noise reduction
- Improved product stability
- Lower coefficient of friction
- Less energy consumption

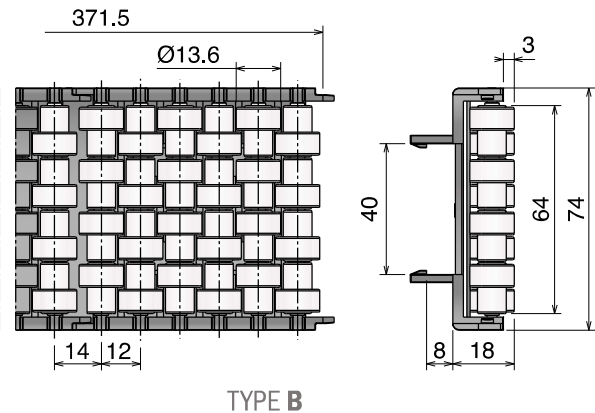
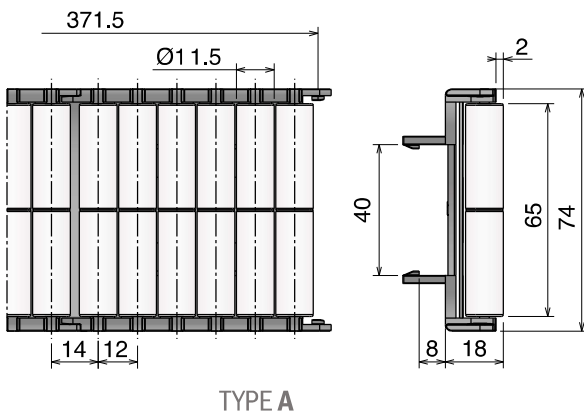

Curvature radius

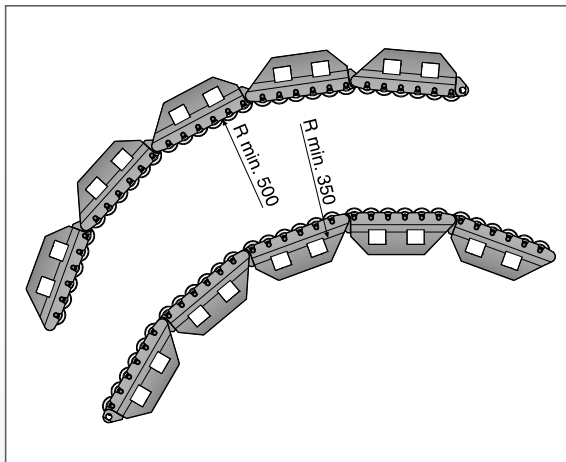

Fixing with plate and metal profile

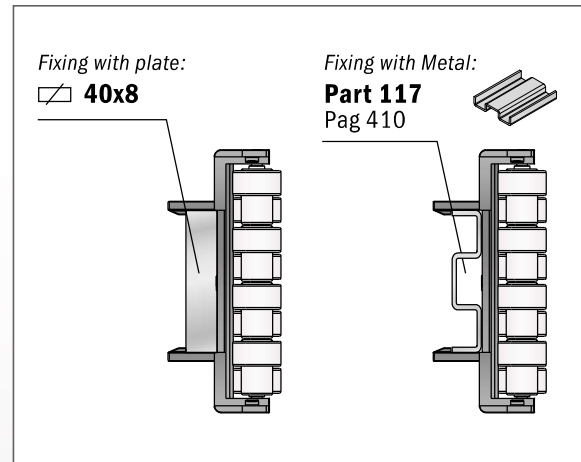

Material: Resina acetica / Acetal Resin / Azetal or **BluLub**.
 Polyethylene UHMW-PE with reduced coefficient of friction and higher wear resistance.
 BluLub complies with the code of Federal Regulations of FDA. Linear expansion coefficient:
 $1.1 \times 10^{-4} \text{ } ^\circ\text{F}^{-1}$ ($2 \times 10^{-4} \text{ } ^\circ\text{C}^{-1}$) Operating temperature: -40 to 176 $^\circ\text{F}$ (-40 to +80 $^\circ\text{C}$)

363 Guida a rulli flessibile (centrale)

Flexible roller guide (Centre) / Flexible Röllchenführung (Zentral)

Delivery: **Easy** **Standard** Can also be used with Part 117 Pag 410 - Part 1055 Pag 410

| Part | Article-Nr. | Type | For plate | Colour |
|------|-------------|------|-----------|--------|
| 363 | 36313 | A | 40x8 | White |
| 363 | 36311 | B | 40x10 | White |
| 363 | 36314 | A | 40x8 | White |
| 363 | 36312 | B | 40x10 | White |



TYPE A

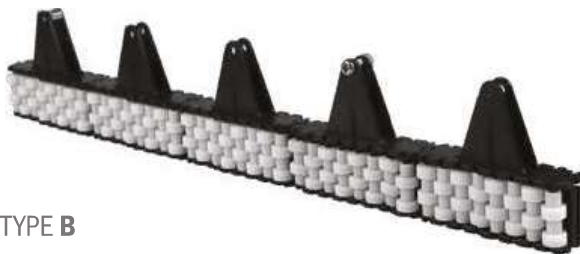
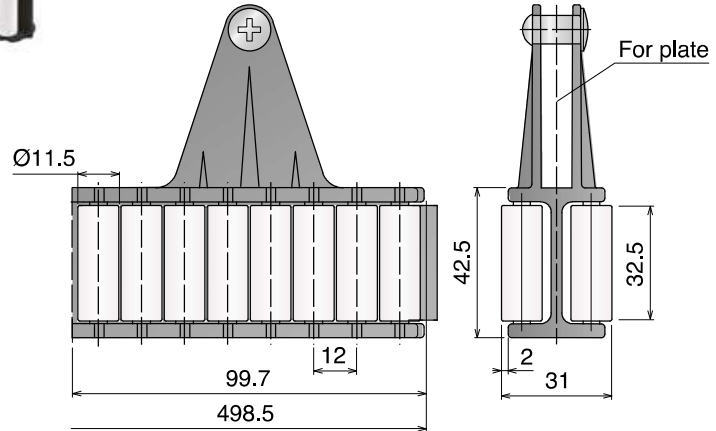

TYPE B

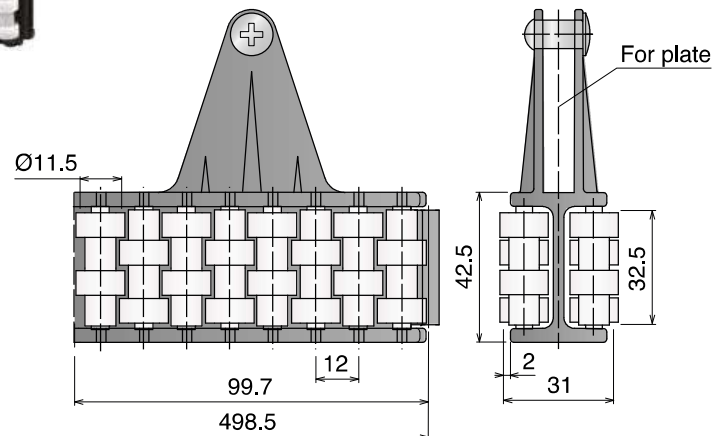

Puntale / Shoe / Einlaufschuh

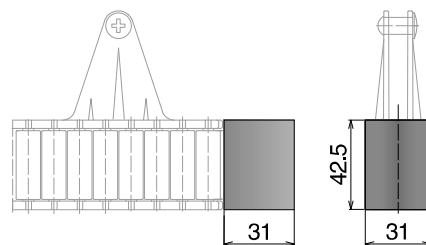

| Part | Article-Nr. | For Type |
|------|-------------|----------|
| 363 | 36399 | A & B |

