

PFX

RANGE EXTENSION

The best choice for dry running applications.

PFX is the plastic material specifically developed for chains and belts in order to run with limited lubrication or in dry applications where the demands are extreme concerning speed, performance & efficiency.

Realizing the many advantages and the versatility of our plastic compound, a growing number of companies are implementing **PFX** into their production lines with excellent results. Contact us, and request a free quotation!

Modular belts available:

Other different types of product in PFX are on request.



520 FT



520 HD FT



520 PRO LBP



520 M



525 HD FT



525 HD FG



530 PRO LBP



550 FT &
One track belt



550 FG &
One track belt



550 PRO FT



550 PRO M



551 FT



551 PRO LBP



260 M FT



260 M FG



260 TAB



261 M FT



261 TAB



Low friction

Developed to reduce friction between chain and product, and chain and wearstrip.



High performance

Longer wear life lead to excellent and long enduring product handling features.



Minimal dusting

Developed to avoid dusting under extreme circumstances.



Control of cost

Better control of total cost & sustainable conveyor technology.



Food contact Certified

PFX material is suitable in food application.



Patented material

PFX is an exclusive product of Movex.

Energy saving

Low friction

High efficiency

High visibility

FDA APPROVAL

For belt sprockets position refers to Movex engineering manual available on our website.

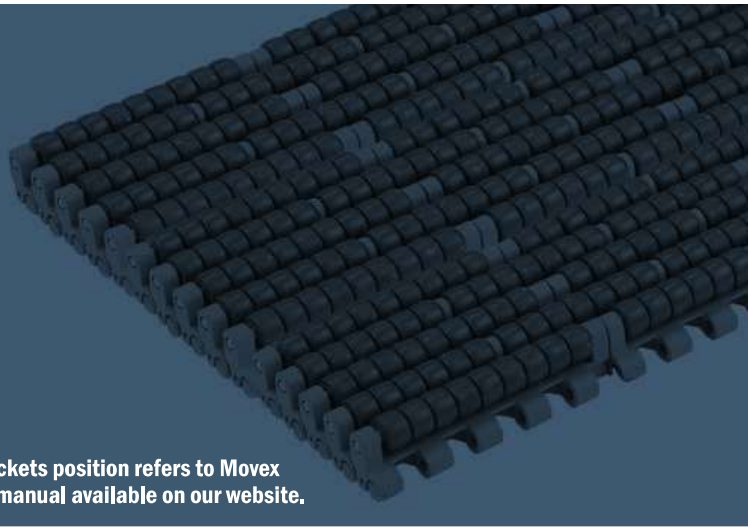

Modular belts

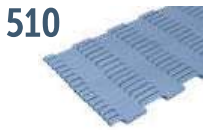

510 FT
Pag 182



522 HD FT
Pag 194

522 HD One track Belt
Pag 195



530 FT
Pag 208

530 FTT
Pag 209

530 GT
Pag 210

530 GT Side indent
Pag 211

530 LBP
Pag 212

530 PRO LBP
Pag 213



551 FT
Pag 227

551 FTT
Pag 228

551 GT
Pag 229

551 GT Side indent
Pag 230

551 LBP
Pag 231

551 PRO LBP
Pag 232

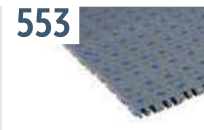

553 FLEX TOP
Pag 242/243

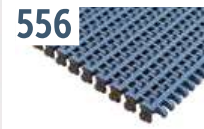

556 FT
Pag 245

556 GT
Pag 246



520 FT
Pag 184

520 HD FT
Pag 185

520 FTT
Pag 186

520 FG
Pag 187

520 GT
Pag 188

520 LBP
Pag 189

520 PRO LBP
Pag 190

520 M
Pag 191

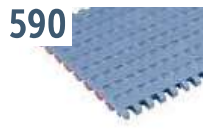

590 FT
Pag 197

590 FT One track Belt
Pag 198

590 FTT
Pag 199

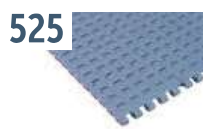

525 HD FT
Pag 201

525 HD FT + RIB
Pag 202

525 FTT
Pag 203

525 HD FG
Pag 204

525 HD GT
Pag 205

525 HD GT Side indent
Pag 206



550 FT
Pag 215

550 FT One track Belt
Pag 216

550 FTT
Pag 217

550 FG
Pag 218

550 FG One track Belt
Pag 219

550 GT
Pag 220

550 GT Side indent
Pag 221

550 FLIGHT TOP
Pag 222/223

550 PRO FT
Pag 224

550 PRO M
Pag 225

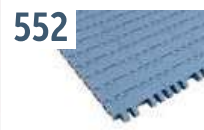

552 FT
Pag 234

552 FT One track Belt
Pag 235

552 FTT
Pag 236

552 PT
Pag 237

552 PT One track Belt
Pag 238

552 GT
Pag 239

552 GT Side indent
Pag 240

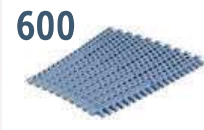

600 Standard
Pag 248

600 Heavy duty
Pag 249

600 Heavy duty with Bearings
Pag 250

600 Small radius
Pag 251

600 Heavy duty/ Small radius
Pag 252

600 Heavy duty/ Small radius with Bearings
Pag 253

600 with pusher
Pag 254

1047 Heavy duty guide
Pag 254



521 FT
Pag 193

Material Info:

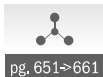

pg. 651->661

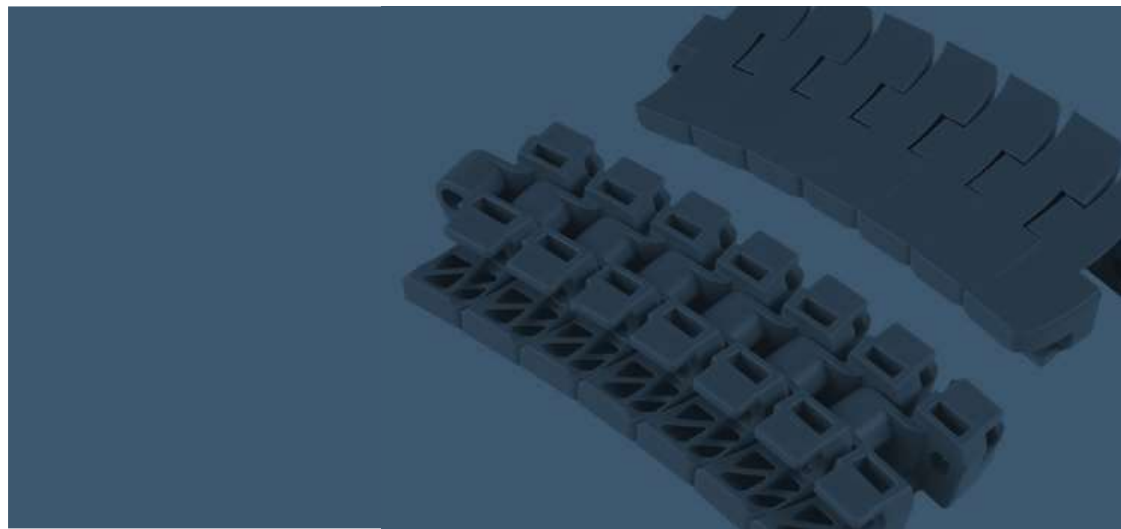

500 RR
Pag 256

500 RR with Positioner
Pag 257

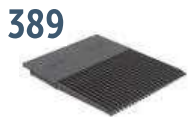

389 Combs
Pag 258



ZERO CONTACT
Pag 260/261

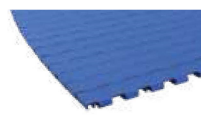

ZERO CONTACT PRO
Pag 262/263



260 M FT
Pag 265

260 M FG
Pag 266

260 TAB
Pag 267



261 M FT
Pag 268

261 TAB
Pag 269

NoseBars Standard
for Modular belt:



510 Series
Pag 273

520 Series
Pag 273

525 Series
Pag 273

521 Series
Pag 274

522 HD Series
Pag 274

530 Series
(LBP excluded) Pag 275

530 LBP
Pag 275

530 PRO LBP
Pag 276

NoseBars with Bearings
for Modular belt:



520 Series
Pag 277

525 Series
Pag 277

521 Series
Pag 277

522 HD Series
Pag 278

530 Series
(LBP excluded) Pag 278

530 LBP
Pag 279

530 PRO LBP
Pag 279

NoseBars with Rollers
for Modular belt:



520 Series
Pag 280

525 Series
Pag 280

521 Series
Pag 280

522 HD Series
Pag 281

530 Series
(LBP excluded) Pag 281

One piece

Custom made NoseBar, supplied in a single piece.

One piece is the system patented by Movex that greatly reduces the time necessary for the conveyor maintenance: being a single piece, of the required size, it is quick to install and easy to clean.

Standard
for Modular belt:



520 Series
Pag 282

525 Series
Pag 282

522 HD Series
Pag 282

530 Series
Pag 282

with Bearings
for Modular belt:



520 Series
Pag 283

525 Series
Pag 283

522 HD Series
Pag 283

530 Series
Pag 283

with Rollers
for Modular belt:



520 Series
Pag 284

525 Series
Pag 284

522 HD Series
Pag 284

530 Series
Pag 284

510 Series

510

Pitch 8 mm
H= 6 mm



510 FT

Movex[®]

510 FT

Tappeto Modulare 510 FT, H=6 M=3"
Modular Belt Series 510 FT, H=6 M=3" / Modulare Mattenkette 510 FT, H=6 M=3"

CODE STRUCTURE GUIDE (Example)

Backflex radius min.: 7.5 mm

5331	01	0012	A
Series	*Material	Width	Version



SAMPLE BOX

Art.-Nr. **5331018888A**



- Easier installation
- Quicker maintenance



8 mm
PITCH

*** Material**

LFA - Code 01

Low friction Acetal

Easy Delivery

Max w. load: 3000 N/m
Weight: 5,8 kg/m²
Temp. range dry: -40+80 °C
Temp. range wet: -40+65 °C
Pin material: PBT grey

MX - Code 03

Performance PBT

Max w. load: 2700 N/m
Weight: 5,5 kg/m²
Temp. range dry: -40+120 °C
Temp. range wet: -40+60 °C
Pin material: POM grey

LFB - Code 23

Low friction Acetal

Max w. load: 3000 N/m
Weight: 5,8 kg/m²
Temp. range dry: -40+80 °C
Temp. range wet: -40+65 °C
Pin material: PBT grey

Version A - Standard

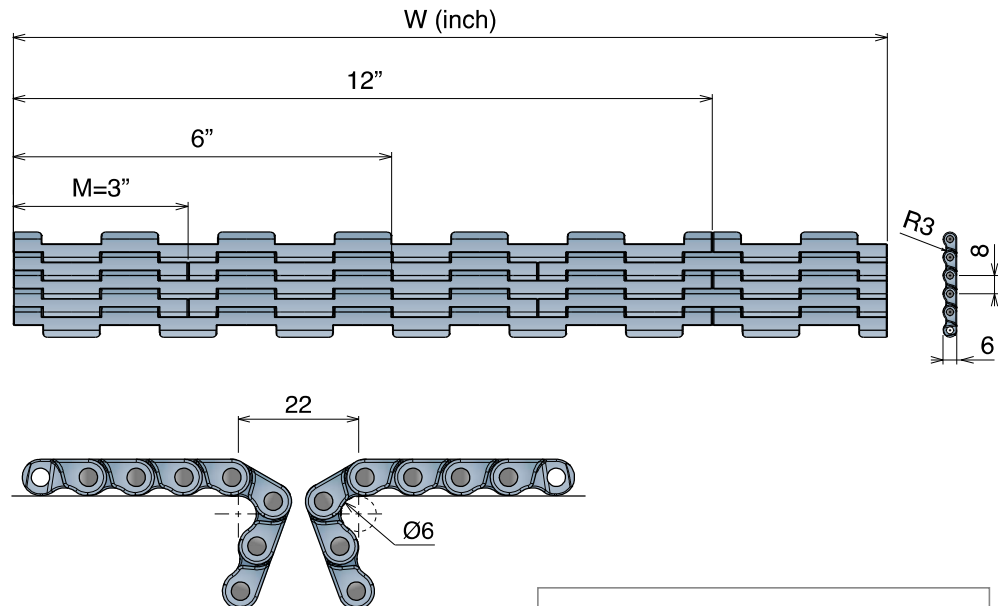

Version A - Standard

Series	Material	Width	Version
5331	*	0003	A
5331	*	0006	A
5331	*	0009	A
5331	*	0012	A
5331	*	0015	A
5331	*	0018	A
5331	*	0021	A
5331	*	0024	A
5331	*	0027	A
5331	*	0030	A
5331	*	0033	A
5331	*	0036	A
5331	*	0039	A
5331	*	0042	A
5331	*	0045	A
5331	*	0048	A

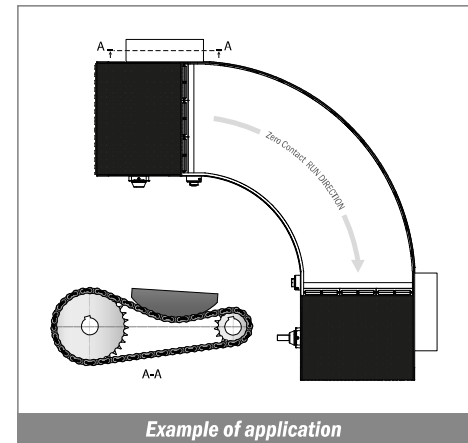

Example of application

NEW

510 FT
MOVEX TOOL

Developed to facilitate belt assembly and disassembly.



Article Nr. **29969**

Movex tools are made with 3D printer, the color may vary due to availability of the material.

520

Pitch 12,7 mm
H= 8,7 mm



520 FT
520 HD FT
520 FTT
520 FG
520 GT
520 LBP

520 PRO LBP
520 M

520 FT

Tappeto Modulare 520 FT, H=8,7 M=85
Modular Belt Series 520 FT, H=8,7 M=85 / Modulare Mattenkette 520 FT, H=8,7 M=85

Metric Size

CODE STRUCTURE GUIDE (Example)

5201	01	0085	A
Series	*Material	Width	Version

pg. 315-316	273/277/280	pg. 651>661

SAMPLE BOX	
Art.-Nr.	5201018888A

Backflex radius min.: 10 mm

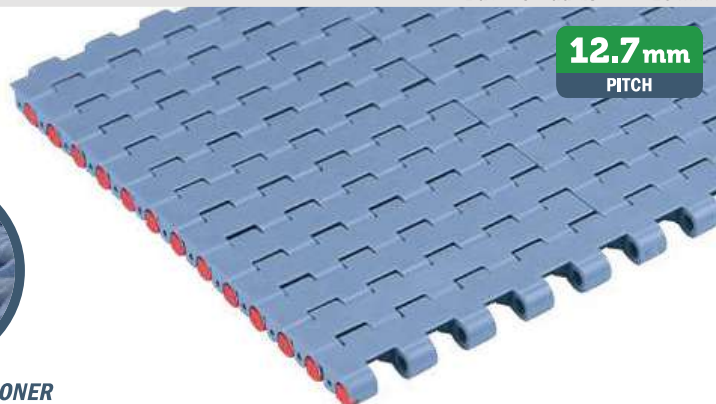

REINFORCED POSITIONER

*Material

LFA - Code 01 Low friction Acetal

Easy Delivery

Max w. load: 21500 N/m
Weight: 7,8 kg/m²
Temp. range dry: -40+80 °C
Temp. range wet: -40+65 °C
Pin material: PBT white

PP - Code 02 Polypropylene

Max w. load: 13000 N/m
Weight: 7,5 kg/m²
Temp. range dry: 4+104 °C
Temp. range wet: 4+104 °C
Pin material: PP blue

MX - Code 03 Performance PBT

Max w. load: 17500 N/m
Weight: 7,5 kg/m²
Temp. range dry: -40+120 °C
Temp. range wet: -40+60 °C
Pin material: POM grey

LFB - Code 23 Low friction Acetal

Max w. load: 21500 N/m
Weight: 7,8 kg/m²
Temp. range dry: -40+80 °C
Temp. range wet: -40+65 °C
Pin material: PBT white

MPX - Code 25 Lubricated Acetal

Max w. load: 21500 N/m
Weight: 7,8 kg/m²
Temp. range dry: -40+80 °C
Temp. range wet: -40+65 °C
Pin material: PBT white

PFX - Code 30 Extra performance PBT

Max w. load: 17500 N/m
Weight: 7,5 kg/m²
Temp. range dry: -40+120 °C
Temp. range wet: -40+60 °C
Pin material: POM grey

**THE BEST CHOICE FOR
DRY RUNNING APPLICATIONS**

Version A - Standard

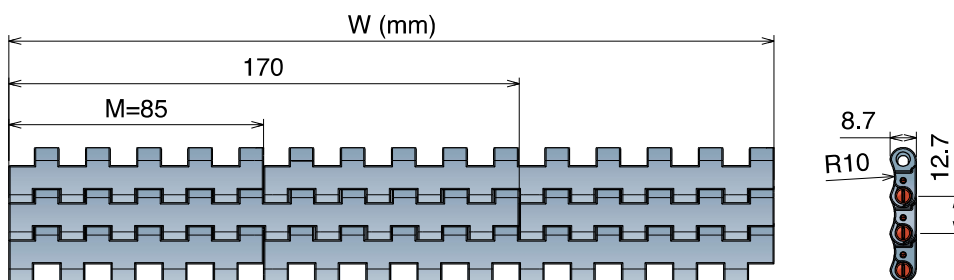

Version B - With 1 Positioner

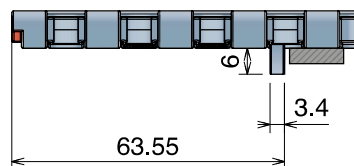

Version C - With 2 Positioner

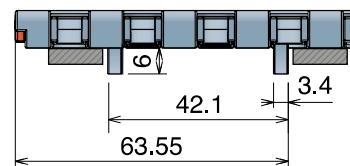

Version A - Standard

Series	Material	Width	Version
5201	*	0085	A
5201	*	0170	A
5201	*	0255	A
5201	*	0340	A
5201	*	0425	A
5201	*	0510	A
5201	*	0595	A
5201	*	0680	A
5201	*	0765	A
5201	*	0850	A
5201	*	0935	A
5201	*	1020	A
5201	*	1105	A
5201	*	1190	A
5201	*	1275	A
5201	*	1360	A
5201	*	1445	A
5201	*	1530	A

Version B - With 1 Positioner

Series	Material	Width	Version
5201	*	0085	B
5201	*	0170	B
5201	*	0255	B
5201	*	0340	B
5201	*	0425	B
5201	*	0510	B
5201	*	0595	B
5201	*	0680	B
5201	*	0765	B
5201	*	0850	B
5201	*	0935	B
5201	*	1020	B
5201	*	1105	B
5201	*	1190	B
5201	*	1275	B
5201	*	1360	B
5201	*	1445	B
5201	*	1530	B

Version C - With 2 Positioners

Series	Material	Width	Version
5201	*	0085	C
5201	*	0170	C
5201	*	0255	C
5201	*	0340	C
5201	*	0425	C
5201	*	0510	C
5201	*	0595	C
5201	*	0680	C
5201	*	0765	C
5201	*	0850	C
5201	*	0935	C
5201	*	1020	C
5201	*	1105	C
5201	*	1190	C
5201	*	1275	C
5201	*	1360	C
5201	*	1445	C
5201	*	1530	C

520 HD FT

Tappeto Modulare 520 HD, H=8,7 M=85
Modular Belt Series 520 HD, H=8,7 M=85 / Modulare Mattenkette 520 HD, H=8,7 M=85

CODE STRUCTURE GUIDE (Example)

5211	01	0085	A
Series	*Material	Width	Version

pg. 313-314	273/277/280	pg. 651⇒661

SAMPLE BOX

Art.-Nr. **5211018888A**

Backflex radius min.: 10 mm

12.7 mm
PITCH

Metric Size

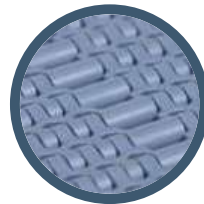

*Material

LFA - Code 01

Low friction Acetal

Easy Delivery

Max w. load: 25500 N/m
Weight: 7,8 kg/m²
Temp. range dry: -40÷80 °C
Temp. range wet: -40÷65 °C
Pin material: PBT white

MX - Code 03

Performance PBT

Max w. load: 20000 N/m
Weight: 7,5 kg/m²
Temp. range dry: -40÷120 °C
Temp. range wet: -40÷60 °C
Pin material: POM grey

MPX - Code 25

Lubricated Acetal

Max w. load: 25000 N/m
Weight: 7,8 kg/m²
Temp. range dry: -40÷80 °C
Temp. range wet: -40÷65 °C
Pin material: PBT white

PFX - Code 30

Extra performance PBT

Max w. load: 20000 N/m
Weight: 7,5 kg/m²
Temp. range dry: -40÷120 °C
Temp. range wet: -40÷60 °C
Pin material: POM grey

**THE BEST CHOICE FOR
DRY RUNNING APPLICATIONS**

Version A - Standard

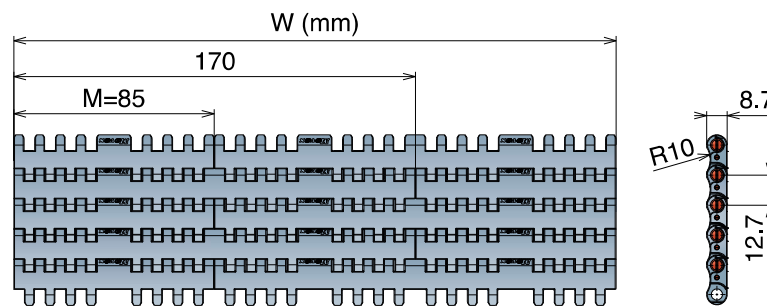

Version B - With 1 Positioner

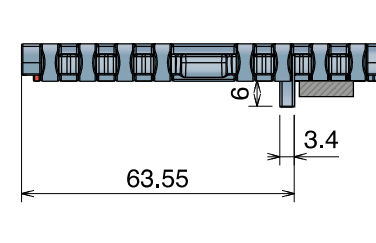

Version C - With 2 Positioner

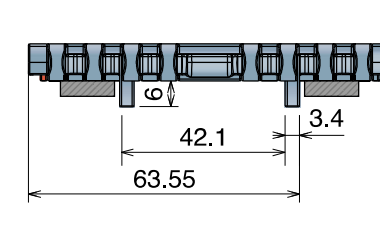

Version A - Standard

Series	Material	Width	Version
5211	*	0085	A
5211	*	0170	A
5211	*	0255	A
5211	*	0340	A
5211	*	0425	A
5211	*	0510	A
5211	*	0595	A
5211	*	0680	A

Version B - With 1 Positioner

Series	Material	Width	Version
5211	*	0085	B
5211	*	0170	B
5211	*	0255	B
5211	*	0340	B
5211	*	0425	B
5211	*	0510	B
5211	*	0595	B
5211	*	0680	B

Version C - With 2 Positioners

Series	Material	Width	Version
5211	*	0085	C
5211	*	0170	C
5211	*	0255	C
5211	*	0340	C
5211	*	0425	C
5211	*	0510	C
5211	*	0595	C
5211	*	0680	C



Advantages:

- Improved working load
- Rigidity
- Easy installation
- Product stability

520 FTT

Tappeto Modulare 520 FTT, H=8,7 M=85
 Modular Belt Series 520 FTT, H=8,7 M=85 / Modulare Mattenkette 520 FTT, H=8,7 M=85

Metric Size

CODE STRUCTURE GUIDE (Example)

5206	01	0085	C
Series	*Material	Width	Version

	NoseBars	
pg. 315-316	273/277/280	pg. 651-661

*Material

LFA - Code 01 Low friction Acetal		MX - Code 03 Performance PBT	
Max w. load:	21500 N/m	Max w. load:	17500 N/m
Weight:	7,8 kg/m ²	Weight:	7,5 kg/m ²
Temp. range dry:	-40+80 °C	Temp. range dry:	-40+120 °C
Temp. range wet:	-40+65 °C	Temp. range wet:	40+60 °C
Pin material:	PBT white	Pin material:	POM grey

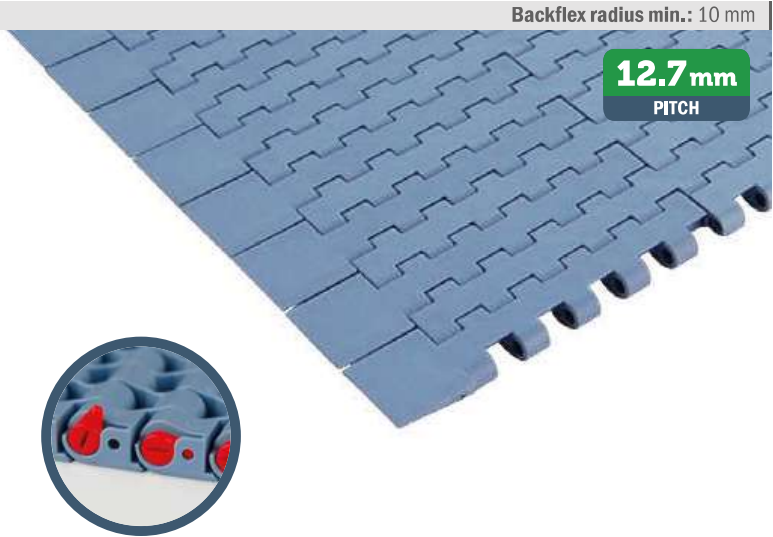

Backflex radius min.: 10 mm

12.7 mm
PITCH

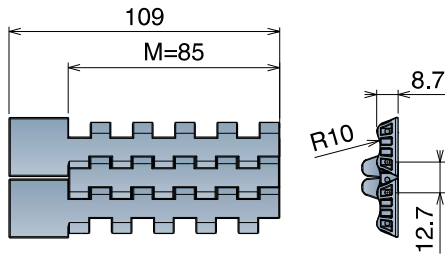

Version C

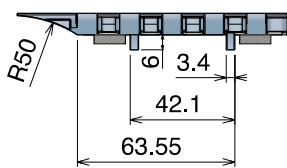

Version C

Series	Material	Width	Version
5206	*	0085	C

Max working load (N)

Width	85
LFA	1850
MX	1500

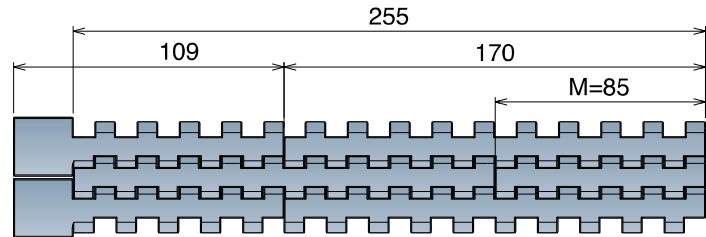

Version CN - Near

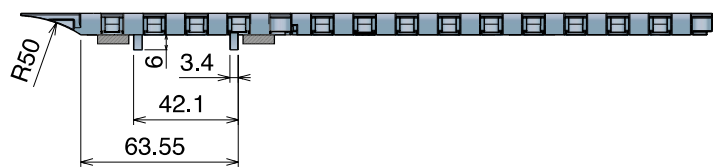

Version C0 - Opposite



Version CN - Near

Series	Material	Width	Version
5206	*	0170	CN
5206	*	0255	CN

Version C0 - Opposite

Series	Material	Width	Version
5206	*	0170	C0
5206	*	0255	C0

520 FG Open Surface 25% Tappeto Modulare 520 FG, H=8,7 M=85 Modular Belt Series 520 FG, H=8,7 M=85 / Modulare Mattenkette 520 FG, H=8,7 M=85

CODE STRUCTURE GUIDE (Example)

Backflex radius min.: 10 mm

5202	01	0085	A
Series	*Material	Width	Version

pg. 315-316	273/277/280	pg. 651→661

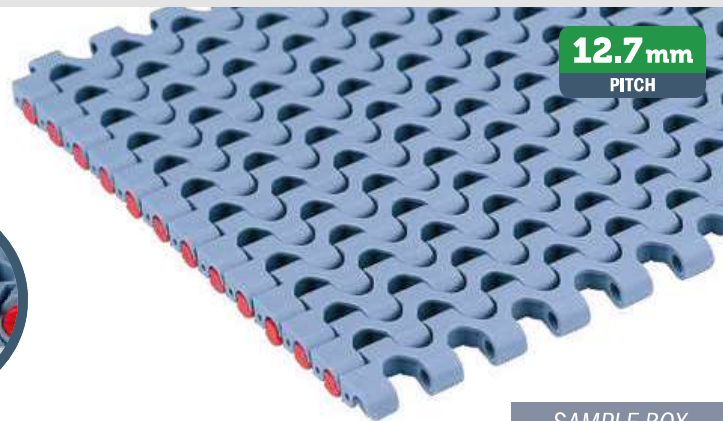

12.7 mm
PITCH

Metric Size

* Material

LFA - Code 01
Low friction Acetal

Easy Delivery

Max w. load: 21500 N/m
Weight: 7,5 kg/m²
Temp. range dry: -40+80 °C
Temp. range wet: -40+65 °C
Pin material: PBT white

PP - Code 02
Polypropylene

Max w. load: 13000 N/m
Weight: 7,5 kg/m²
Temp. range dry: 4+104 °C
Temp. range wet: 4+104 °C
Pin material: PP blue

MX - Code 03
Performance PBT

Max w. load: 17500 N/m
Weight: 7,2 kg/m²
Temp. range dry: -40+120 °C
Temp. range wet: -40+60 °C
Pin material: POM grey

DKM - Code 16
Aramide Reinforced Acetal

Max w. load: 21500 N/m
Weight: 7,5 kg/m²
Temp. range dry: -40+80 °C
Temp. range wet: -40+65 °C
Pin material: PBT white

MWX - Code 17
Polyamide Composite

Max w. load: 21500 N/m
Weight: 7,8 kg/m²
Temp. range dry: -40+104 °C
Temp. range wet: NR
Pin material: PBT white

LFB - Code 23
Low friction Acetal

Max w. load: 21500 N/m
Weight: 7,5 kg/m²
Temp. range dry: -40+80 °C
Temp. range wet: -40+65 °C
Pin material: PBT white

MPX - Code 25
Lubricated Acetal

Max w. load: 21500 N/m
Weight: 7,5 kg/m²
Temp. range dry: -40+80 °C
Temp. range wet: -40+65 °C
Pin material: PBT white

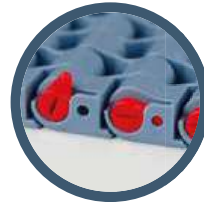

SAMPLE BOX

Art.-Nr. **520201888A**

Version A - Standard

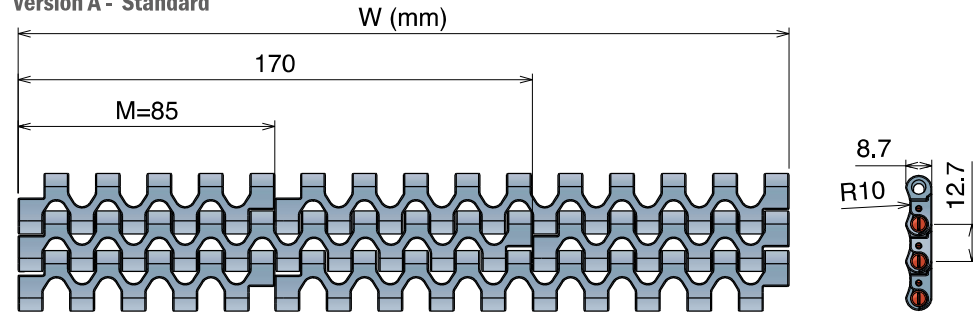

Version B - With 1 Positioner

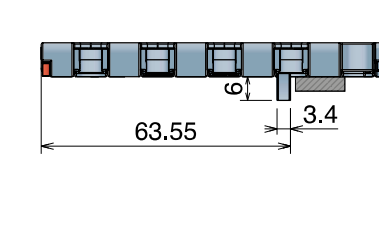

Version C - With 2 Positioner

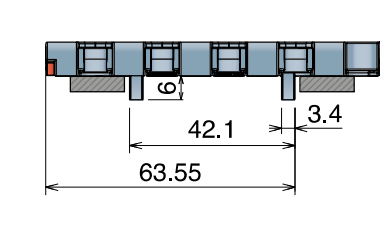

Version A - Standard

Series	Material	Width	Version
5202	*	0085	A
5202	*	0170	A
5202	*	0255	A
5202	*	0340	A
5202	*	0425	A
5202	*	0510	A
5202	*	0595	A
5202	*	0680	A
5202	*	0765	A
5202	*	0850	A
5202	*	0935	A
5202	*	1020	A
5202	*	1105	A
5202	*	1190	A
5202	*	1275	A
5202	*	1360	A
5202	*	1445	A
5202	*	1530	A

Version B - With 1 Positioner

Series	Material	Width	Version
5202	*	0085	B
5202	*	0170	B
5202	*	0255	B
5202	*	0340	B
5202	*	0425	B
5202	*	0510	B
5202	*	0595	B
5202	*	0680	B
5202	*	0765	B
5202	*	0850	B
5202	*	0935	B
5202	*	1020	B
5202	*	1105	B
5202	*	1190	B
5202	*	1275	B
5202	*	1360	B
5202	*	1445	B
5202	*	1530	B

Version C - With 2 Positioners

Series	Material	Width	Version
5202	*	0085	C
5202	*	0170	C
5202	*	0255	C
5202	*	0340	C
5202	*	0425	C
5202	*	0510	C
5202	*	0595	C
5202	*	0680	C
5202	*	0765	C
5202	*	0850	C
5202	*	0935	C
5202	*	1020	C
5202	*	1105	C
5202	*	1190	C
5202	*	1275	C
5202	*	1360	C
5202	*	1445	C
5202	*	1530	C

520 GT

Tappeto Modulare 520 GT, H=8,7 M=85
Modular Belt Series 520 GT, H=8,7 M=85 / Modulare Mattenkette 520 GT, H=8,7 M=85

CODE STRUCTURE GUIDE (Example)

Backflex radius min.: 20 mm

5203	01	0085	A
Series	*Material	Width	Version

	NoseBars	
pg. 315-316	273/277/280	pg. 651>661

SAMPLE BOX	
Art.-Nr.	520301888A

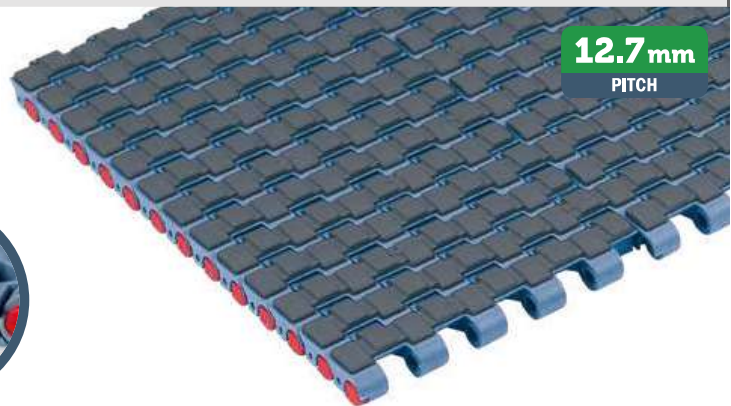
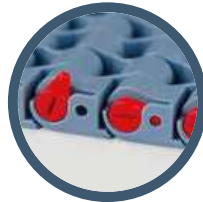

12.7 mm
PITCH

Metric Size

*Material

LFA - Code 01
Low friction Acetal

Easy Delivery

Max w. load: 21500 N/m
Weight: 9,0 kg/m²
Temp. range dry: -40+80 °C
Temp. range wet: -40+65 °C
Pin material: PBT white
Top rubber: 50 Sha-Dark grey

PP - Code 02
Polypropylene

Max w. load: 13000 N/m
Weight: 7,5 kg/m²
Temp. range dry: 4+80 °C
Temp. range wet: 4+80 °C
Pin material: PP blu
Top rubber: 50 Sha-Pigeon blue

MX - Code 03
Performance PBT

Max w. load: 17500 N/m
Weight: 9,3 kg/m²
Temp. range dry: -40+120 °C
Temp. range wet: -40+60 °C
Pin material: POM grey
Top rubber: 50 Sha-Dark grey

Version A - Standard

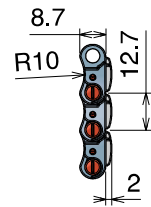
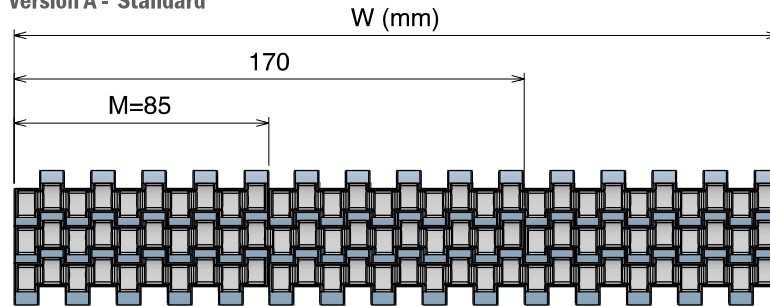

Version B - With 1 Positioner

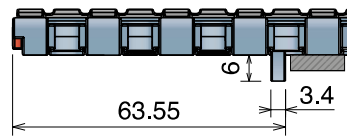

Version C - With 2 Positioners

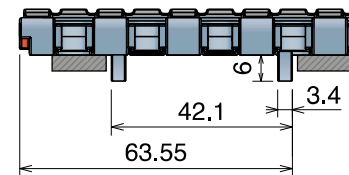

Version A - Standard

Series	Material	Width	Version
5203	*	0085	A
5203	*	0170	A
5203	*	0255	A
5203	*	0340	A
5203	*	0425	A
5203	*	0510	A
5203	*	0595	A
5203	*	0680	A
5203	*	0765	A
5203	*	0850	A
5203	*	0935	A
5203	*	1020	A
5203	*	1105	A
5203	*	1190	A
5203	*	1275	A
5203	*	1360	A
5203	*	1445	A
5203	*	1530	A

Version B - With 1 Positioner

Series	Material	Width	Version
5203	*	0085	B
5203	*	0170	B
5203	*	0255	B
5203	*	0340	B
5203	*	0425	B
5203	*	0510	B
5203	*	0595	B
5203	*	0680	B
5203	*	0765	B
5203	*	0850	B
5203	*	0935	B
5203	*	1020	B
5203	*	1105	B
5203	*	1190	B
5203	*	1275	B
5203	*	1360	B
5203	*	1445	B
5203	*	1530	B

Version C - With 2 Positioners

Series	Material	Width	Version
5203	*	0085	C
5203	*	0170	C
5203	*	0255	C
5203	*	0340	C
5203	*	0425	C
5203	*	0510	C
5203	*	0595	C
5203	*	0680	C
5203	*	0765	C
5203	*	0850	C
5203	*	0935	C
5203	*	1020	C
5203	*	1105	C
5203	*	1190	C
5203	*	1275	C
5203	*	1360	C
5203	*	1445	C
5203	*	1530	C

520 LBP

Tappeto Modulare 520 LBP, H=8,7 M=85
Modular Belt Series 520 LBP, H=8,7 M=85 / Modulare Mattenkette 520 LBP, H=8,7 M=85

CODE STRUCTURE GUIDE (Example)

5204	01	0085	A
Series	*Material	Width	Version

Backflex radius min.: 65 mm

	NoseBars	
pg. 315-316	273/277/280	pg. 651-661

SAMPLE BOX

Art.-Nr. **5204010888A**

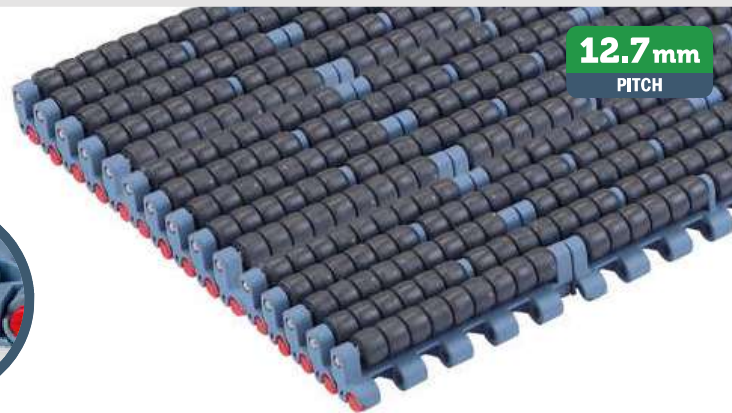
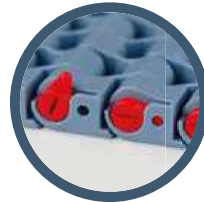

Metric Size

Version A - Standard

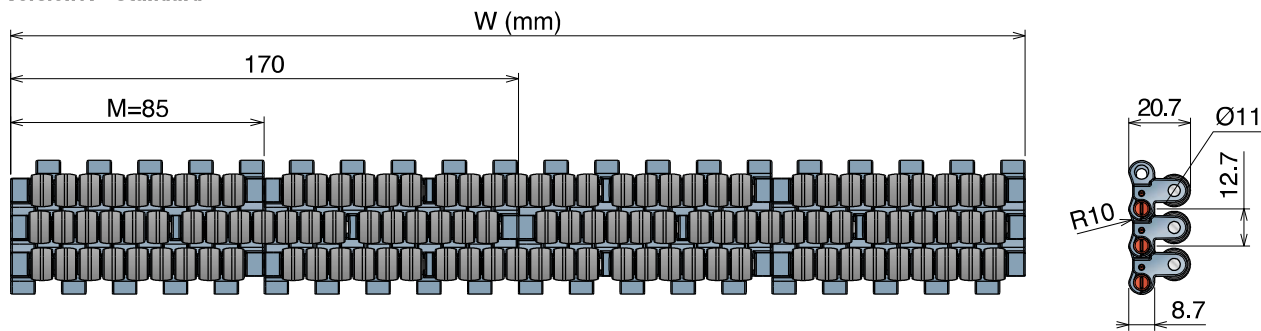

*Material

LFA - Code 01 Low friction Acetal

Max w. load: 21500 N/m
Weight: 24,0 kg/m²
Temp. range dry: -40÷80 °C
Temp. range wet: 1÷65 °C
Pin material: PBT white

Version B - With 1 Positioner

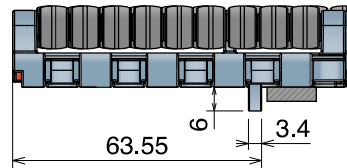

Version C - With 2 Positioners

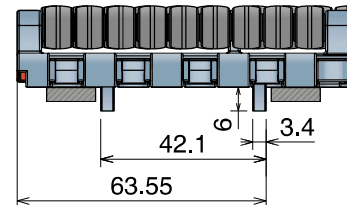

Version A - Standard

Series	Material	Width	Version
5204	01	0085	A
5204	01	0170	A
5204	01	0255	A
5204	01	0340	A
5204	01	0425	A
5204	01	0510	A
5204	01	0595	A
5204	01	0680	A
5204	01	0765	A
5204	01	0850	A
5204	01	0935	A
5204	01	1020	A
5204	01	1105	A
5204	01	1190	A
5204	01	1275	A
5204	01	1360	A
5204	01	1445	A
5204	01	1530	A

Version B - With 1 Positioner

Series	Material	Width	Version
5204	01	0085	B
5204	01	0170	B
5204	01	0255	B
5204	01	0340	B
5204	01	0425	B
5204	01	0510	B
5204	01	0595	B
5204	01	0680	B
5204	01	0765	B
5204	01	0850	B
5204	01	0935	B
5204	01	1020	B
5204	01	1105	B
5204	01	1190	B
5204	01	1275	B
5204	01	1360	B
5204	01	1445	B
5204	01	1530	B

Version C - With 2 Positioners

Series	Material	Width	Version
5204	01	0085	C
5204	01	0170	C
5204	01	0255	C
5204	01	0340	C
5204	01	0425	C
5204	01	0510	C
5204	01	0595	C
5204	01	0680	C
5204	01	0765	C
5204	01	0850	C
5204	01	0935	C
5204	01	1020	C
5204	01	1105	C
5204	01	1190	C
5204	01	1275	C
5204	01	1360	C
5204	01	1445	C
5204	01	1530	C

520 PRO LBP

Tappeti modulari / Modular belts / Mattenketten

PATENTED

Belts wider than standard are available with 85 mm increments

520 PRO LBP

Tappeto Modulare 520 PRO LBP, H=8,7 M=85

Modular Belt Series 520 PRO LBP, H=8,7 M=85 / Modulare Mattenkette 520 PRO LBP, H=8,7 M=85

CODE STRUCTURE GUIDE (Example)

Backflex radius min.: 40 mm

5209	01	0085	A
Series	*Material	Width	Version

pg. 315-316	273/277/280	pg. 651>661

SAMPLE BOX

Art.-Nr. **521001888A**

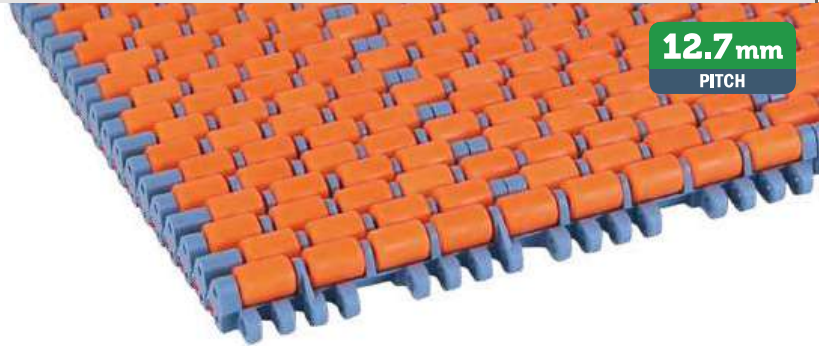

12.7 mm
PITCH

Metric Size

Material

LFA - Code 01
Low friction Acetal

Max w. load: 25000 N/m
Weight SS pin: 19,0 kg/m²
Weight Plastic pin: 15,3 kg/m²
Temp. range dry: -40+80 °C
Temp. range wet: -40+65 °C
Pin material: PBT white

PFX Roller

**THE BEST CHOICE TO REACH
THE LOWEST FRICTION**



Bottom view

Version A - Standard

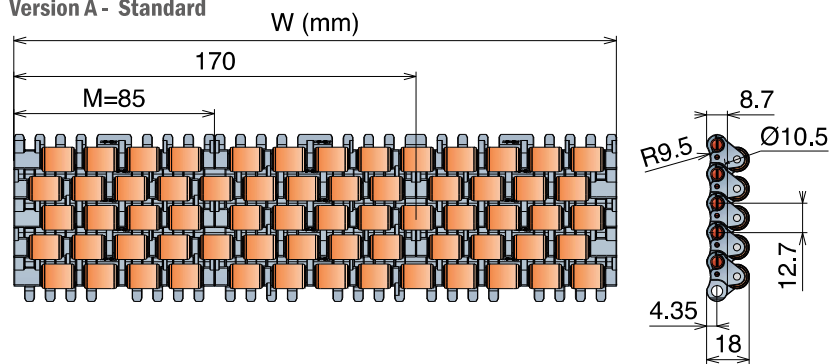

Version B - With 1 Positioner

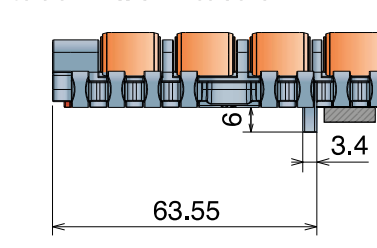

Version C - With 2 Positioner

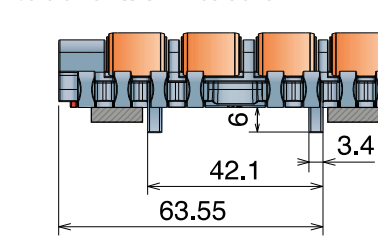

**Stainless steel
Pin**



Plastic Pin

Series	Material	Width	Version
5209	01	0085	*
5209	01	0170	*
5209	01	0255	*
5209	01	0340	*
5209	01	0425	*
5209	01	0510	*
5209	01	0595	*
5209	01	0680	*
5209	01	0765	*
5209	01	0850	*
5209	01	0935	*
5209	01	1020	*
5209	01	1105	*
5209	01	1190	*
5209	01	1275	*
5209	01	1360	*
5209	01	1445	*
5209	01	1530	*

Series	Material	Width	Version
5210	01	0085	*
5210	01	0170	*
5210	01	0255	*
5210	01	0340	*
5210	01	0425	*
5210	01	0510	*
5210	01	0595	*
5210	01	0680	*
5210	01	0765	*
5210	01	0850	*
5210	01	0935	*
5210	01	1020	*
5210	01	1105	*
5210	01	1190	*
5210	01	1275	*
5210	01	1360	*
5210	01	1445	*
5210	01	1530	*

*Version

Standard	Add A
With 1 Positioner	Add B
With 2 Positioners	Add C

521/522 Series

521/522

Pitch 12,7 mm

H= 8,7 mm



Imperial Size

Metric Size

Movex[®]

521 FT

522 HD FT

522 HD FT *One track belt*

521 FT

Tappeto Modulare 521 FT, H=8,7 M=7,5"
 Modular Belt Series 521 FT, H=8,7 M=7,5" / Modulare Mattenkette 521 FT, H=8,7 M=7,5"

CODE STRUCTURE GUIDE (Example)

Backflex radius min.: 10 mm

5311	01	9750	A
Series	*Material	Width	Version

12.7 mm
PITCH

	NoseBars	
pg. 315-316	274/277/280	pg. 651⇒661

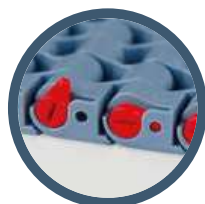

Imperial Size

*** Material**

LFA - Code 01

Low friction Acetal

Easy Delivery

Max w. load: 4000 N
 Weight: 8,0 kg/m²
 Temp. range dry: -40÷80 °C
 Temp. range wet: -40÷65 °C
 Pin material: PBT white

MX - Code 03

Performance PBT

Max w. load: 3300 N
 Weight: 7,8 kg/m²
 Temp. range dry: -40÷120 °C
 Temp. range wet: -40÷60 °C
 Pin material: POM grey

DKM - Code 16

Aramide Reinforced Acetal

Max w. load: 4000 N
 Weight: 8,0 kg/m²
 Temp. range dry: -40÷80 °C
 Temp. range wet: -40÷65 °C
 Pin material: PBT white

MWX - Code 17

Polyamide Composite

Max w. load: 4000 N
 Weight: 8,3 kg/m²
 Temp. range dry: -40÷104 °C
 Temp. range wet: NR
 Pin material: PBT white

MPX - Code 25

Lubricated Acetal

Max w. load: 4000 N
 Weight: 8,0 kg/m²
 Temp. range dry: -40÷80 °C
 Temp. range wet: -40÷65 °C
 Pin material: PBT white

Version A - Standard

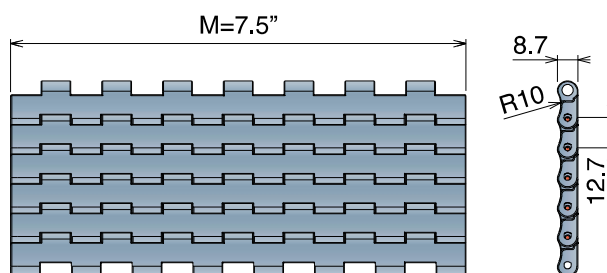

Version C - With 2 Positioner

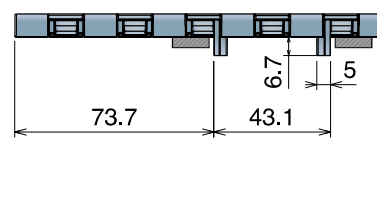

Version A - Standard

Series	Material	Width	Version
5311	*	9750	A

Version C - With 2 Positioners

Series	Material	Width	Version
5311	*	9750	C

NEW

522 HD FT

Tappeto Modulare 522 HD, H=8,7 M=50
Modular Belt Series 522 HD, H=8,7 M=50 / Modulare Mattenkette 522 HD, H=8,7 M=50

CODE STRUCTURE GUIDE (Example)

Backflex radius min.: 10 mm

5271	01	0100	A
Series	*Material	Width	Version

pg. 313-314	274/278/281	pg. 651-661

12.7 mm
PITCH



Metric Size

*Material

LFA - Code 01

Low friction Acetal

Easy Delivery

Max w. load: 25500 N/m
Weight: 7,8 kg/m²
Temp. range dry: -40+80 °C
Temp. range wet: -40+65 °C
Pin material: PBT white

MX - Code 03

Performance PBT

Max w. load: 20000 N/m
Weight: 7,5 kg/m²
Temp. range dry: -40+120 °C
Temp. range wet: -40+60 °C
Pin material: POM grey

PFX - Code 30

Extra performance PBT

Max w. load: 20000 N/m
Weight: 7,5 kg/m²
Temp. range dry: -40+120 °C
Temp. range wet: -40+60 °C
Pin material: POM grey

**THE BEST CHOICE FOR
DRY RUNNING APPLICATIONS**

Version A - Standard

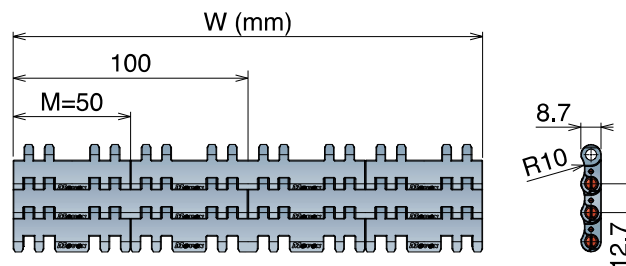

Version C - With 2 Positioner

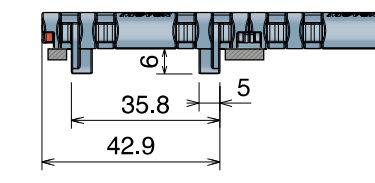

Version A - Standard

Series	Material	Width	Version
5271	*	0100**	A
5271	*	0150	A
5271	*	0200	A
5271	*	0250	A
5271	*	0300	A

Version C - With 2 Positioners

Series	Material	Width	Version
5271	*	0100**	C
5271	*	0150	C
5271	*	0200	C
5271	*	0250	C
5271	*	0300	C

** Belt assembled with Pin Sphere.

NEW

522 HD One track belt MOVEX TOOL

The specific tool for belts developed to facilitate belt assembly and disassembly, perfectly compatible also with all 522 HD One-Track belt versions (See next page).



Article Nr. **29971**

Movex tools are made with 3D printer, the color may vary due to availability of the material.

NEW 522 HD FT One track Belt

Tappeto Modulare 522 HD, H=8,7
Modular Belt Series 522 HD, H=8,7 / Modulare Mattenkette 522 HD, H=8,7

CODE STRUCTURE GUIDE (Example)

Backflex radius min.: 10 mm

5271	01	9115	A
Series	*Material	Width	Version

pg. 313-314
 274/278/281
 pg. 651⇒661
 SAMPLE BOX
 Art.-Nr. **5271018888A**

*Material

Easy Delivery

LFA - Code 01
Low friction Acetal

MX - Code 03
Performance PBT

PFX - Code 30
Extra performance PBT

Max w. load: See table below
 Weight: 7,8 kg/m²
 Temp. range dry: -40÷80 °C
 Temp. range wet: -40÷65 °C
 Pin material: PBT white

Max w. load: See table below
 Weight: 7,5 kg/m²
 Temp. range dry: -40÷120 °C
 Temp. range wet: -40÷60 °C
 Pin material: POM black

Max w. load: See table below
 Weight: 7,5 kg/m²
 Temp. range dry: -40÷120 °C
 Temp. range wet: -40÷60 °C
 Pin material: POM black



Pin Sphere®
AUTOLOCK

- Easier installation
- Quicker maintenance
- High strength

Metric Size

12.7 mm
PITCH

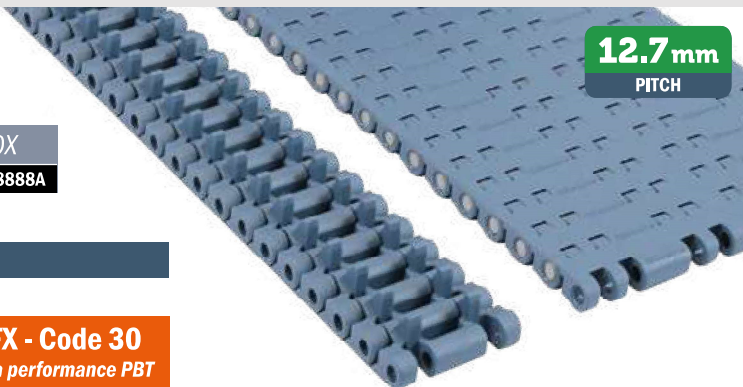

Width 29 mm

Version C - With 2 Positioner

Version A - Standard

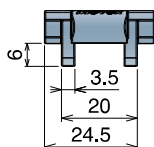
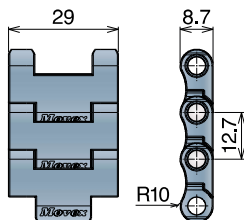

Series	Material	Width	Version
5271	*	9115	A
5271	*	9115	C

Width 34 mm

Version C - With 2 Positioner

Version A - Standard

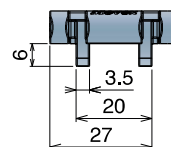
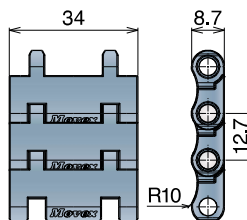

Series	Material	Width	Version
5271	*	9134	A
5271	*	9134	C

Width 37 mm

Version C - With 2 Positioner

Version A - Standard

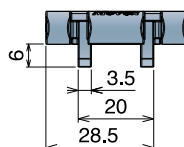
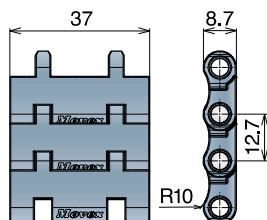

Series	Material	Width	Version
5271	*	9145	A
5271	*	9145	C

Width 51 mm

Version C - With 2 Positioner

Version A - Standard

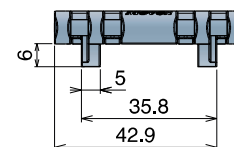
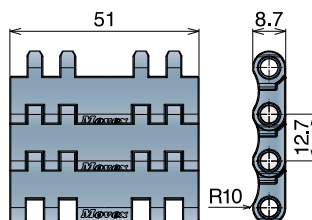

Series	Material	Width	Version
5271	*	9200	A
5271	*	9200	C

Width 76 mm

Version C - With 2 Positioner

Version A - Standard

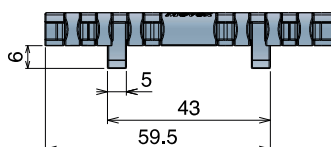
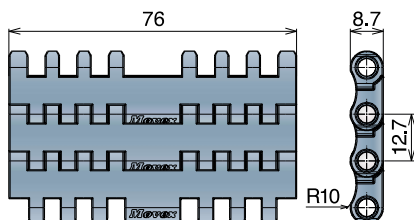

Series	Material	Width	Version
5271	*	9300	A
5271	*	9300	C

Max working load (N)

Width	29	34	37	51	76
LFA	600	870	945	1300	2000
MX	450	680	740	1020	1520
PFX	450	680	740	1020	1520

590 Series

590

Pitch 19,05 mm
H= 8,7 mm



Movex®

590 FT
590 FT *One track Belt*
590 FTT



590 FT

Tappeto Modulare 590 FT, H=8,7 M=3"
 Modular Belt Series 590 FT, H=8,7 M=3" / Modulare Mattenkette 590 FT, H=8,7 M=3"

CODE STRUCTURE GUIDE (Example)

Backflex radius min.: 25 mm

5301	01	0003	A
Series	*Material	Width	Version

	
pg. 318	pg. 651>661

SAMPLE BOX

Art.-Nr. **5301018888A**

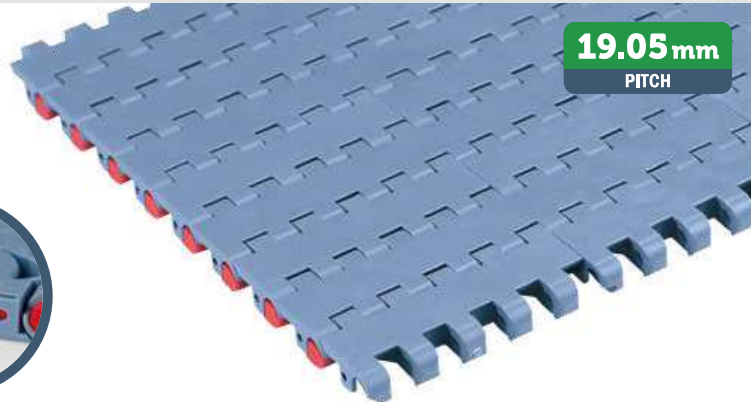
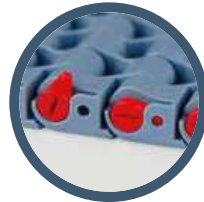

Imperial Size

* Material

LFA - Code 01

Low friction Acetal

Easy Delivery

Max w. load: 30000 N/m
 Weight: 7,2 kg/m²
 Temp. range dry: -40+80 °C
 Temp. range wet: -40+65 °C
 Pin material: PBT white

MX - Code 03

Performance PBT

Max w. load: 24000 N/m
 Weight: 7,0 kg/m²
 Temp. range dry: -40+120 °C
 Temp. range wet: -40+60 °C
 Pin material: POM grey

MPX - Code 25

Lubricated Acetal

Max w. load: 30000 N/m
 Weight: 7,2 kg/m²
 Temp. range dry: -40+80 °C
 Temp. range wet: -40+65 °C
 Pin material: PBT white

Version A - Standard

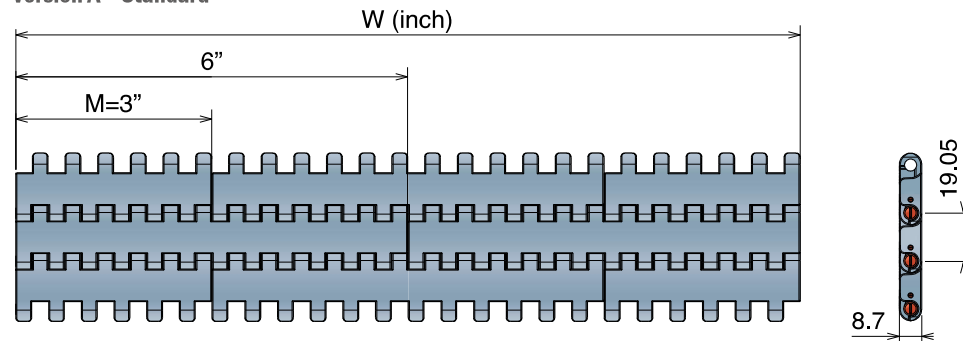

Version C - With 2 Positioner

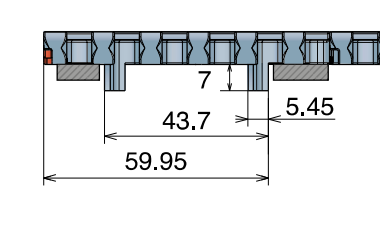

Version A - Standard

Series	Material	Width	Version
5301	*	0003	A
5301	*	0006	A
5301	*	0009	A
5301	*	0012	A
5301	*	0015	A
5301	*	0018	A
5301	*	0021	A
5301	*	0024	A
5301	*	0027	A
5301	*	0030	A
5301	*	0033	A
5301	*	0036	A
5301	*	0039	A
5301	*	0042	A
5301	*	0045	A
5301	*	0048	A
5301	*	0051	A
5301	*	0054	A

Version C - With 2 Positioners

Series	Material	Width	Version
5301	*	0003	C
5301	*	0006	C
5301	*	0009	C
5301	*	0012	C
5301	*	0015	C
5301	*	0018	C
5301	*	0021	C
5301	*	0024	C
5301	*	0027	C
5301	*	0030	C
5301	*	0033	C
5301	*	0036	C
5301	*	0039	C
5301	*	0042	C
5301	*	0045	C
5301	*	0048	C
5301	*	0051	C
5301	*	0054	C

590 FT One track Belt

Tappeti modulari / Modular belts / Mattenketten

590 FT One track Belt



Tappeto Modulare 590 FT, H=8,7
Modular Belt Series 590 FT, H=8,7 / Modulare Mattenkette 590 FT, H=8,7

CODE STRUCTURE GUIDE (Example)

Backflex radius min.: 25 mm

5301	01	9325	A
Series	*Material	Width	Version

19.05 mm
PITCH

	
pg. 318	pg. 651->661

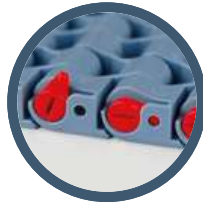
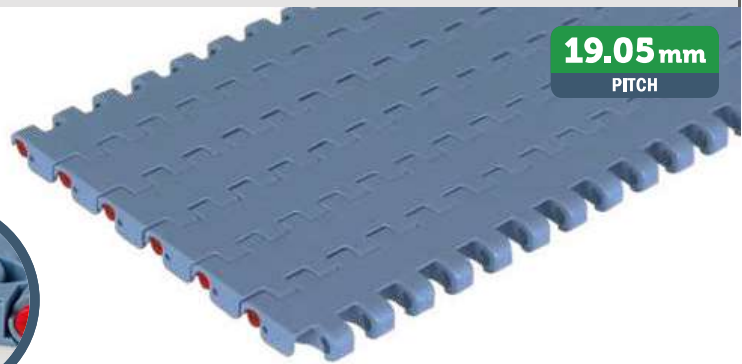

Imperial Size

*Material

LFA - Code 01
Low friction Acetal

Easy Delivery

Weight: 7,2 kg/m²
Temp. range dry: -40+80 °C
Temp. range wet: -40+65 °C
Pin material: PBT white

MX - Code 03
Performance PBT

Weight: 7,0 kg/m²
Temp. range dry: -40+120 °C
Temp. range wet: -40+60 °C
Pin material: POM grey

MPX - Code 25
Lubricated Acetal

Weight: 7,2 kg/m²
Temp. range dry: -40+80 °C
Temp. range wet: -40+65 °C
Pin material: PBT white

Max working load (N)

Width	K325	K450	K750
LFA	2500	3400	5700
MX	2000	2800	4500
MPX	2500	3400	5700

Version A - Standard

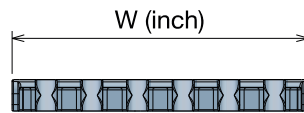

Version C - With 2 Positioner

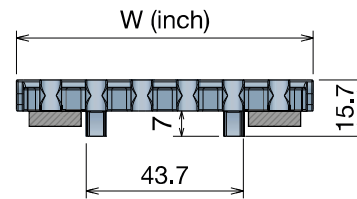

K325 - One track belt

Series	Material	Width	Version
5301	*	9325	A
5301	*	9325	C



K450 - One track belt

Series	Material	Width	Version
5301	*	9450	A
5301	*	9450	C



K750 - One track belt

Series	Material	Width	Version
5301	*	9750	A
5301	*	9750	C

Tappeti modulari / Modular belts / Mattenketten

590 FTT



Tappeto Modulare 590 FTT, H=8,7
 Modular Belt Series 590 FTT, H=8,7 / Modulare Mattenkette 590 FTT, H=8,7

CODE STRUCTURE GUIDE (Example)

Backflex radius min.: 25 mm

5306	01	9450	C-R
Series	*Material	Width	Version

19.05 mm
PITCH

	
pg. 318	pg. 651>661

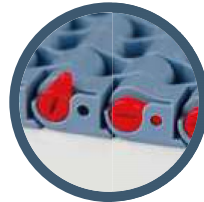

Imperial Size

* Material

LFA - Code 01

Low friction Acetal

Weight: 7,2 kg/m²
 Temp. range dry: -40+80 °C
 Temp. range wet: -40+65 °C
 Pin material: PBT white

MX - Code 03

Performance PBT

Weight: 7,0 kg/m²
 Temp. range dry: -40+120 °C
 Temp. range wet: -40+60 °C
 Pin material: POM grey

MPX - Code 25

Lubricated Acetal

Weight: 7,2 kg/m²
 Temp. range dry: -40+80 °C
 Temp. range wet: -40+65 °C
 Pin material: PBT white

Max working load (N)

Width	K450	K750
LFA	3400	5700
MX	2800	4500
MPX	3400	5700

Version 590 FTT DX

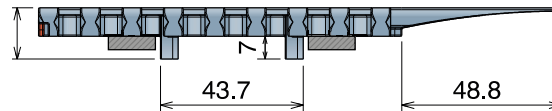

W(inch)

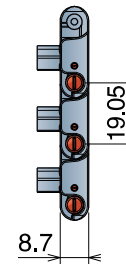
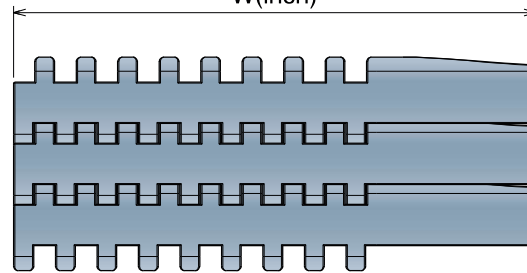

Version 590 FTT SX

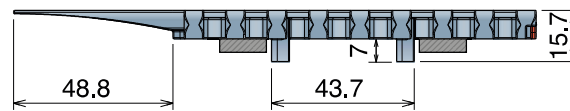

W(inch)

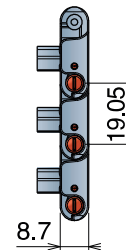
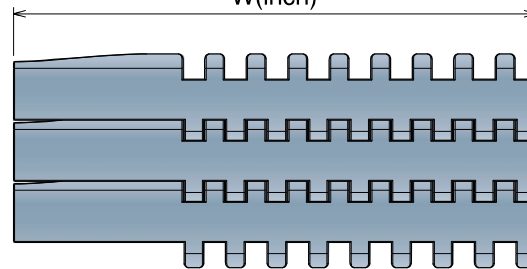

Version 590 FTT DX

Series	Material	Width	Version	Total width
5306	*	9450	C-R	160.0
5306	*	9750	C-R	236.2

Version 590 FTT SX

Series	Material	Width	Version	Total width
5306	*	9450	C-L	160.0
5306	*	9750	C-L	236.2

525

Pitch 15,0 mm
H= 8,7 mm

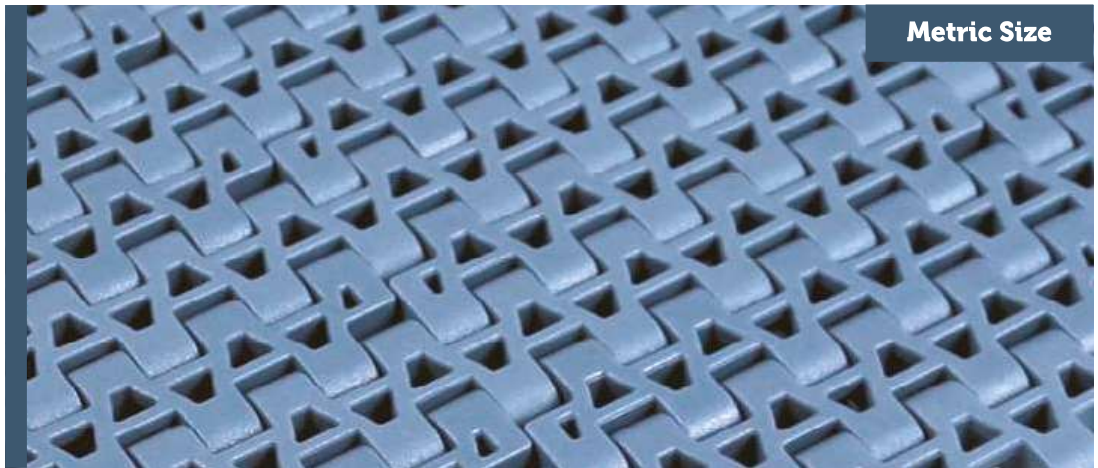

Metric Size

- 525 HD FT
- 525 HD FT+RIB
- 525 FTT
- 525 HD FG
- 525 HD GT
- 525 HD GT *Side Indent*

525 HD FT

Tappeto Modulare 525 HD, H=8,7 M=85
Modular Belt Series 525 HD, H=8,7 M=85 / Modulare Mattenkette 525 HD, H=8,7 M=85

CODE STRUCTURE GUIDE (Example)

5261	01	0085	A
Series	*Material	Width	Version

Backflex radius min.: 25 mm

15.0 mm
PITCH

pg. 317	273/277/280	pg. 651→661

SAMPLE BOX

Art.-Nr. **5261018888A**



REINFORCED POSITIONER

Metric Size

* Material

LFA - Code 01

Low friction Acetal

Easy Delivery

Max w. load: 25500 N/m
Weight: 9,0 kg/m²
Temp. range dry: -40+80 °C
Temp. range wet: -40+65 °C
Pin material: PBT white

PP - Code 02

Polypropylene

Max w. load: 15500 N/m
Weight: 8,7 kg/m²
Temp. range dry: 4+104 °C
Temp. range wet: 4+104 °C
Pin material: PP blue

MX - Code 03

Performance PBT

Max w. load: 20500 N/m
Weight: 8,7 kg/m²
Temp. range dry: -40+120 °C
Temp. range wet: -40+60 °C
Pin material: POM grey

LFB - Code 23

Low friction Acetal

Max w. load: 25500 N/m
Weight: 9,0 kg/m²
Temp. range dry: -40+80 °C
Temp. range wet: -40+65 °C
Pin material: PBT white

PFX - Code 30

Extra performance PBT

Max w. load: 20500 N/m
Weight: 8,7 kg/m²
Temp. range dry: -40+120 °C
Temp. range wet: -40+60 °C
Pin material: POM grey

**THE BEST CHOICE FOR
DRY RUNNING APPLICATIONS**

Version A - Standard

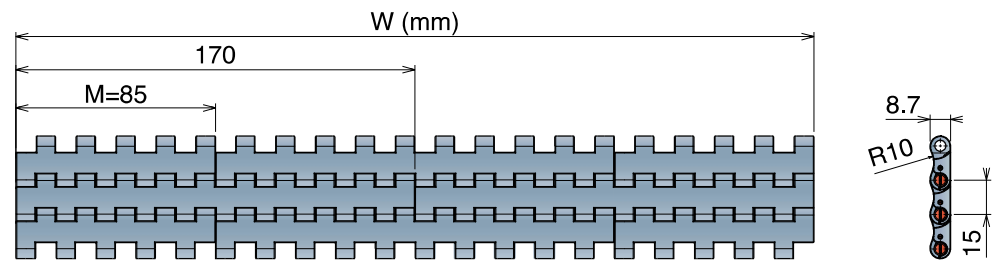

Version B - With 1 Positioner

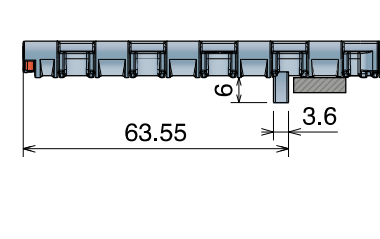

Version C - With 2 Positioner

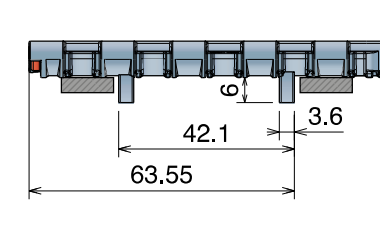

Version A - Standard

Series	Material	Width	Version
5261	*	0085	A
5261	*	0170	A
5261	*	0255	A
5261	*	0340	A
5261	*	0425	A
5261	*	0510	A
5261	*	0595	A
5261	*	0680	A
5261	*	0765	A
5261	*	0850	A
5261	*	0935	A
5261	*	1020	A
5261	*	1105	A
5261	*	1190	A
5261	*	1275	A
5261	*	1360	A
5261	*	1445	A
5261	*	1530	A

Version B - With 1 Positioner

Series	Material	Width	Version
5261	*	0085	B
5261	*	0170	B
5261	*	0255	B
5261	*	0340	B
5261	*	0425	B
5261	*	0510	B
5261	*	0595	B
5261	*	0680	B
5261	*	0765	B
5261	*	0850	B
5261	*	0935	B
5261	*	1020	B
5261	*	1105	B
5261	*	1190	B
5261	*	1275	B
5261	*	1360	B
5261	*	1445	B
5261	*	1530	B

Version C - With 2 Positioners

Series	Material	Width	Version
5261	*	0085	C
5261	*	0170	C
5261	*	0255	C
5261	*	0340	C
5261	*	0425	C
5261	*	0510	C
5261	*	0595	C
5261	*	0680	C
5261	*	0765	C
5261	*	0850	C
5261	*	0935	C
5261	*	1020	C
5261	*	1105	C
5261	*	1190	C
5261	*	1275	C
5261	*	1360	C
5261	*	1445	C
5261	*	1530	C



525 HD FT + RIB Tappeto Modulare 525 HD, H=8,7 M=85 Modular Belt Series 525 HD, H=8,7 M=85 / Modulare Mattenkette 525 HD, H=8,7 M=85

Metric Size

CODE STRUCTURE GUIDE (Example)

Backflex radius min.: 25 mm

5261	01	0085	A	XR3
Series	*Material	Width	Version	RIB

		
pg. 317	273/277/280	pg. 651 > 661



*Material

LFA - Code 01 Low friction Acetal

Max w. load: 25500 N/m
Weight: 9,0 kg/m²
Temp. range dry: -40÷80 °C
Temp. range wet: -40÷65 °C
Pin material: PBT white

MX - Code 03 Performance PBT

Max w. load: 20500 N/m
Weight: 8,7 kg/m²
Temp. range dry: -40÷120 °C
Temp. range wet: -40÷60 °C
Pin material: POM grey

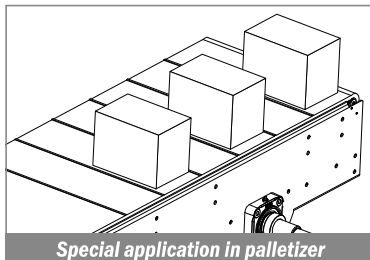

Version A - Standard

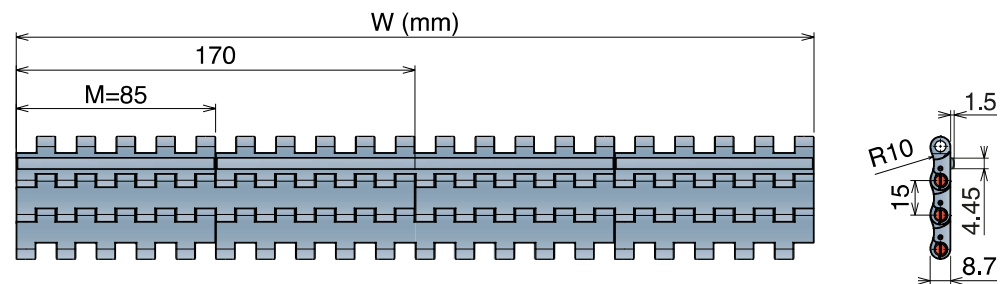

Version B - With 1 Positioner

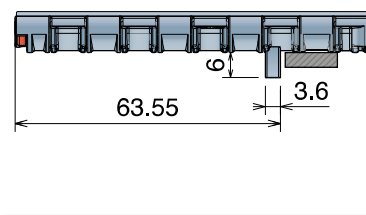

Version C - With 2 Positioners

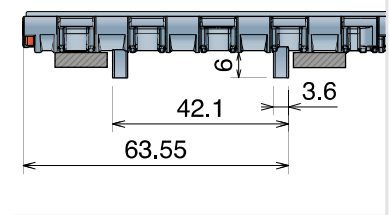

Version A - Standard

Series	Material	Width	Version	RIB
5261	*	0085	A	XR3 or XR5
5261	*	0170	A	XR3 or XR5
5261	*	0255	A	XR3 or XR5
5261	*	0340	A	XR3 or XR5
5261	*	0425	A	XR3 or XR5
5261	*	0510	A	XR3 or XR5
5261	*	0595	A	XR3 or XR5
5261	*	0680	A	XR3 or XR5
5261	*	0765	A	XR3 or XR5
5261	*	0850	A	XR3 or XR5
5261	*	0935	A	XR3 or XR5
5261	*	1020	A	XR3 or XR5
5261	*	1105	A	XR3 or XR5
5261	*	1190	A	XR3 or XR5
5261	*	1275	A	XR3 or XR5
5261	*	1360	A	XR3 or XR5
5261	*	1445	A	XR3 or XR5
5261	*	1530	A	XR3 or XR5

XR3 (RIB every 3 links) | XR5 (RIB every 5 links)

Version B - With 1 Positioner

Series	Material	Width	Version	RIB
5261	*	0085	B	XR3 or XR5
5261	*	0170	B	XR3 or XR5
5261	*	0255	B	XR3 or XR5
5261	*	0340	B	XR3 or XR5
5261	*	0425	B	XR3 or XR5
5261	*	0510	B	XR3 or XR5
5261	*	0595	B	XR3 or XR5
5261	*	0680	B	XR3 or XR5
5261	*	0765	B	XR3 or XR5
5261	*	0850	B	XR3 or XR5
5261	*	0935	B	XR3 or XR5
5261	*	1020	B	XR3 or XR5
5261	*	1105	B	XR3 or XR5
5261	*	1190	B	XR3 or XR5
5261	*	1275	B	XR3 or XR5
5261	*	1360	B	XR3 or XR5
5261	*	1445	B	XR3 or XR5
5261	*	1530	B	XR3 or XR5

XR3 (RIB every 3 links) | XR5 (RIB every 5 links)

Version C - With 2 Positioners

Series	Material	Width	Version	RIB
5261	*	0085	C	XR3 or XR5
5261	*	0170	C	XR3 or XR5
5261	*	0255	C	XR3 or XR5
5261	*	0340	C	XR3 or XR5
5261	*	0425	C	XR3 or XR5
5261	*	0510	C	XR3 or XR5
5261	*	0595	C	XR3 or XR5
5261	*	0680	C	XR3 or XR5
5261	*	0765	C	XR3 or XR5
5261	*	0850	C	XR3 or XR5
5261	*	0935	C	XR3 or XR5
5261	*	1020	C	XR3 or XR5
5261	*	1105	C	XR3 or XR5
5261	*	1190	C	XR3 or XR5
5261	*	1275	C	XR3 or XR5
5261	*	1360	C	XR3 or XR5
5261	*	1445	C	XR3 or XR5
5261	*	1530	C	XR3 or XR5

XR3 (RIB every 3 links) | XR5 (RIB every 5 links)



525 FTT

Tappeto Modulare 525 FTT, H=8,7 M=85
 Modular Belt Series 525 FTT, H=8,7 M=85 / Modulare Mattenkette 525 FTT, H=8,7 M=85

CODE STRUCTURE GUIDE (Example)

Backflex radius min.: 25 mm

5256	01	0085	C
Series	*Material	Width	Version

		
pg. 317	273/277/280	pg. 651⇒661

*Material

LFA - Code 01 Low friction Acetal	MX - Code 03 Performance PBT
---	--

Max w. load: 21500 N/m	Max w. load: 17500 N/m
Weight: 7,8 kg/m ²	Weight: 7,5 kg/m ²
Temp. range dry: -40÷80 °C	Temp. range dry: -40÷120 °C
Temp. range wet: -40÷65 °C	Temp. range wet: -40÷60 °C
Pin material: PBT white	Pin material: POM grey

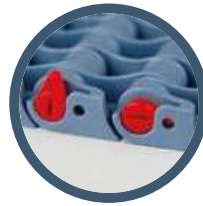

15.0 mm
PITCH

Metric Size

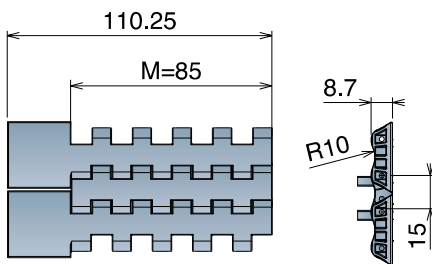

Version C

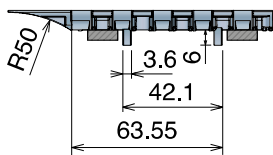

Version C

Series	Material	Width	Version
5256	*	0085	C

Max working load (N)

Width	85
LFA	1850
MX	1500

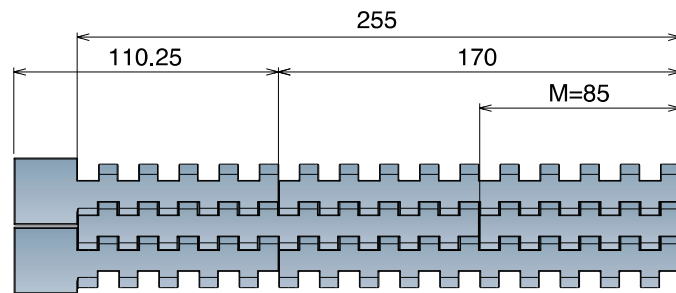

Version CN - Near



Version CO - Opposite



Version CN - Near

Series	Material	Width	Version
5256	*	0170	CN
5256	*	0255	CN

Version CO - Opposite

Series	Material	Width	Version
5256	*	0170	CO
5256	*	0255	CO

525 HD FG Open Surface 35% Tappeto Modulare 525 HD Flush grid, H=8,7 M=85 Modular Belt Series 525 HD Flush grid, H=8,7 M=85 / Modulare Mattenkette 525 HD Flush grid, H=8,7 M=85

CODE STRUCTURE GUIDE (Example)

Backflex radius min.: 25 mm

5262	01	0085	A
Series	*Material	Width	Version

pg. 317	273/277/280	pg. 651>661

SAMPLE BOX	
Art.-Nr.	5262018888A

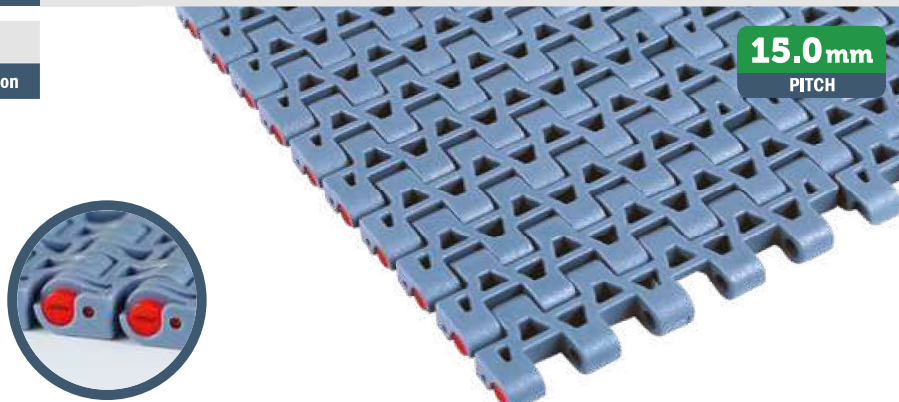

15.0 mm
PITCH



Metric Size

*Material

LFA - Code 01

Low friction Acetal

Easy Delivery

Max w. load: 25500 N/m
Weight: 8,1 kg/m²
Temp. range dry: -40+80 °C
Temp. range wet: -40+65 °C
Pin material: PBT white

MX - Code 03

Performance PBT

Max w. load: 20500 N/m
Weight: 7,8 kg/m²
Temp. range dry: -40+120 °C
Temp. range wet: -40+60 °C
Pin material: POM grey

LFB - Code 23

Low friction Acetal

Max w. load: 25500 N/m
Weight: 8,1 kg/m²
Temp. range dry: -40+80 °C
Temp. range wet: -40+65 °C
Pin material: PBT white

PFX - Code 30

Extra performance PBT

Max w. load: 20500 N/m
Weight: 7,8 kg/m²
Temp. range dry: -40+120 °C
Temp. range wet: -40+60 °C
Pin material: POM grey

**THE BEST CHOICE FOR
DRY RUNNING APPLICATIONS**

Version A - Standard

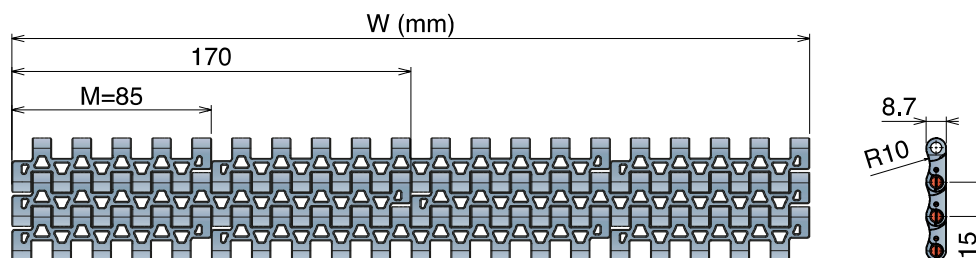

Version B - With 1 Positioner

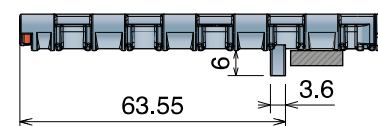

Version C - With 2 Positioner

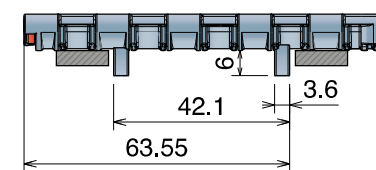

Version A - Standard

Series	Material	Width	Version
5262	*	0085	A
5262	*	0170	A
5262	*	0255	A
5262	*	0340	A
5262	*	0425	A
5262	*	0510	A
5262	*	0595	A
5262	*	0680	A
5262	*	0765	A
5262	*	0850	A
5262	*	0935	A
5262	*	1020	A
5262	*	1105	A
5262	*	1190	A
5262	*	1275	A
5262	*	1360	A
5262	*	1445	A
5262	*	1530	A

Version B - With 1 Positioner

Series	Material	Width	Version
5262	*	0085	B
5262	*	0170	B
5262	*	0255	B
5262	*	0340	B
5262	*	0425	B
5262	*	0510	B
5262	*	0595	B
5262	*	0680	B
5262	*	0765	B
5262	*	0850	B
5262	*	0935	B
5262	*	1020	B
5262	*	1105	B
5262	*	1190	B
5262	*	1275	B
5262	*	1360	B
5262	*	1445	B
5262	*	1530	B

Version C - With 2 Positioners

Series	Material	Width	Version
5262	*	0085	C
5262	*	0170	C
5262	*	0255	C
5262	*	0340	C
5262	*	0425	C
5262	*	0510	C
5262	*	0595	C
5262	*	0680	C
5262	*	0765	C
5262	*	0850	C
5262	*	0935	C
5262	*	1020	C
5262	*	1105	C
5262	*	1190	C
5262	*	1275	C
5262	*	1360	C
5262	*	1445	C
5262	*	1530	C

525 HD GT

Tappeto Modulare 525 HD GT, H=8,7 M=85
Modular Belt Series 525 HD GT, H=8,7 M=85 / Modulare Mattenkette 525 HD GT, H=8,7 M=85

CODE STRUCTURE GUIDE (Example)

Backflex radius min.: 25 mm

5263	01	0085	A
Series	*Material	Width	Version

pg. 317	273/277/280	pg. 651→661

SAMPLE BOX

Art.-Nr. **5263018888A**

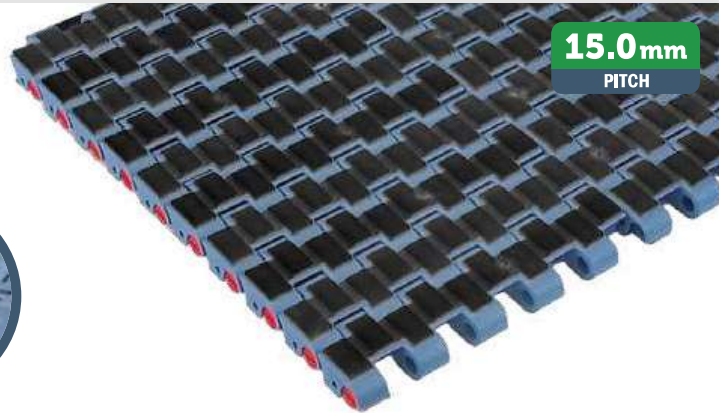

15.0 mm
PITCH

Metric Size

* Material

LFA - Code 01

Low friction Acetal

Easy Delivery

Max w. load: 25500 N/m
Weight: 10,35 kg/m²
Temp. range dry: -40+80 °C
Temp. range wet: -40+65 °C
Pin material: PBT white
Top rubber: 50 ShA- Dark grey

PP - Code 02

Polypropylene

Max w. load: 15500 N/m
Weight: 8,7 kg/m²
Temp. range dry: 4+80 °C
Temp. range wet: 4+80 °C
Pin material: PP blue
Top rubber: 50 ShA- Pigeon blue

MX - Code 03

Performance PBT

Max w. load: 20500 N/m
Weight: 10,35 kg/m²
Temp. range dry: -40+120 °C
Temp. range wet: -40+60 °C
Pin material: POM grey
Top rubber: 50 ShA- Dark grey

Version A - Standard

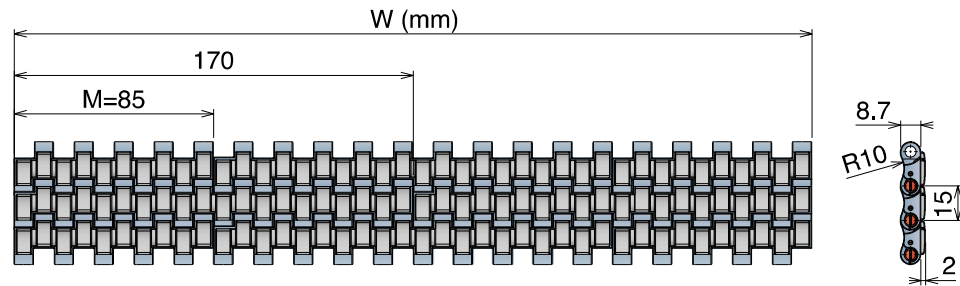

Version B - With 1 Positioner

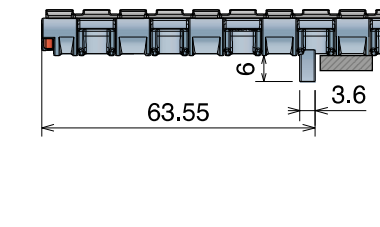

Version C - With 2 Positioner

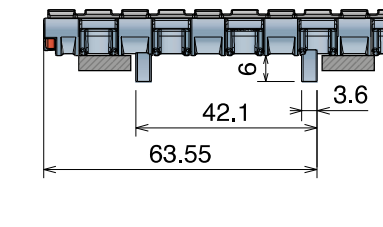

Version A - Standard

Series	Material	Width	Version
5263	*	0085	A
5263	*	0170	A
5263	*	0255	A
5263	*	0340	A
5263	*	0425	A
5263	*	0510	A
5263	*	0595	A
5263	*	0680	A
5263	*	0765	A
5263	*	0850	A
5263	*	0935	A
5263	*	1020	A
5263	*	1105	A
5263	*	1190	A
5263	*	1275	A
5263	*	1360	A
5263	*	1445	A
5263	*	1530	A

Version B - With 1 Positioner

Series	Material	Width	Version
5263	*	0085	B
5263	*	0170	B
5263	*	0255	B
5263	*	0340	B
5263	*	0425	B
5263	*	0510	B
5263	*	0595	B
5263	*	0680	B
5263	*	0765	B
5263	*	0850	B
5263	*	0935	B
5263	*	1020	B
5263	*	1105	B
5263	*	1190	B
5263	*	1275	B
5263	*	1360	B
5263	*	1445	B
5263	*	1530	B

Version C - With 2 Positioners

Series	Material	Width	Version
5263	*	0085	C
5263	*	0170	C
5263	*	0255	C
5263	*	0340	C
5263	*	0425	C
5263	*	0510	C
5263	*	0595	C
5263	*	0680	C
5263	*	0765	C
5263	*	0850	C
5263	*	0935	C
5263	*	1020	C
5263	*	1105	C
5263	*	1190	C
5263	*	1275	C
5263	*	1360	C
5263	*	1445	C
5263	*	1530	C

525 HD GT Side indent

Tappeti modulari / Modular belts / Mattenketten

Belts wider than standard are available with 85 mm increments

525 HD GT Side Indent

Tappeto Modulare 525 HD GT Side Indent, H=8,7 M=85
Modular Belt Series 525 HD GT Side Indent, H=8,7 M=85 / Modulare Mattenkette 525 HD GT Side Indent, H=8,7 M=85

Metric Size

CODE STRUCTURE GUIDE (Example)

Backflex radius min.: 25 mm

5265	01	0255	A
Series	*Material	Width	Version

pg. 317	273/277/280	pg. 651>661

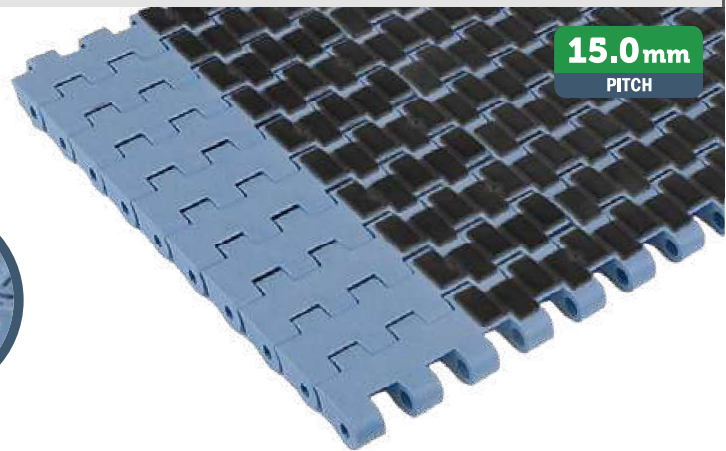

*Material

LFA - Code 01
Low friction Acetal

Easy Delivery

Max w. load: 25500 N/m
Weight: 10,35 kg/m²
Temp. range dry: -40+80 °C
Temp. range wet: -40+65 °C
Pin material: PBT white
Top rubber: 50 ShA- Dark grey

PP - Code 02
Polypropylene

Max w. load: 15500 N/m
Weight: 8,7 kg/m²
Temp. range dry: 4+80 °C
Temp. range wet: 4+80 °C
Pin material: PP blue
Top rubber: 50 ShA- Pigeon blue

MX - Code 03
Performance PBT

Max w. load: 20500 N/m
Weight: 10,35 kg/m²
Temp. range dry: -40+120 °C
Temp. range wet: -40+60 °C
Pin material: POM grey
Top rubber: 50 ShA- Dark grey

Version A - Standard

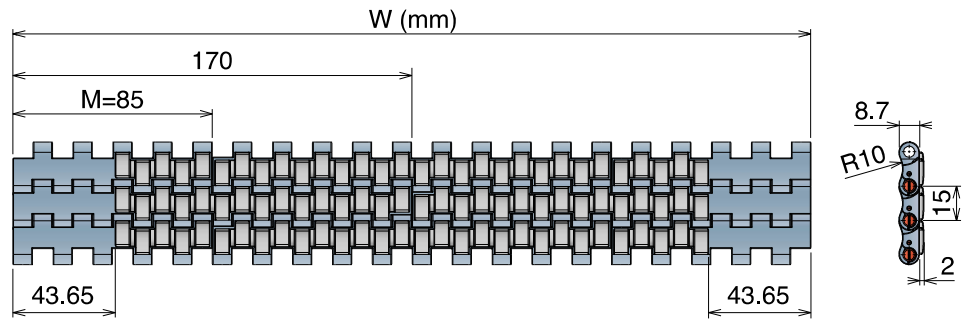

Version B - With 1 Positioner

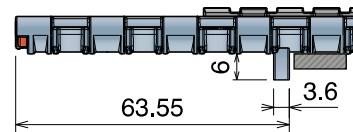

Version C - With 2 Positioner

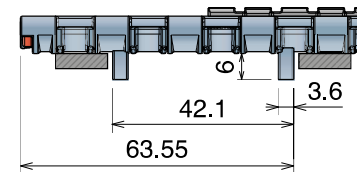

Version A - Standard

Series	Material	Width	Version
5265	*	0255	A
5265	*	0340	A
5265	*	0425	A
5265	*	0510	A
5265	*	0595	A
5265	*	0680	A
5265	*	0765	A
5265	*	0850	A
5265	*	0935	A
5265	*	1020	A
5265	*	1105	A
5265	*	1190	A
5265	*	1275	A
5265	*	1360	A
5265	*	1445	A
5265	*	1530	A

Version B - With 1 Positioner

Series	Material	Width	Version
5265	*	0255	B
5265	*	0340	B
5265	*	0425	B
5265	*	0510	B
5265	*	0595	B
5265	*	0680	B
5265	*	0765	B
5265	*	0850	B
5265	*	0935	B
5265	*	1020	B
5265	*	1105	B
5265	*	1190	B
5265	*	1275	B
5265	*	1360	B
5265	*	1445	B
5265	*	1530	B

Version C - With 2 Positioners

Series	Material	Width	Version
5265	*	0255	C
5265	*	0340	C
5265	*	0425	C
5265	*	0510	C
5265	*	0595	C
5265	*	0680	C
5265	*	0765	C
5265	*	0850	C
5265	*	0935	C
5265	*	1020	C
5265	*	1105	C
5265	*	1190	C
5265	*	1275	C
5265	*	1360	C
5265	*	1445	C
5265	*	1530	C

Tappeti modulari / Modular belts / Mattenketten

530

Pitch 15,0 mm
H= 8,7 mm



530 FT
530 FTT
530 GT
530 GT *Side indent*
530 LBP
530 PRO LBP



530 FT

Tappeto Modulare 530 FT, H=8,7 M=3"
 Modular Belt Series 530 FT, H=8,7 M=3" / Modulare Mattenkette 530 FT, H=8,7 M=3"

CODE STRUCTURE GUIDE (Example)

Backflex radius min.: 25 mm

5321	01	0003	A
Series	*Material	Width	Version

		
pg. 317	275/278/281	pg. 651>661

SAMPLE BOX	
Art.-Nr.	5321018888A

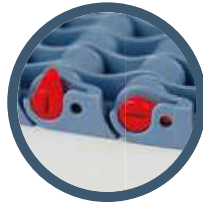

15.0 mm
PITCH

Imperial Size

*Material

LFA - Code 01
Low friction Acetal

Easy Delivery

Max w. load: 26000 N/m
 Weight: 9,2 kg/m²
 Temp. range dry: -40+80 °C
 Temp. range wet: -40+65 °C
 Pin material: PBT white

MX - Code 03
Performance PBT

Max w. load: 21000 N/m
 Weight: 9,0 kg/m²
 Temp. range dry: -40+120 °C
 Temp. range wet: -40+60 °C
 Pin material: POM grey

DKM - Code 16
Aramide Reinforced Acetal

Max w. load: 26000 N/m
 Weight: 9,2 kg/m²
 Temp. range dry: -40+80 °C
 Temp. range wet: -40+65 °C
 Pin material: PBT white

MWX - Code 17
Polyamide Composite

Max w. load: 26000 N/m
 Weight: 9,5 kg/m²
 Temp. range dry: -40+104 °C
 Temp. range wet: NR
 Pin material: PBT white

MPX - Code 25
Lubricated Acetal

Max w. load: 26000 N/m
 Weight: 9,2 kg/m²
 Temp. range dry: -40+80 °C
 Temp. range wet: -40+65 °C
 Pin material: PBT white

Version A - Standard

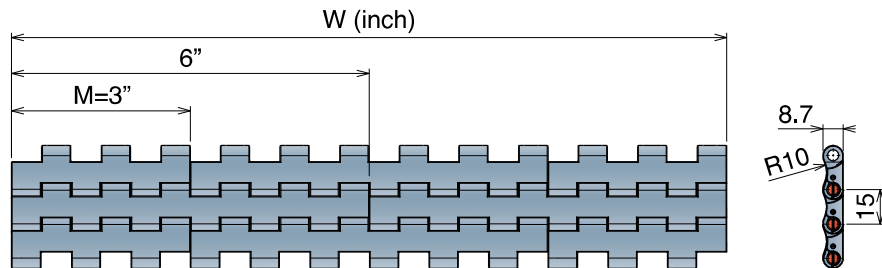

Version A - Standard

Series	Material	Width	Version
5321	*	0003	A
5321	*	0006	A
5321	*	0009	A
5321	*	0012	A
5321	*	0015	A
5321	*	0018	A
5321	*	0021	A
5321	*	0024	A
5321	*	0027	A
5321	*	0030	A
5321	*	0033	A
5321	*	0036	A
5321	*	0039	A
5321	*	0042	A
5321	*	0045	A
5321	*	0048	A
5321	*	0051	A
5321	*	0054	A



530 FTT

Tappeto Modulare 530 FTT, H=8,7 M=3"
 Modular Belt Series 530 FTT, H=8,7 M=3" / Modulare Mattenkette 530 FTT, H=8,7 M=3"

CODE STRUCTURE GUIDE (Example)

Backflex radius min.: 25 mm

5326	01	0003	A
Series	*Material	Width	Version

		
pg. 317	275/278/281	pg. 651⇒661

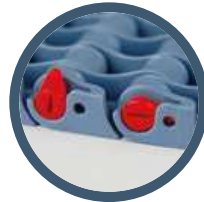

15.0 mm
PITCH

Imperial Size

* Material

LFA - Code 01

Low friction Acetal

Max w. load: 26000 N/m
 Weight: 9,2 kg/m²
 Temp. range dry: -40+80 °C
 Temp. range wet: -40+65 °C
 Pin material: PBT white

MX - Code 03

Performance PBT

Max w. load: 21000 N/m
 Weight: 9,0 kg/m²
 Temp. range dry: -40+120 °C
 Temp. range wet: -40+60 °C
 Pin material: POM grey

Version A - Standard

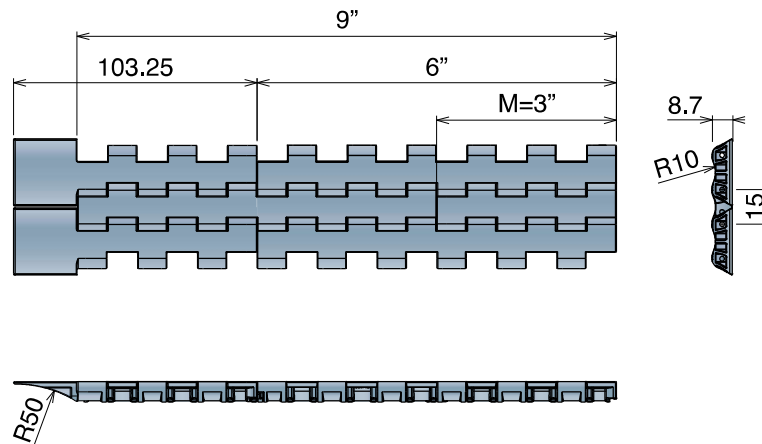

Version A - Standard

Series	Material	Width	Version
5326	*	0003	A
5326	*	0006	A
5326	*	0009	A





530 GT

Tappeto Modulare 530 GT, H=8,7 M=3"
Modular Belt Series 530 GT, H=8,7 M=3" / Modulare Mattenkette 530 GT, H=8,7 M=3"

CODE STRUCTURE GUIDE (Example)

Backflex radius min.: 30 mm

5323	01	0003	A
Series	*Material	Width	Version

		
pg. 317	275/278/281	pg. 651>661

SAMPLE BOX	
Art.-Nr.	5323018888A

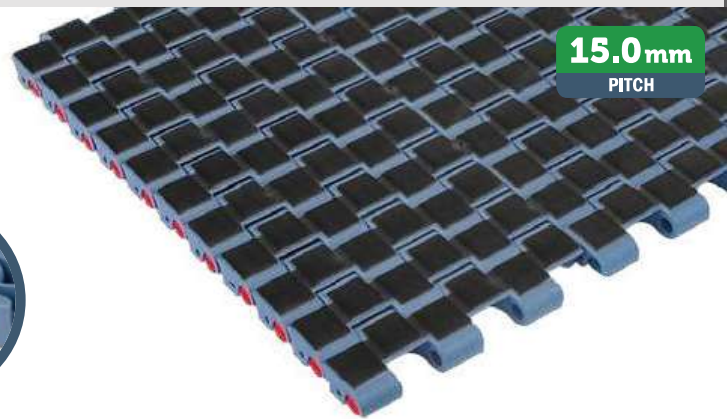
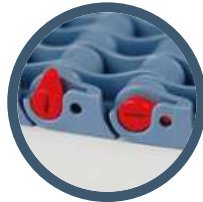

15.0 mm
PITCH

Imperial Size

*Material

LFA - Code 01
Low friction Acetal

Easy Delivery

Max w. load: 26000 N/m
Weight: 10,6 kg/m²
Temp. range dry: -40+80 °C
Temp. range wet: -40+65 °C
Pin material: PBT white
Top rubber: 50 ShA-Dark grey

PP - Code 02
Polypropylene

Max w. load: 16000 N/m
Weight: 9,0 kg/m²
Temp. range dry: 4+80 °C
Temp. range wet: 4+80 °C
Pin material: PP blue
Top rubber: 50 ShA-Pigeon blue

MX - Code 03
Performance PBT

Max w. load: 21000 N/m
Weight: 10,6 kg/m²
Temp. range dry: -40+120 °C
Temp. range wet: -40+60 °C
Pin material: POM grey
Top rubber: 50 ShA-Dark grey

Version A - Standard

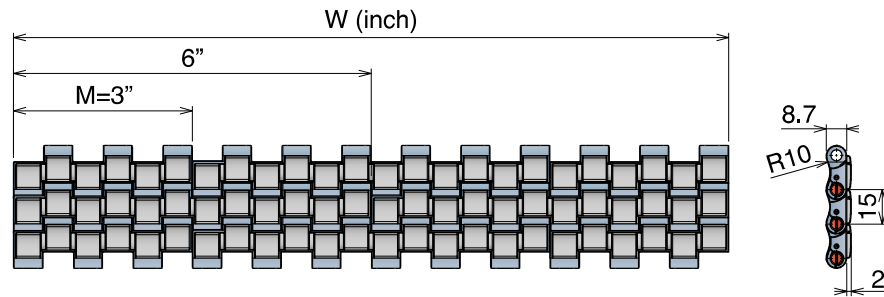

Version A - Standard

Series	Material	Width	Version
5323	*	0003	A
5323	*	0006	A
5323	*	0009	A
5323	*	0012	A
5323	*	0015	A
5323	*	0018	A
5323	*	0021	A
5323	*	0024	A
5323	*	0027	A
5323	*	0030	A
5323	*	0033	A
5323	*	0036	A
5323	*	0039	A
5323	*	0042	A
5323	*	0045	A
5323	*	0048	A
5323	*	0051	A
5323	*	0054	A



530 GT Side indent

Tappeto Modulare 530 GT, H=8,7 M=3"
Modular Belt Series 530 GT, H=8,7 M=3" / Modulare Mattenkette 530 GT, H=8,7 M=3"

CODE STRUCTURE GUIDE (Example)

Backflex radius min.: 30 mm

5325	01	0009	A
Series	*Material	Width	Version

		
pg. 317	275/278/281	pg. 651⇒661

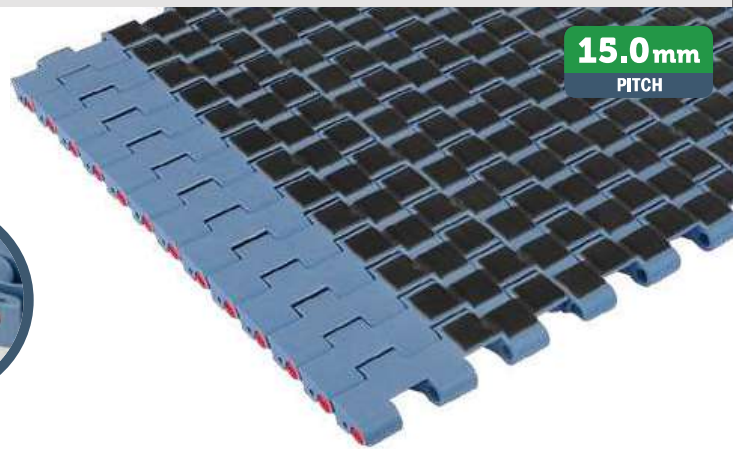
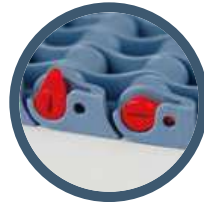

15.0 mm
PITCH

Imperial Size

* Material

LFA - Code 01

Low friction Acetal

Easy Delivery

Max w. load: 26000 N/m
Weight: 10,6 kg/m²
Temp. range dry: -40+80 °C
Temp. range wet: -40+65 °C
Pin material: PBT white
Top rubber: 50 ShA-Dark grey

PP - Code 02

Polypropylene

Max w. load: 16000 N/m
Weight: 9,0 kg/m²
Temp. range dry: 4+80 °C
Temp. range wet: 4+80 °C
Pin material: PP blue
Top rubber: 50 ShA-Pigeon blue

MX - Code 03

Performance PBT

Max w. load: 21000 N/m
Weight: 10,6 kg/m²
Temp. range dry: -40+120 °C
Temp. range wet: -40+60 °C
Pin material: POM grey
Top rubber: 50 ShA-Dark grey

Version A - Standard

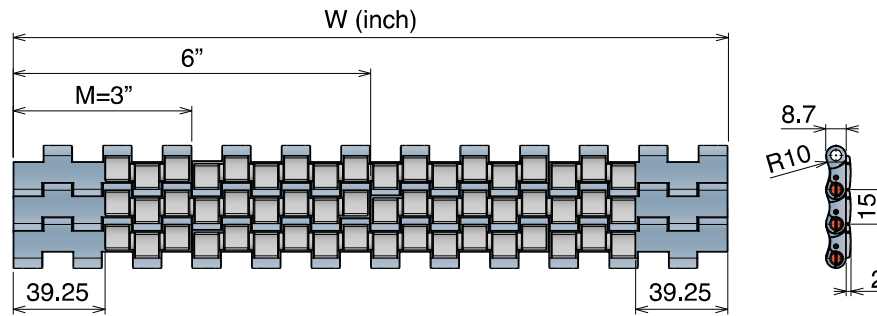

Version A - Standard

Series	Material	Width	Version
5325	*	0009	A
5325	*	0012	A
5325	*	0015	A
5325	*	0018	A
5325	*	0021	A
5325	*	0024	A
5325	*	0027	A
5325	*	0030	A
5325	*	0033	A
5325	*	0036	A
5325	*	0039	A
5325	*	0042	A
5325	*	0045	A
5325	*	0048	A
5325	*	0051	A
5325	*	0054	A

530 LBP

Tappeti modulari / Modular belts / Mattenketten

Belts wider than standard are available with 6 inch increments



530 LBP

Tappeto Modulare 530 LBP, H=8,7 M=3"
Modular Belt Series 530 LBP, H=8,7 M=3" / Modulare Mattenkette 530 LBP, H=8,7 M=3"

CODE STRUCTURE GUIDE (Example)

Backflex radius min.: 25 mm

5324	01	0006	A
Series	*Material	Width	Version

		
pg. 317	pg. 275/279	pg. 651>661

SAMPLE BOX	
Art.-Nr.	5324018888A

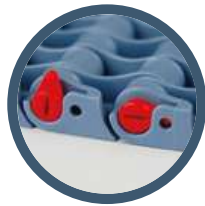
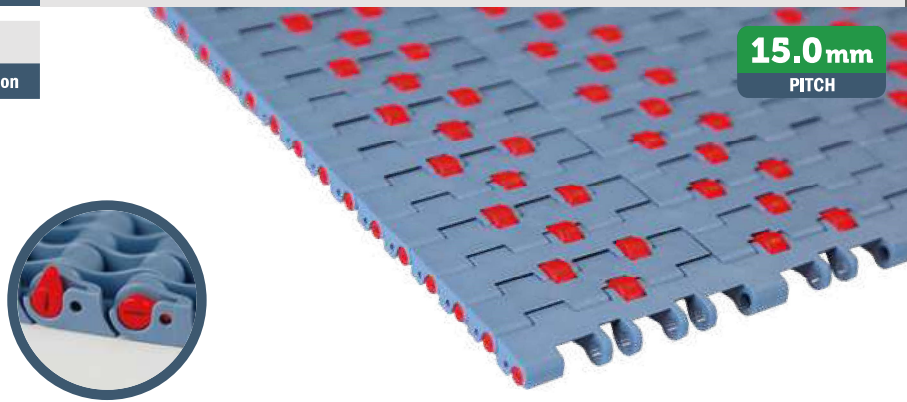

Imperial Size

Material

LFA - Code 01
Low friction Acetal

Max w. load: 24000 N/m
Weight: 9,0 kg/m²
Temp, range dry: -40+80 °C
Temp, range dry: -40+65 °C
Pin material: PBT white

POM Roller

Density: 700 rollers/m²

Version A - Standard

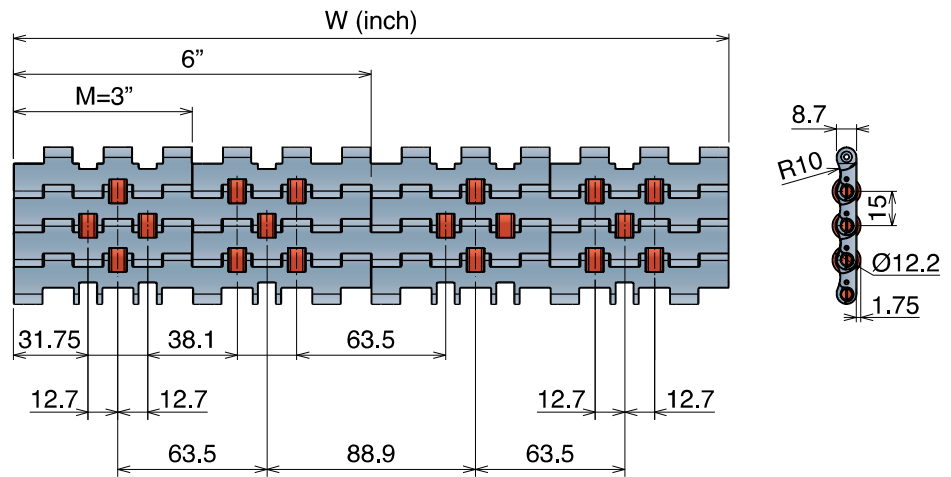

Version A - Standard

Series	Material	Width	Version
5324	01	0006	A
5324	01	0012	A
5324	01	0018	A
5324	01	0024	A
5324	01	0030	A
5324	01	0036	A
5324	01	0042	A
5324	01	0048	A
5324	01	0054	A

Guide position for accumulation system - Example

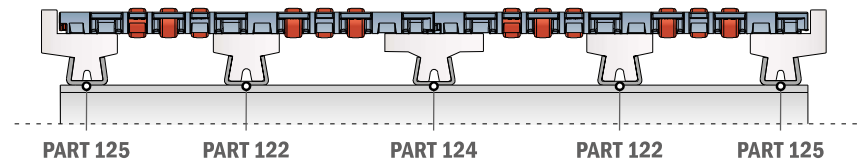

For accumulation system, please place the wear strips between the rollers (max 50 mm).

Guide position for driven rollers, for alignment/distribution system - Example

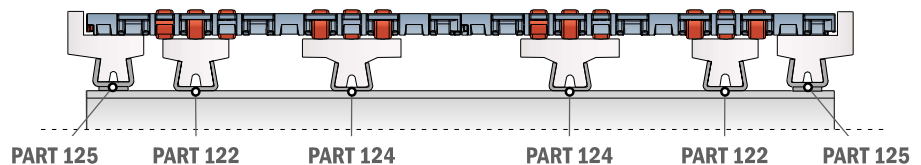

For driven rollers, please place the wear strips directly in contact under the rollers.

530 LBP can also be used with standard profiles: consult extruded profiles section for more details.

Tappeti modulari / Modular belts / Mattenketten

PATENTED

Belts wider than standard are available with 3 inch increments

530 PRO LBP

Tappeti modulari / Modular belts / Mattenketten



NEW 530 PRO LBP

Tappeto Modulare 530 PRO LBP, H=8,7 M=3"
Modular Belt Series 530 PRO LBP, H=8,7 M=3" / Modulare Mattenkette 530 PRO LBP, H=8,7 M=3"

CODE STRUCTURE GUIDE (Example)

Backflex radius min.: 25 mm

5237	01	0006	A
Series	*Material	Width	Version

		
pg. 317	pg. 276/279	pg. 651-661

SAMPLE BOX

Art.-Nr. **5237018888A**



- Easier installation
- Quicker maintenance
- High strength

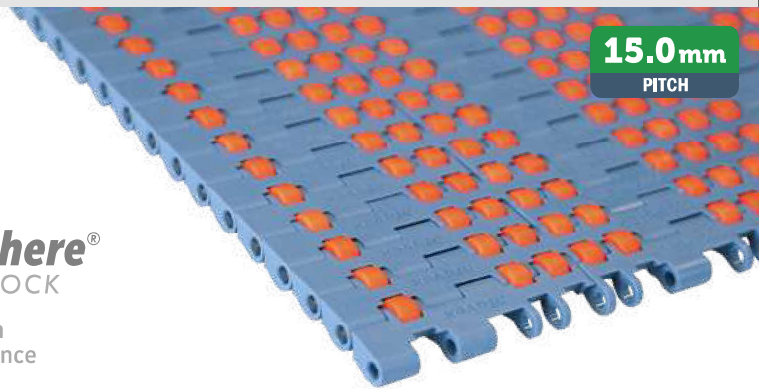

15.0 mm
PITCH

Imperial Size

Material

LFA - Code 01
Low friction Acetal

Max w. load: 21000 N/m
Weight: 10,0 kg/m²
Temp. range dry: -40÷80 °C
Temp. range wet: -40÷65 °C
Pin material: PBT white

PFX Roller

Density: 3.400 rollers/m²

**THE BEST CHOICE TO REACH
THE LOWEST FRICTION**

Version A - Standard

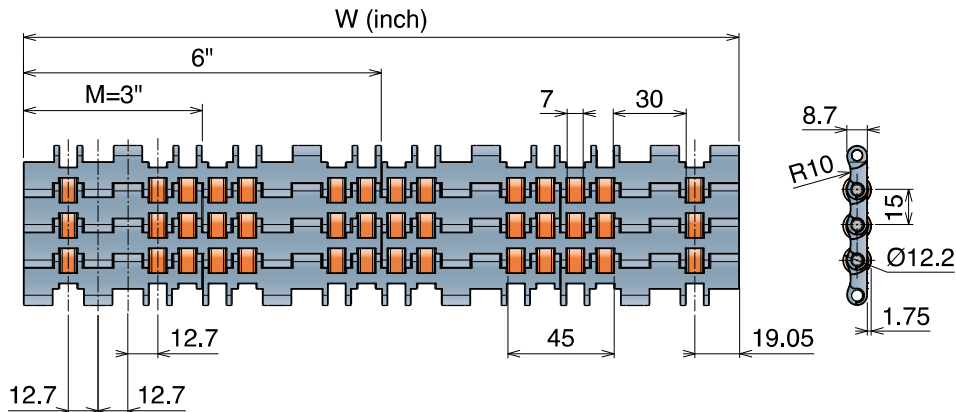

Guide position for accumulation system - Example

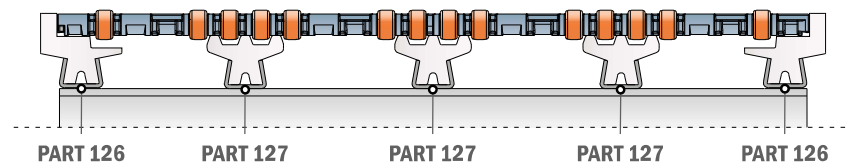

For accumulation system, please place the wear strips between the rollers (max 25 mm).

Guide position for driven rollers, for alignment/distribution system - Example

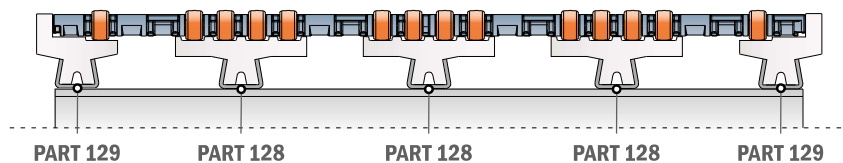

For driven rollers, please place the wear strips directly in contact under the rollers.

530 PRO LBP can also be used with standard profiles: consult extruded profiles section for more details.

Version A - Standard

Series	Material	Width	Version
5237	01	0006	A
5237	01	0009	A
5237	01	0012	A
5237	01	0015	A
5237	01	0018	A
5237	01	0021	A
5237	01	0024	A
5237	01	0027	A
5237	01	0030	A
5237	01	0033	A
5237	01	0036	A
5237	01	0039	A
5237	01	0042	A
5237	01	0045	A
5237	01	0048	A
5237	01	0051	A
5237	01	0054	A

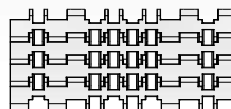

Rollers configuration for 530 PRO LBP, 6 inch wide belt.

Tappeti modulari / Modular belts / Mattenketten

550

Pitch 25,4 mm

H= 8,7 mm



550 FT
550 FT *One track Belt*
550 FTT
550 FG
550 FG *One track Belt*
550 GT

550 GT *Side indent*
550 FLIGHT TOP
550 PRO FT
550 PRO M

550 FT

Tappeto Modulare 550 FT, H=8,7 M=85
 Modular Belt Series 550 FT, H=8,7 M=85 / Modulare Mattenkette 550 FT, H=8,7 M=85

CODE STRUCTURE GUIDE (Example)

Backflex radius min.: 25 mm

5501	01	0085	A
Series	*Material	Width	Version

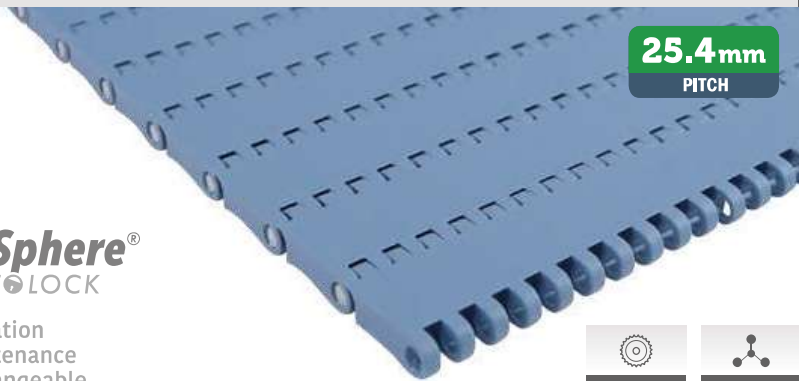

25.4 mm
PITCH

Metric Size

***Material**

LFA - Code 01

Low friction Acetal

Easy Delivery

Max w. load: 30000 N/m
 Weight: 8,5 kg/m²
 Temp. range dry: -40+80 °C
 Temp. range wet: -40+65 °C
 Pin material: PBT white

PP - Code 02

Polypropylene

Max w. load: 18000 N/m
 Weight: 8,4 kg/m²
 Temp. range dry: 4+104 °C
 Temp. range wet: 4+104 °C
 Pin material: PP blue

MX - Code 03

Performance PBT

Max w. load: 24000 N/m
 Weight: 8,2 kg/m²
 Temp. range dry: -40+120 °C
 Temp. range wet: -40+60 °C
 Pin material: POM grey

LFW - Code 05

Low friction Acetal

Max w. load: 30000 N/m
 Weight: 8,5 kg/m²
 Temp. range dry: -40+80 °C
 Temp. range wet: -40+65 °C
 Pin material: PBT white

DKM - Code 16

Aramide Reinforced Acetal

Max w. load: 30000 N/m
 Weight: 8,5 kg/m²
 Temp. range dry: -40+80 °C
 Temp. range wet: -40+65 °C
 Pin material: PBT white

MWX - Code 17

Polyamide Composite

Max w. load: 30000 N/m
 Weight: 8,9 kg/m²
 Temp. range dry: -40+104 °C
 Temp. range wet: NR
 Pin material: PBT white

LFB - Code 23

Low friction Acetal

Max w. load: 30000 N/m
 Weight: 8,5 kg/m²
 Temp. range dry: -40+80 °C
 Temp. range wet: -40+65 °C
 Pin material: PBT white

PFX - Code 30

Extra performance PBT

Max w. load: 24000 N/m
 Weight: 8,2 kg/m²
 Temp. range dry: -40+120 °C
 Temp. range wet: -40+60 °C
 Pin material: POM grey



- Easier installation
- Quicker maintenance
- 100% interchangeable

pg. 319/320 pg. 651>661

SAMPLE BOX

Art.-Nr. **550101888A**

Version A - Standard

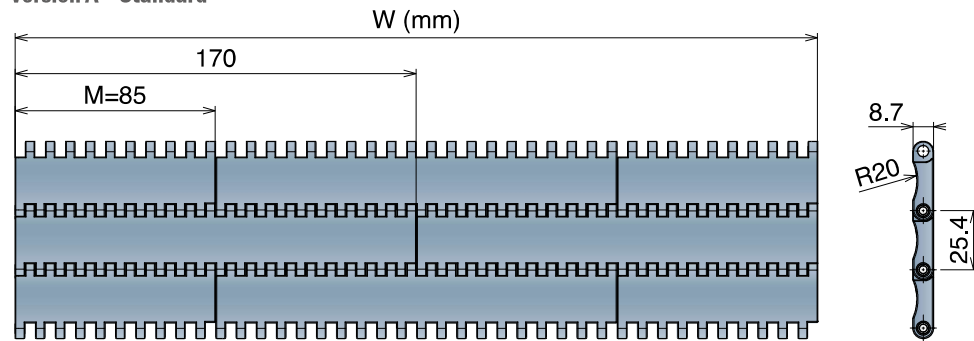

Version B - With 1 Positioner

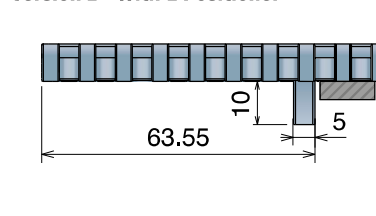

Version C - With 2 Positioners

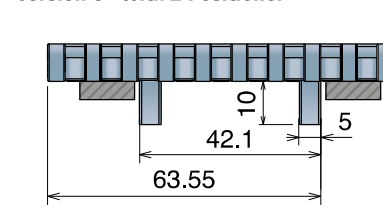

Version A - Standard

Series	Material	Width	Version
5501	*	0085	A
5501	*	0170	A
5501	*	0255	A
5501	*	0340	A
5501	*	0425	A
5501	*	0510	A
5501	*	0595	A
5501	*	0680	A
5501	*	0765	A
5501	*	0850	A
5501	*	0935	A
5501	*	1020	A
5501	*	1105	A
5501	*	1190	A
5501	*	1275	A
5501	*	1360	A
5501	*	1445	A
5501	*	1530	A

Version B - With 1 Positioner

Series	Material	Width	Version
5501	*	0085	B
5501	*	0170	B
5501	*	0255	B
5501	*	0340	B
5501	*	0425	B
5501	*	0510	B
5501	*	0595	B
5501	*	0680	B
5501	*	0765	B
5501	*	0850	B
5501	*	0935	B
5501	*	1020	B
5501	*	1105	B
5501	*	1190	B
5501	*	1275	B
5501	*	1360	B
5501	*	1445	B
5501	*	1530	B

Version C - With 2 Positioners

Series	Material	Width	Version
5501	*	0085	C
5501	*	0170	C
5501	*	0255	C
5501	*	0340	C
5501	*	0425	C
5501	*	0510	C
5501	*	0595	C
5501	*	0680	C
5501	*	0765	C
5501	*	0850	C
5501	*	0935	C
5501	*	1020	C
5501	*	1105	C
5501	*	1190	C
5501	*	1275	C
5501	*	1360	C
5501	*	1445	C
5501	*	1530	C

550 FT One track Belt

Tappeto Modulare 550 FT, H=8,7 K330
Modular Belt Series 550 FT, H=8,7 K330 / Modulare Mattenkette 550 FT, H=8,7 K330

CODE STRUCTURE GUIDE (Example)

Backflex radius min.: 25 mm

5221	01	9330	A
Series	*Material	Width	Version

	
pg. 319/320	pg. 651->661

*Material

LFA - Code 01

Low friction Acetal

Easy Delivery

Max w. load: 2500 N
Weight: 8,5 kg/m²
Temp. range dry: -40+80 °C
Temp. range wet: -40+65 °C
Pin material: PBT white

PP - Code 02

Polypropylene

Max w. load: 1500 N
Weight: 8,4 kg/m²
Temp. range dry: 4+104 °C
Temp. range wet: 4+104 °C
Pin material: PP blue

MX - Code 03

Performance PBT

Max w. load: 2000 N
Weight: 8,2 kg/m²
Temp. range dry: -40+120 °C
Temp. range wet: -40+60 °C
Pin material: POM grey

DKM - Code 16

Aramide Reinforced Acetal

Max w. load: 2500 N
Weight: 8,5 kg/m²
Temp. range dry: -40+80 °C
Temp. range wet: -40+65 °C
Pin material: PBT white

MWX - Code 17

Polyamide Composite

Max w. load: 2500 N
Weight: 8,9 kg/m²
Temp. range dry: -40+104 °C
Temp. range wet: NR
Pin material: PBT white

LFB - Code 23

Low friction Acetal

Max w. load: 2500 N
Weight: 8,5 kg/m²
Temp. range dry: -40+80 °C
Temp. range wet: -40+65 °C
Pin material: PBT white

PFX - Code 30

Extra performance PBT

Max w. load: 2000 N
Weight: 8,2 kg/m²
Temp. range dry: -40+120 °C
Temp. range wet: -40+60 °C
Pin material: POM grey

THE BEST CHOICE FOR DRY RUNNING APPLICATIONS



- Easier installation
- Quicker maintenance
- 10% Higher strength

Version A - Standard

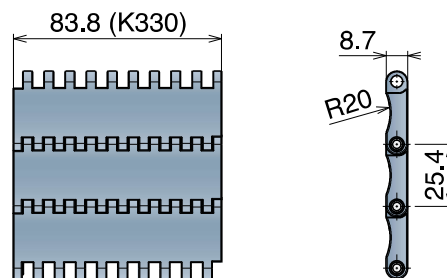

Series	Material	Width	Version
5221	*	9330	A

Version C - With 2 Positioner

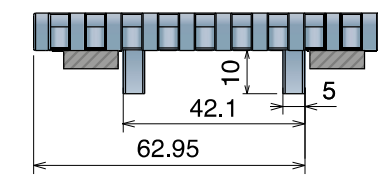

Series	Material	Width	Version
5221	*	9330	C

Disassembling / Assembling mode



NEW

550 FT One track belt MOVEX TOOL

The specific tool for belts developed to facilitate belt assembly and disassembly.



Article Nr. 29970

Movex tools are made with 3D printer, the color may vary due to availability of the material.

550 FTT

Tappeto Modulare 550 FTT, H=8,7 M=85
 Modular Belt Series 550 FTT, H=8,7 M=85 / Modulare Mattenkette 550 FTT, H=8,7 M=85

CODE STRUCTURE GUIDE (Example)

Backflex radius min.: 25 mm

5506	01	0085	C
Series	*Material	Width	Version

pg. 319/320	pg. 651>661

* Material

LFA - Code 01 Low friction Acetal	MX - Code 03 Performance PBT
---	--

Max w. load: 30000 N/m	Max w. load: 24000 N/m
Weight: 8,5 kg/m ²	Weight: 8,2 kg/m ²
Temp. range dry: -40+80 °C	Temp. range dry: -40+120 °C
Temp. range wet: -40+65 °C	Temp. range wet: -40+60 °C
Pin material: PBT white	Pin material: POM grey



- Easier installation
- Quicker maintenance
- 100% interchangeable

Metric Size

25.4 mm
PITCH

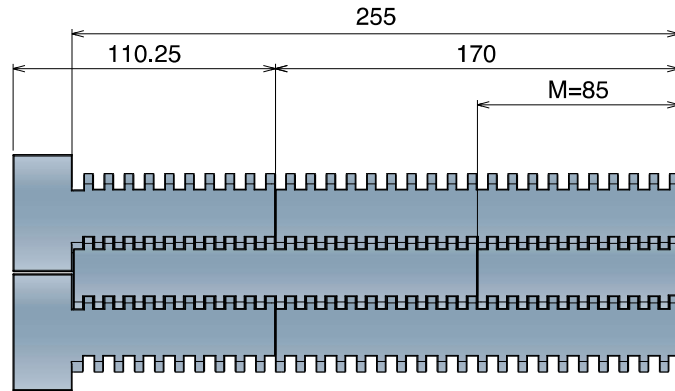
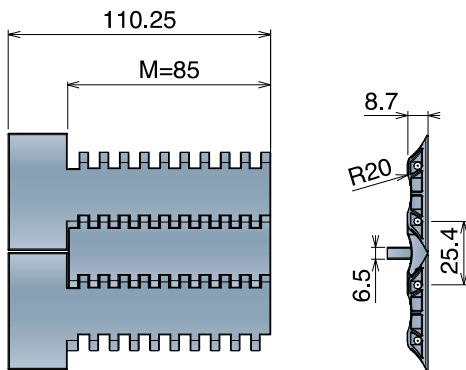

Version C

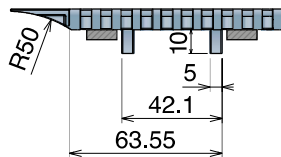

Version CN - Near

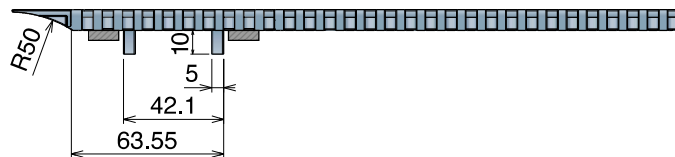

Version C

Series	Material	Width	Version
5506	*	0085	C

Version C0 - Opposite

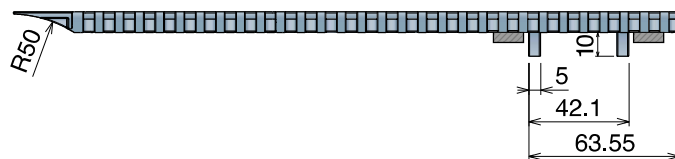

Max working load (N)

Width	85
LFA	2300
MX	1850

Version CN - Near

Series	Material	Width	Version
5506	*	0170	CN
5506	*	0255	CN

Version C0 - Opposite

Series	Material	Width	Version
5506	*	0170	C0
5506	*	0255	C0

550 FG Open Surface 25% Tappeto Modulare 550 FG, H=8,7 M=85 / Modular Belt Series 550 FG, H=8,7 M=85 / Modulare Mattenkette 550 FG, H=8,7 M=85

CODE STRUCTURE GUIDE (Example)

Backflex radius min.: 25 mm

5222	01	0085	A
Series	*Material	Width	Version

	
pg. 319/320	pg. 651->661

SAMPLE BOX	
Art.-Nr.	522201888A



Metric Size

*Material

LFA - Code 01
Low friction Acetal

Easy Delivery

Max w. load: 27500 N/m
Weight: 7,0 kg/m²
Temp. range dry: -40+80 °C
Temp. range wet: -40+65 °C
Pin material: PBT white

MX - Code 03
Performance PBT

Max w. load: 22000 N/m
Weight: 6,7 kg/m²
Temp. range dry: -40+120 °C
Temp. range wet: -40+60 °C
Pin material: POM grey

LFB - Code 23
Low friction Acetal

Max w. load: 27500 N/m
Weight: 7,0 kg/m²
Temp. range dry: -40+80 °C
Temp. range wet: -40+65 °C
Pin material: PBT white

PFX - Code 30
Extra performance PBT

Max w. load: 22000 N/m
Weight: 6,7 kg/m²
Temp. range dry: -40+120 °C
Temp. range wet: -40+60 °C
Pin material: POM grey

THE BEST CHOICE FOR DRY RUNNING APPLICATIONS

Version A - Standard

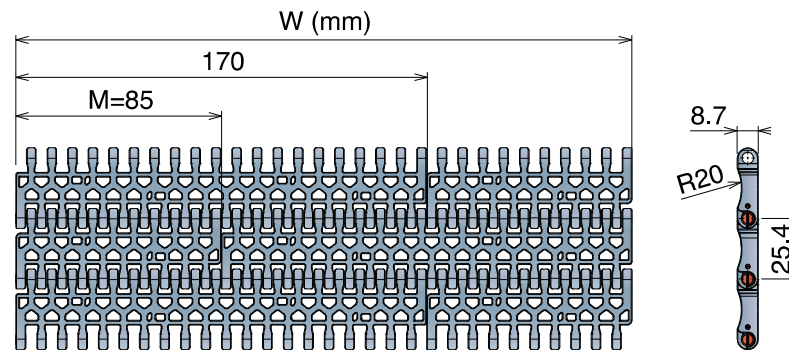

Version B - With 1 Positioner

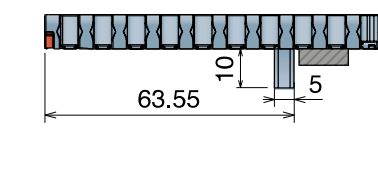

Version C - With 2 Positioner

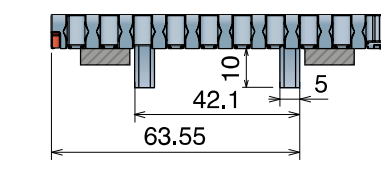

Version A - Standard

Series	Material	Width	Version
5222	*	0085	A
5222	*	0170	A
5222	*	0255	A
5222	*	0340	A
5222	*	0425	A
5222	*	0510	A
5222	*	0595	A
5222	*	0680	A
5222	*	0765	A
5222	*	0850	A
5222	*	0935	A
5222	*	1020	A
5222	*	1105	A
5222	*	1190	A
5222	*	1275	A
5222	*	1360	A
5222	*	1445	A
5222	*	1530	A

Version B - With 1 Positioner

Series	Material	Width	Version
5222	*	0085	B
5222	*	0170	B
5222	*	0255	B
5222	*	0340	B
5222	*	0425	B
5222	*	0510	B
5222	*	0595	B
5222	*	0680	B
5222	*	0765	B
5222	*	0850	B
5222	*	0935	B
5222	*	1020	B
5222	*	1105	B
5222	*	1190	B
5222	*	1275	B
5222	*	1360	B
5222	*	1445	B
5222	*	1530	B

Version C - With 2 Positioners

Series	Material	Width	Version
5222	*	0085	C
5222	*	0170	C
5222	*	0255	C
5222	*	0340	C
5222	*	0425	C
5222	*	0510	C
5222	*	0595	C
5222	*	0680	C
5222	*	0765	C
5222	*	0850	C
5222	*	0935	C
5222	*	1020	C
5222	*	1105	C
5222	*	1190	C
5222	*	1275	C
5222	*	1360	C
5222	*	1445	C
5222	*	1530	C

550 FG One track Belt Open Surface 25% Tappeto Modulare 550 FG, H=8,7 K330 Modular Belt Series 550 FG, H=8,7 K330 / Modulare Mattenkette 550 FG, H=8,7 K330

CODE STRUCTURE GUIDE (Example)

Backflex radius min.: 25 mm

5222	01	9330	A
Series	*Material	Width	Version

	
pg. 319/320	pg. 651>661



Metric Size

* Material

LFA - Code 01

Low friction Acetal

Easy Delivery

Max w. load: 2300 N
Weight: 7,0 kg/m²
Temp. range dry: -40+80 °C
Temp. range wet: -40+65 °C
Pin material: PBT white

MX - Code 03

Performance PBT

Max w. load: 1850 N
Weight: 6,7 kg/m²
Temp. range dry: -40+120 °C
Temp. range wet: -40+60 °C
Pin material: POM grey

LFB - Code 23

Low friction Acetal

Max w. load: 2300 N
Weight: 7,0 kg/m²
Temp. range dry: -40+80 °C
Temp. range wet: -40+65 °C
Pin material: PBT white

PFX - Code 30

Extra performance PBT

Max w. load: 1850 N
Weight: 6,7 kg/m²
Temp. range dry: -40+120 °C
Temp. range wet: -40+60 °C
Pin material: POM grey

**THE BEST CHOICE FOR
DRY RUNNING APPLICATIONS**

Version A - Standard

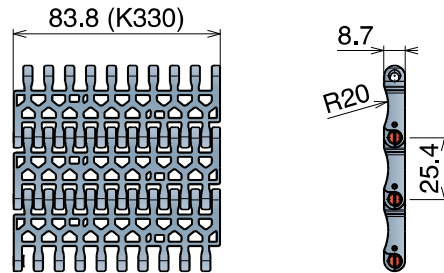

Version C - With 2 Positioner

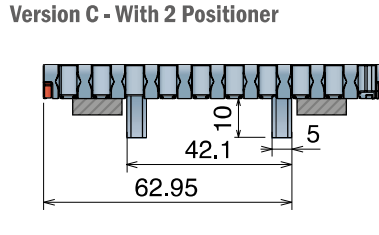

Version A - Standard

Series	Material	Width	Version
5222	*	9330	A

Version C - With 2 Positioners

Series	Material	Width	Version
5222	*	9330	C

550 GT

Tappeto Modulare 550 GT, H=8,7 M=85
 Modular Belt Series 550 GT, H=8,7 M=85 / Modulare Mattenkette 550 GT, H=8,7 M=85

CODE STRUCTURE GUIDE (Example)

Backflex radius min.: 30 mm

5503	01	0085	A
Series	*Material	Width	Version



SAMPLE BOX	
Art.-Nr.	5503018888A



- Easier installation
- Quicker maintenance
- 100% interchangeable



25.4 mm
PITCH

Metric Size

*Material

LFA - Code 01

Low friction Acetal

Max w. load: 27500 N/m
 Weight: 10,1 kg/m²
 Temp. range dry: -40+80 °C
 Temp. range wet: -40+65 °C
 Pin material: PBT white
 Top rubber: 50 ShA-Dark grey

PP - Code 02

Polypropylene

Max w. load: 16500 N/m
 Weight: 8,4 kg/m²
 Temp. range dry: 4+80 °C
 Temp. range wet: 4+80 °C
 Pin material: PP blue
 Top rubber: 50 ShA-Pigeon blue

MX - Code 03

Performance PBT

Max w. load: 21500 N/m
 Weight: 10,5 kg/m²
 Temp. range dry: -40+120 °C
 Temp. range wet: -40+60 °C
 Pin material: POM grey
 Top rubber: 50 ShA-Dark grey

Version A - Standard

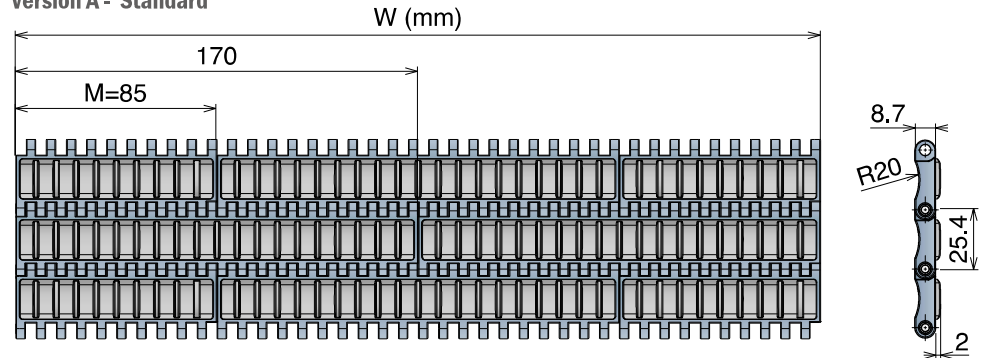

Version B - With 1 Positioner

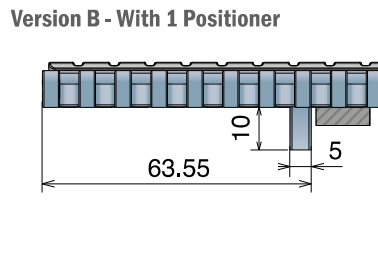

Version C - With 2 Positioners

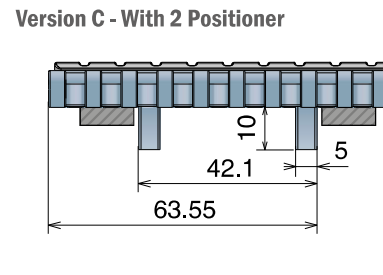

Version A - Standard

Series	Material	Width	Version
5503	*	0085	A
5503	*	0170	A
5503	*	0255	A
5503	*	0340	A
5503	*	0425	A
5503	*	0510	A
5503	*	0595	A
5503	*	0680	A
5503	*	0765	A
5503	*	0850	A
5503	*	0935	A
5503	*	1020	A
5503	*	1105	A
5503	*	1190	A
5503	*	1275	A
5503	*	1360	A
5503	*	1445	A
5503	*	1530	A

Version B - With 1 Positioner

Series	Material	Width	Version
5503	*	0085	B
5503	*	0170	B
5503	*	0255	B
5503	*	0340	B
5503	*	0425	B
5503	*	0510	B
5503	*	0595	B
5503	*	0680	B
5503	*	0765	B
5503	*	0850	B
5503	*	0935	B
5503	*	1020	B
5503	*	1105	B
5503	*	1190	B
5503	*	1275	B
5503	*	1360	B
5503	*	1445	B
5503	*	1530	B

Version C - With 2 Positioners

Series	Material	Width	Version
5503	*	0085	C
5503	*	0170	C
5503	*	0255	C
5503	*	0340	C
5503	*	0425	C
5503	*	0510	C
5503	*	0595	C
5503	*	0680	C
5503	*	0765	C
5503	*	0850	C
5503	*	0935	C
5503	*	1020	C
5503	*	1105	C
5503	*	1190	C
5503	*	1275	C
5503	*	1360	C
5503	*	1445	C
5503	*	1530	C

550 GT Side indent Tappeto Modulare 550 GT, H=8,7 M=85 Modular Belt Series 550 GT, H=8,7 M=85 / Modulare Mattenkette 550 GT, H=8,7 M=85

CODE STRUCTURE GUIDE (Example)

Backflex radius min.: 30 mm

5505	01	0255	A
Series	*Material	Width	Version



pg. 319/320

pg. 651-661



- Easier installation
- Quicker maintenance
- 100% interchangeable

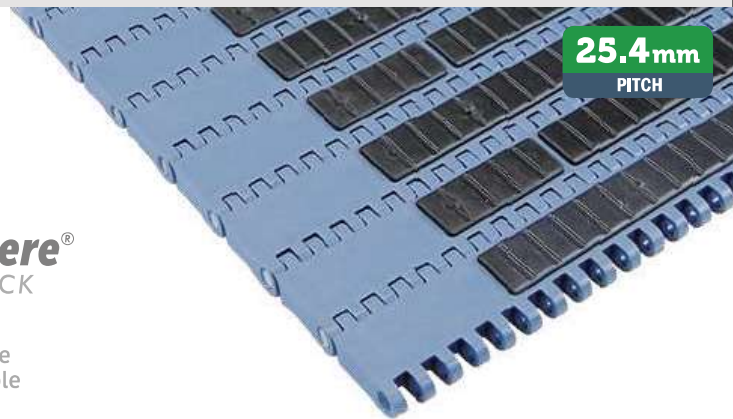

25.4 mm
PITCH

Metric Size

*Material

LFA - Code 01 Low friction Acetal

Max w. load: 27500 N/m
Weight: 10,1 kg/m²
Temp. range dry: -40+80 °C
Temp. range wet: -40+65 °C
Pin material: PBT white
Top rubber: 50 ShA-Dark grey

PP - Code 02 Polypropylene

Max w. load: 16500 N/m
Weight: 8,4 kg/m²
Temp. range dry: 4+80 °C
Temp. range wet: 4+80 °C
Pin material: PP blue
Top rubber: 50 ShA-Pigeon blue

MX - Code 03 Performance PBT

Max w. load: 21500 N/m
Weight: 10,5 kg/m²
Temp. range dry: -40+120 °C
Temp. range wet: -40+60 °C
Pin material: POM grey
Top rubber: 50 ShA-Dark grey

Version A - Standard

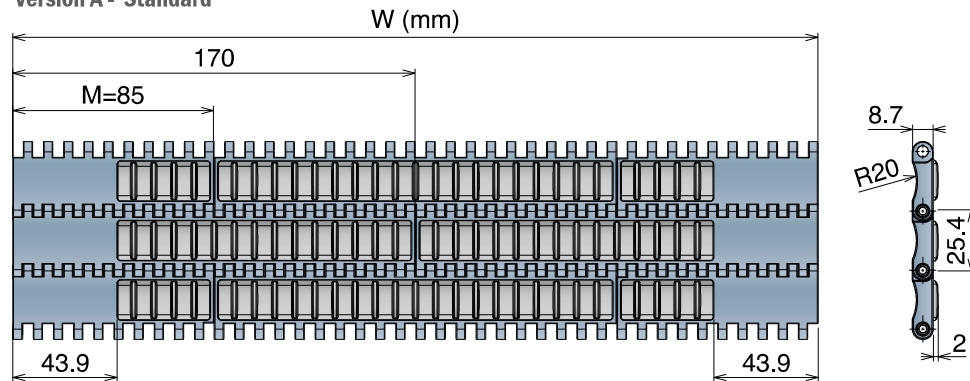

Version B - With 1 Positioner

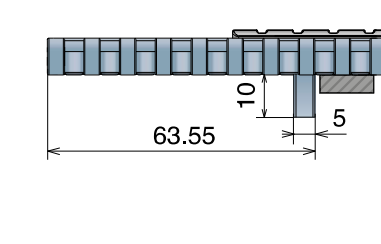

Version C - With 2 Positioners

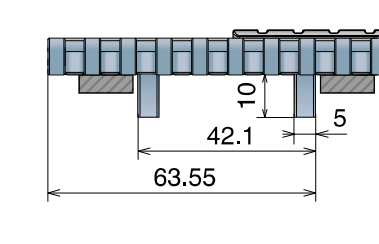

Version A - Standard

Series	Material	Width	Version
5505	*	0255	A
5505	*	0340	A
5505	*	0425	A
5505	*	0510	A
5505	*	0595	A
5505	*	0680	A
5505	*	0765	A
5505	*	0850	A
5505	*	0935	A
5505	*	1020	A
5505	*	1105	A
5505	*	1190	A
5505	*	1275	A
5505	*	1360	A
5505	*	1445	A
5505	*	1530	A

Version B - With 1 Positioner

Series	Material	Width	Version
5505	*	0255	B
5505	*	0340	B
5505	*	0425	B
5505	*	0510	B
5505	*	0595	B
5505	*	0680	B
5505	*	0765	B
5505	*	0850	B
5505	*	0935	B
5505	*	1020	B
5505	*	1105	B
5505	*	1190	B
5505	*	1275	B
5505	*	1360	B
5505	*	1445	B
5505	*	1530	B

Version C - With 2 Positioners

Series	Material	Width	Version
5505	*	0255	C
5505	*	0340	C
5505	*	0425	C
5505	*	0510	C
5505	*	0595	C
5505	*	0680	C
5505	*	0765	C
5505	*	0850	C
5505	*	0935	C
5505	*	1020	C
5505	*	1105	C
5505	*	1190	C
5505	*	1275	C
5505	*	1360	C
5505	*	1445	C
5505	*	1530	C

NEW 550 FLIGHT TOP Tappeto Modulare 550 with Flight, H=8,7 M=85
 Modular Belt Series 550 with Flight, H=8,7 M=85 / Modulare Mattenkette 550 with Flight, H=8,7 M=85

Metric Size

CODE STRUCTURE GUIDE

Backflex radius min.: 30 mm

See following table

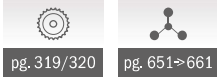

pg. 319/320

pg. 651>661

SAMPLE BOX

Art.-Nr. 5503018888A

Material

LFA - Code 01

Low friction Acetal

Max w. load: 30000 N/m
Weight: 8,5 kg/m²
Temp. range dry: -40+80 °C
Temp. range wet: -40+65 °C
Pin material: PBT white

PP - Code 02

Polypropylene

Max w. load: 18000 N/m
Weight: 8,4 kg/m²
Temp. range dry: 4+104 °C
Temp. range wet: 4+104 °C
Pin material: PP blue

LFW - Code 05

Low friction Acetal

Max w. load: 30000 N/m
Weight: 8,5 kg/m²
Temp. range dry: -40+80 °C
Temp. range wet: -40+65 °C
Pin material: PBT white

PPW - Code 21

Polypropylene

Max w. load: 18000 N/m
Weight: 8,4 kg/m²
Temp. range dry: 4+80 °C
Temp. range wet: 4+65 °C
Pin material: PP blu

LFB - Code 23

Low friction Acetal

Max w. load: 30000 N/m
Weight: 8,5 kg/m²
Temp. range dry: -40+80 °C
Temp. range wet: -40+65 °C
Pin material: PBT white



- Easier installation
- Quicker maintenance
- 100% interchangeable

Version A - Standard

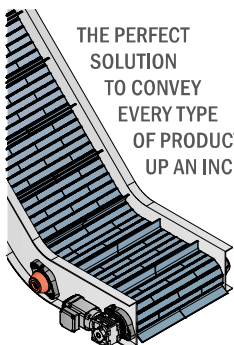
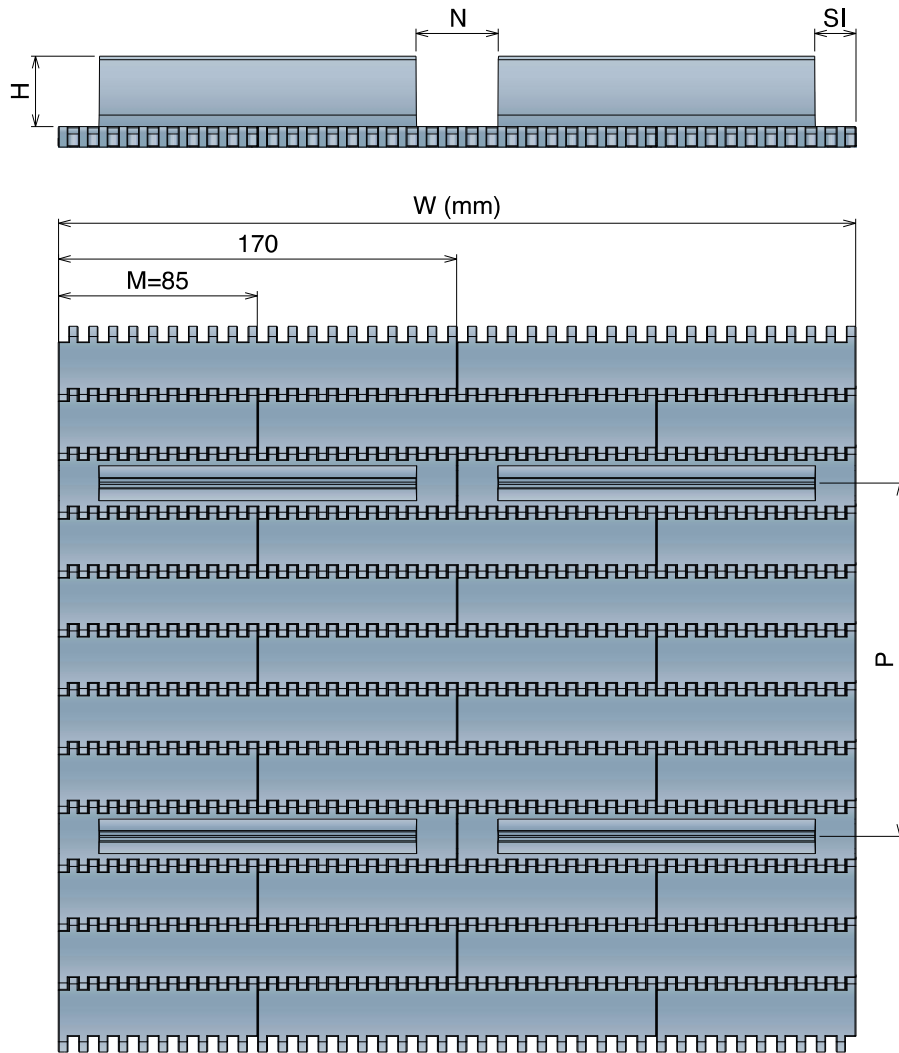

THE PERFECT SOLUTION TO CONVEY EVERY TYPE OF PRODUCTS UP AN INCLINE!

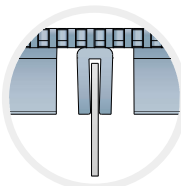

Notch utility
 RETURN SECTION with Bar-cap

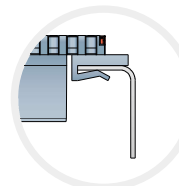

Side indent utility
 RETURN SECTION with Z-Profile & J-Profile

Request for quotation

Technical drawing

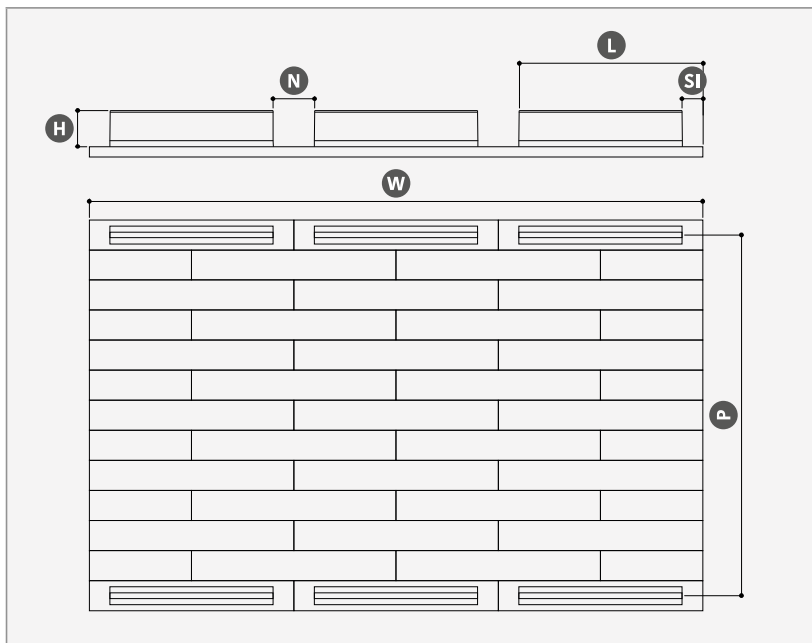

Company

Sales contact

Contact

Date

For different combination, please ask to your sales representative.

Fill out the form and send to your sales contact or to:

info@movexii.com

Please fill out the following form or add dimensions into the drawing.

Technical features

Dimension expressed in millimeter

Belt surface	Flat Top (FT)		Flush Grid (FG)		Grip Top (GT)	
Material & colour	LFA	LFW	LFB	PP	PPW	
W - Width	Standard (85 multiple)			Special (17 multiple)		
H - Flight height	Standard	Standard	Standard	Special (Max 76)		
	30	51	76			
P - Pitch	Number of pitches or distance between flights (25,4 mm multiple)					
SI - Side Indent*	No	17	30	50		
Notch*	No	Single	Double	Triple		
	N - Notch width (preferred 34 or 60 mm)			L - Notch distance (2 or more)		

Configuration recommended

Dimensions expressed in millimeter

Width ≤ 170	170 > Width ≤ 425	425 > Width ≤ 850	Width > 850

550 PRO FT

Tappeto Modulare 550 PRO FT, H=8,7 K330
 Modular Belt Series 550 PRO FT, H=8,7 K330 / Modulare Mattenkette 550 PRO FT, H=8,7 K330

CODE STRUCTURE GUIDE (Example)

Backflex radius min.: 25 mm

5227	01	9330	A
Series	*Material	Width	Version

25.4 mm
PITCH

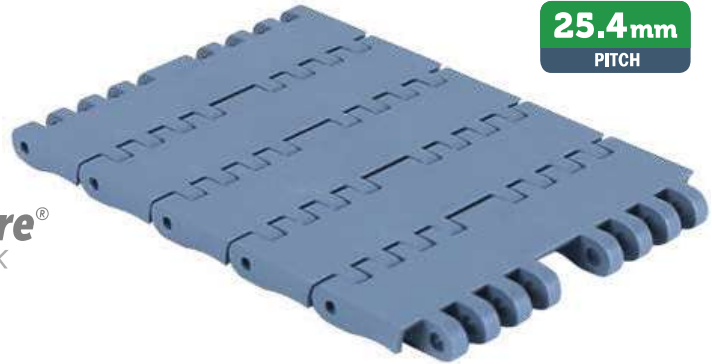

Metric Size



550 PRO FT & PRO M
 SAMPLE BOX
 Art.-Nr. 5227018888A



- Easier installation
- Quicker maintenance
- 100% interchangeable

*Material

LFA - Code 01
 Low friction Acetal

Easy Delivery

Max w. load: 2300 N
 Weight: 8,5 kg/m²
 Temp. range dry: -40+80 °C
 Temp. range wet: -40+65 °C
 Pin material: PBT white

MX - Code 03
 Performance PBT

Max w. load: 1850 N
 Weight: 8,2 kg/m²
 Temp. range dry: -40+120 °C
 Temp. range wet: -40+60 °C
 Pin material: POM grey

PFX - Code 30
 Extra performance PBT

Max w. load: 1850 N
 Weight: 8,2 kg/m²
 Temp. range dry: -40+120 °C
 Temp. range wet: -40+60 °C
 Pin material: POM grey

**THE BEST CHOICE FOR
 DRY RUNNING APPLICATIONS**

Version A - Standard

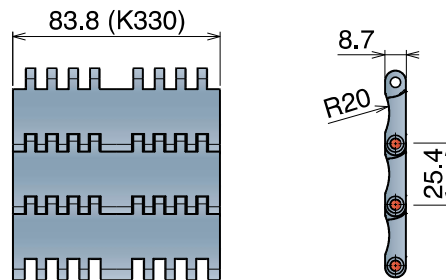

Version C - With 2 Positioner

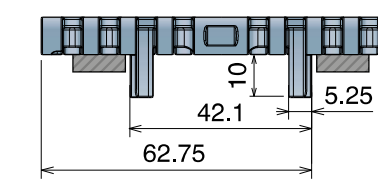

Advantages:

- Optimized product support
- Superior flatness
- Low wear
- Bi-directional

Version A - Standard

Series	Material	Width	Version
5227	*	9330	A

Version C - With 2 Positioners

Series	Material	Width	Version
5227	*	9330	C

550 PRO FT & 550 PRO FT

The perfect combination

- Same height between guide and center sprockets (S Dimension)
- Same speed for curved and straight
- Unique sprocket for curved and straight

Layout with 550 Pro M and 550 PRO FT

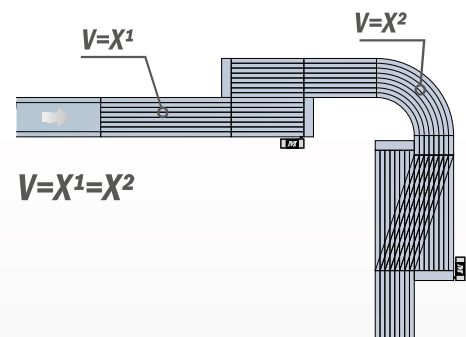

551

Pitch 25,4 mm

H= 12,7 mm



- 551 FT
- 551 FTT
- 551 GT
- 551 GT *Side indent*
- 551 LBP
- 551 PRO LBP

551 FT

Tappeto Modulare 551 FT, H=12,7 M=85
Modular Belt Series 551 FT, H=12,7 M=85 / Modulare Mattenkette 551 FT, H=12,7 M=85

CODE STRUCTURE GUIDE (Example)

5231	01	0085	A
Series	*Material	Width	Version

Backflex radius min.: 25 mm

25.4 mm
PITCH

Metric Size

*Material

LFA - Code 01
Low friction Acetal

Easy Delivery

Max w. load: 41500 N/m
Weight: 12,5 kg/m²
Temp. range dry: -40÷80 °C
Temp. range wet: -40÷65 °C
Pin material: PBT white

PP - Code 02
Polypropylene

Max w. load: 27000 N/m
Weight: 10,0 kg/m²
Temp. range dry: 4÷104 °C
Temp. range wet: 4÷104 °C
Pin material: PP blue

MX - Code 03
Performance PBT

Max w. load: 33500 N/m
Weight: 12,0 kg/m²
Temp. range dry: -40÷120 °C
Temp. range wet: -40÷60 °C
Pin material: POM grey

DKM - Code 16
Aramide Reinforced Acetal

Max w. load: 41500 N/m
Weight: 12,5 kg/m²
Temp. range dry: -40÷80 °C
Temp. range wet: -40÷65 °C
Pin material: PBT white

MWX - Code 17
Polyamide Composite

Max w. load: 41500 N/m
Weight: 13,0 kg/m²
Temp. range dry: -40÷104 °C
Temp. range wet: NR
Pin material: PBT white

MPX - Code 25
Lubricated Acetal

Max w. load: 41500 N/m
Weight: 12,5 kg/m²
Temp. range dry: -40÷80 °C
Temp. range wet: -40÷65 °C
Pin material: PBT white

PFX - Code 30
Extra performance PBT

Max w. load: 33500 N/m
Weight: 12,0 kg/m²
Temp. range dry: -40÷120 °C
Temp. range wet: -40÷60 °C
Pin material: POM grey

**THE BEST CHOICE FOR
DRY RUNNING APPLICATIONS**

SAMPLE BOX

Art.-Nr. **523101888A**



Version A - Standard

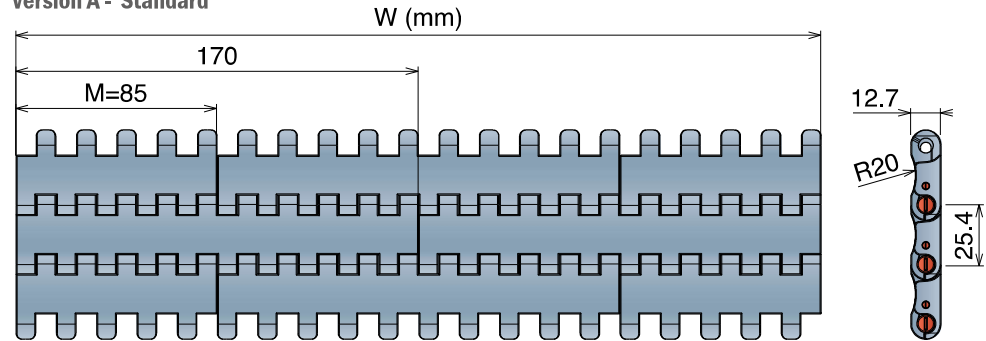

Version B - With 1 Positioner

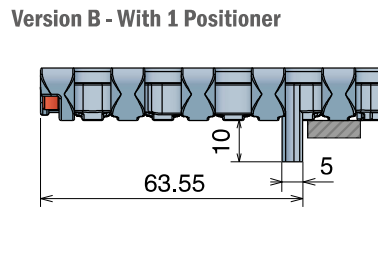

Version C - With 2 Positioners

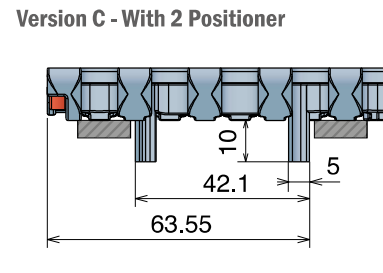

Version A - Standard

Series	Material	Width	Version
5231	*	0085	A
5231	*	0170	A
5231	*	0255	A
5231	*	0340	A
5231	*	0425	A
5231	*	0510	A
5231	*	0595	A
5231	*	0680	A
5231	*	0765	A
5231	*	0850	A
5231	*	0935	A
5231	*	1020	A
5231	*	1105	A
5231	*	1190	A
5231	*	1275	A
5231	*	1360	A
5231	*	1445	A
5231	*	1530	A

Version B - With 1 Positioner

Series	Material	Width	Version
5231	*	0085	B
5231	*	0170	B
5231	*	0255	B
5231	*	0340	B
5231	*	0425	B
5231	*	0510	B
5231	*	0595	B
5231	*	0680	B
5231	*	0765	B
5231	*	0850	B
5231	*	0935	B
5231	*	1020	B
5231	*	1105	B
5231	*	1190	B
5231	*	1275	B
5231	*	1360	B
5231	*	1445	B
5231	*	1530	B

Version C - With 2 Positioners

Series	Material	Width	Version
5231	*	0085	C
5231	*	0170	C
5231	*	0255	C
5231	*	0340	C
5231	*	0425	C
5231	*	0510	C
5231	*	0595	C
5231	*	0680	C
5231	*	0765	C
5231	*	0850	C
5231	*	0935	C
5231	*	1020	C
5231	*	1105	C
5231	*	1190	C
5231	*	1275	C
5231	*	1360	C
5231	*	1445	C
5231	*	1530	C

551 FTT

Tappeti modulari / Modular belts / Mattenketten

Belts wider than standard are available with 85 mm increments

551 FTT

Tappeto Modulare 551 FTT, H=12,7 M=85

Modular Belt Series 551 FTT, H=12,7 M=85 / Modulare Mattenkette 551 FTT, H=12,7 M=85

CODE STRUCTURE GUIDE (Example)

Backflex radius min.: 25 mm

5236	01	0085	C
Series	*Material	Width	Version

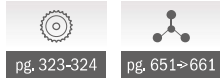

pg. 323-324

pg. 651->661

25.4mm
PITCH

*Material

LFA - Code 01

Low friction Acetal

MX - Code 03

Performance PBT

MPX - Code 25

Lubricated Acetal

Max w. load: 41500 N/m	Max w. load: 33500 N/m	Max w. load: 41500 N/m
Weight: 12,5 kg/m ²	Weight: 12,0 kg/m ²	Weight: 12,5 kg/m ²
Temp. range dry: -40+80 °C	Temp. range dry: -40+120 °C	Temp. range dry: -40+80 °C
Temp. range wet: -40+65 °C	Temp. range wet: -40+60 °C	Temp. range wet: -40+65 °C
Pin material: PBT white	Pin material: POM grey	Pin material: PBT white

Metric Size

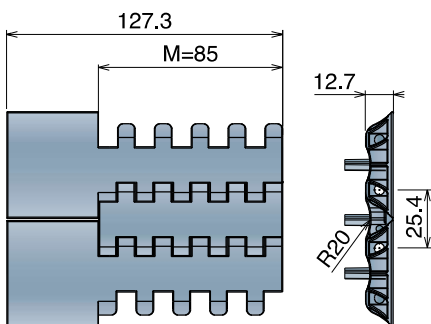

Version C

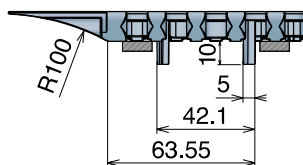

Version C

Series	Material	Width	Version
5236	*	0085	C

Max working load (N)

Width	85
LFA	3500
MX	2800
MPX	3500

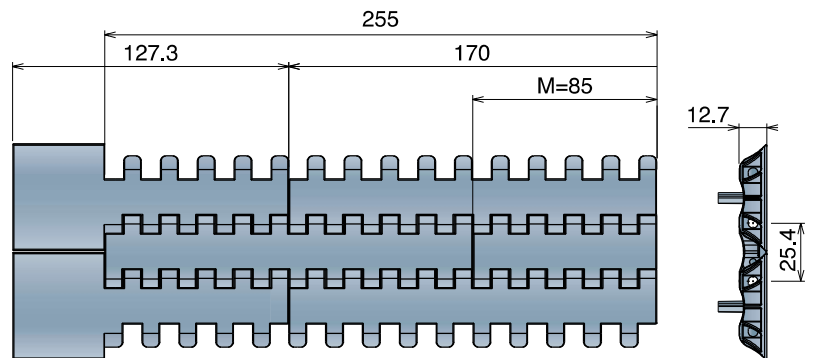

Version CN - Near

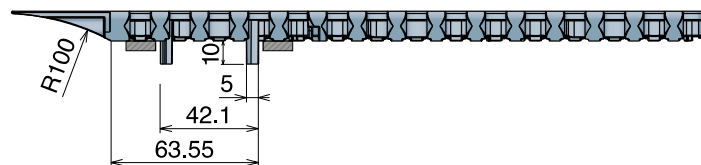

Version C0 - Opposite

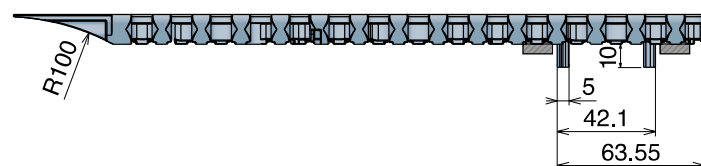

Version CN - Near

Series	Material	Width	Version
5236	*	0170	CN
5236	*	0255	CN

Version C0 - Opposite

Series	Material	Width	Version
5236	*	0170	C0
5236	*	0255	C0

Tappeti modulari / Modular belts / Mattenketten

551 GT

Tappeto Modulare 551 GT, H=12,7 M=85
 Modular Belt Series 551 GT, H=12,7 M=85 / Modulare Mattenkette 551 GT, H=12,7 M=85

CODE STRUCTURE GUIDE (Example)

Backflex radius min.: 50 mm

5233	01	0085	A
Series	*Material	Width	Version

pg. 323-324	pg. 651->661

SAMPLE BOX	
Art.-Nr.	5233018988A

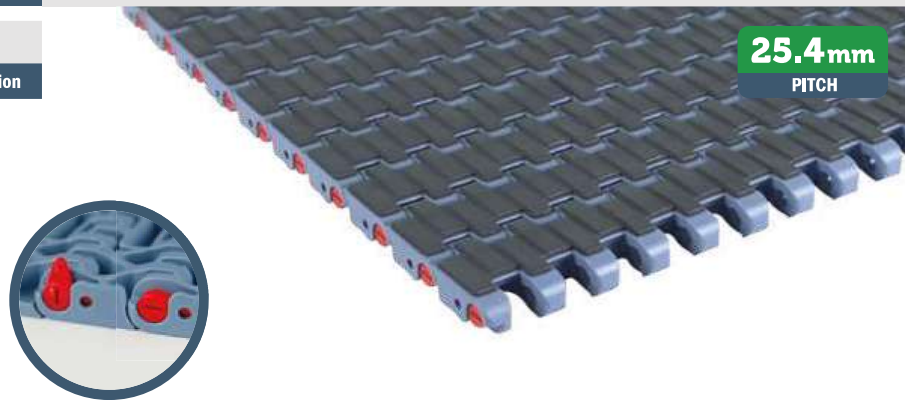

Metric Size

* Material

LFA - Code 01

Low friction Acetal

Easy Delivery

Max w. load: 41500 N/m
 Weight: 13,5 kg/m²
 Temp. range dry: -40+80 °C
 Temp. range wet: -40+65 °C
 Pin material: PBT white
 Top rubber: 50 ShA-Dark grey

PP - Code 02

Polypropylene

Max w. load: 27000 N/m
 Weight: 11,0 kg/m²
 Temp. range dry: 4+80 °C
 Temp. range wet: 4+80 °C
 Pin material: PP blue
 Top rubber: 50 ShA-Pigeon blue

MX - Code 03

Performance PBT

Max w. load: 33500 N/m
 Weight: 12,7 kg/m²
 Temp. range dry: -40+120 °C
 Temp. range wet: -40+60 °C
 Pin material: POM grey
 Top rubber: 50 ShA-Dark grey

Version A - Standard

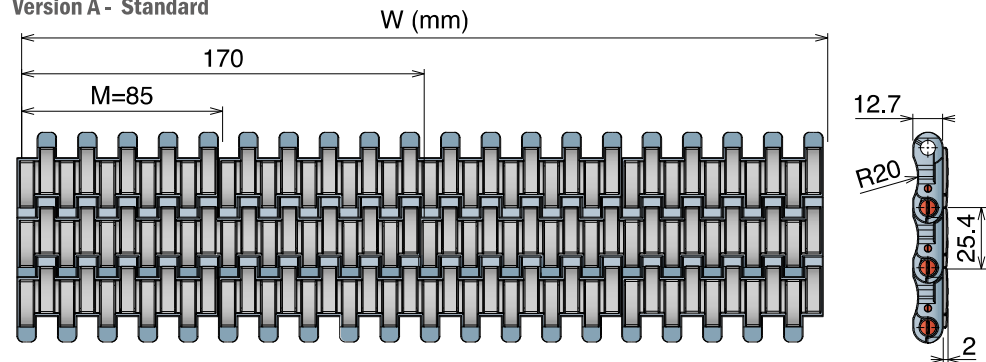

Version B - With 1 Positioner

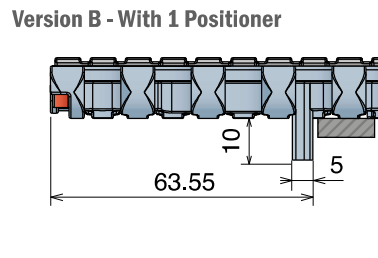

Version C - With 2 Positioner

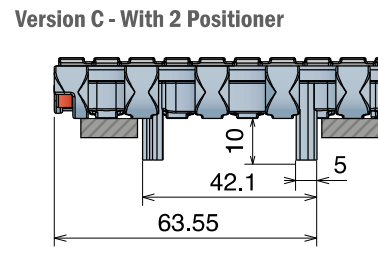

Version A - Standard

Series	Material	Width	Version
5233	*	0085	A
5233	*	0170	A
5233	*	0255	A
5233	*	0340	A
5233	*	0425	A
5233	*	0510	A
5233	*	0595	A
5233	*	0680	A
5233	*	0765	A
5233	*	0850	A
5233	*	0935	A
5233	*	1020	A
5233	*	1105	A
5233	*	1190	A
5233	*	1275	A
5233	*	1360	A
5233	*	1445	A
5233	*	1530	A

Version B - With 1 Positioner

Series	Material	Width	Version
5233	*	0085	B
5233	*	0170	B
5233	*	0255	B
5233	*	0340	B
5233	*	0425	B
5233	*	0510	B
5233	*	0595	B
5233	*	0680	B
5233	*	0765	B
5233	*	0850	B
5233	*	0935	B
5233	*	1020	B
5233	*	1105	B
5233	*	1190	B
5233	*	1275	B
5233	*	1360	B
5233	*	1445	B
5233	*	1530	B

Version C - With 2 Positioners

Series	Material	Width	Version
5233	*	0085	C
5233	*	0170	C
5233	*	0255	C
5233	*	0340	C
5233	*	0425	C
5233	*	0510	C
5233	*	0595	C
5233	*	0680	C
5233	*	0765	C
5233	*	0850	C
5233	*	0935	C
5233	*	1020	C
5233	*	1105	C
5233	*	1190	C
5233	*	1275	C
5233	*	1360	C
5233	*	1445	C
5233	*	1530	C

551 GT Side indent

Tappeti modulari / Modular belts / Mattenketten

Belts wider than standard are available with 85 mm increments

551 GT Side indent Tappeto Modulare 551 GT, H=12,7 M=85 Modular Belt Series 551 GT, H=12,7 M=85 / Modulare Mattenkette 551 GT, H=12,7 M=85

CODE STRUCTURE GUIDE (Example)

Backflex radius min.: 50 mm

5235	01	0255	A
Series	*Material	Width	Version

	
pg. 323-324	pg. 651->661

25.4 mm
PITCH

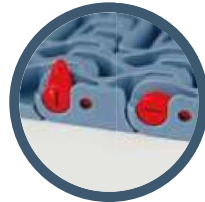

Metric Size

*Material

LFA - Code 01
Low friction Acetal

Easy Delivery

Max w. load: 41500 N/m
Weight: 13,5 kg/m²
Temp. range dry: -40+80 °C
Temp. range wet: -40+65 °C
Pin material: PBT white
Top rubber: 50 Sha-Dark grey

PP - Code 02
Polypropylene

Max w. load: 27000 N/m
Weight: 11,0 kg/m²
Temp. range dry: 4+80 °C
Temp. range wet: 4+80 °C
Pin material: PP blue
Top rubber: 50 Sha-Pigeon blue

MX - Code 03
Performance PBT

Max w. load: 33500 N/m
Weight: 12,7 kg/m²
Temp. range dry: -40+120 °C
Temp. range wet: -40+60 °C
Pin material: POM grey
Top rubber: 50 Sha-Dark grey

Version A - Standard

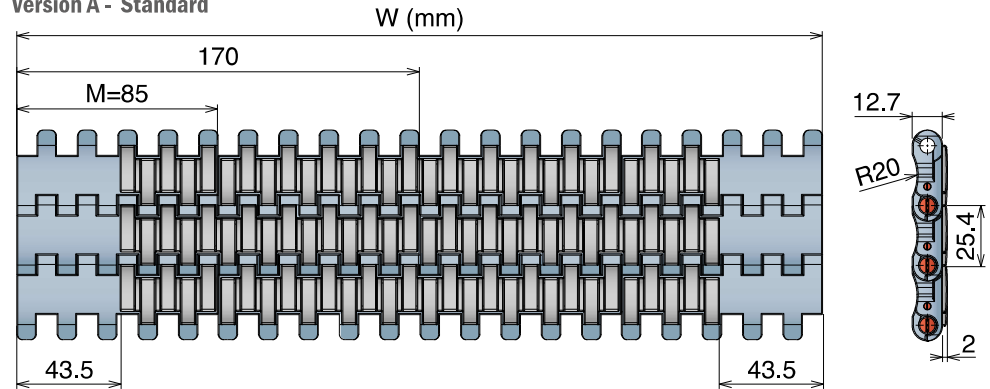

Version B - With 1 Positioner

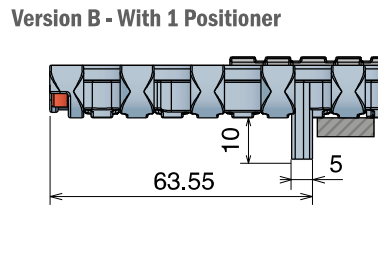

Version C - With 2 Positioner

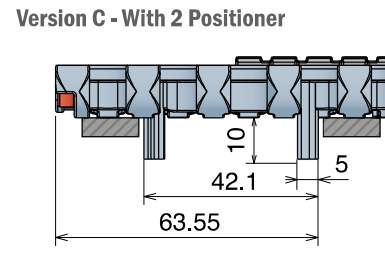

Version A - Standard

Series	Material	Width	Version
5235	*	0255	A
5235	*	0340	A
5235	*	0425	A
5235	*	0510	A
5235	*	0595	A
5235	*	0680	A
5235	*	0765	A
5235	*	0850	A
5235	*	0935	A
5235	*	1020	A
5235	*	1105	A
5235	*	1190	A
5235	*	1275	A
5235	*	1360	A
5235	*	1445	A
5235	*	1530	A

Version B - With 1 Positioner

Series	Material	Width	Version
5235	*	0255	B
5235	*	0340	B
5235	*	0425	B
5235	*	0510	B
5235	*	0595	B
5235	*	0680	B
5235	*	0765	B
5235	*	0850	B
5235	*	0935	B
5235	*	1020	B
5235	*	1105	B
5235	*	1190	B
5235	*	1275	B
5235	*	1360	B
5235	*	1445	B
5235	*	1530	B

Version C - With 2 Positioners

Series	Material	Width	Version
5235	*	0255	C
5235	*	0340	C
5235	*	0425	C
5235	*	0510	C
5235	*	0595	C
5235	*	0680	C
5235	*	0765	C
5235	*	0850	C
5235	*	0935	C
5235	*	1020	C
5235	*	1105	C
5235	*	1190	C
5235	*	1275	C
5235	*	1360	C
5235	*	1445	C
5235	*	1530	C

Tappeti modulari / Modular belts / Mattenketten

551 LBP

Tappeto Modulare 551 LBP, H=12,7 M=85
 Modular Belt Series 551 LBP, H=12,7 M=85 / Modulare Mattenkette 551 LBP, H=12,7 M=85

CODE STRUCTURE GUIDE (Example)

5234	01	0085	A
Series	*Material	Width	Version

Backflex radius min.: 120 mm

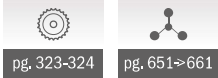

pg. 323-324

pg. 651->661

SAMPLE BOX

Art.-Nr. **5234018888A**

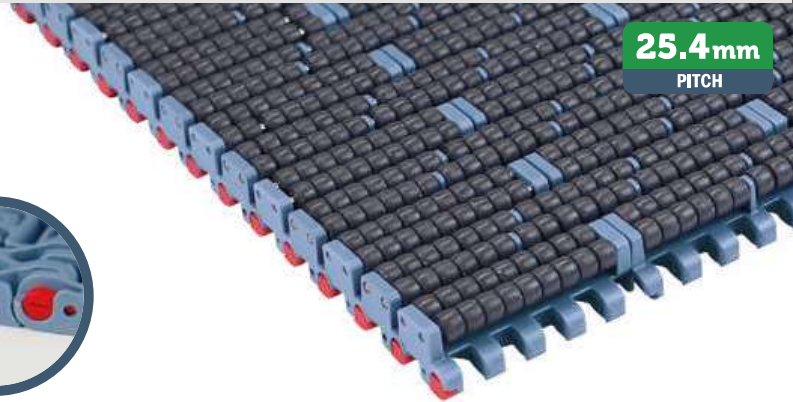

25.4 mm
PITCH

Metric Size

Material

LFA - Code 01 Low friction Acetal

Max w. load: 41500 N/m
 Weight: 26,9 kg/m²
 Temp. range dry: -40+80 °C
 Temp. range wet: -40+65 °C
 Pin material: PBT white

Version A - Standard

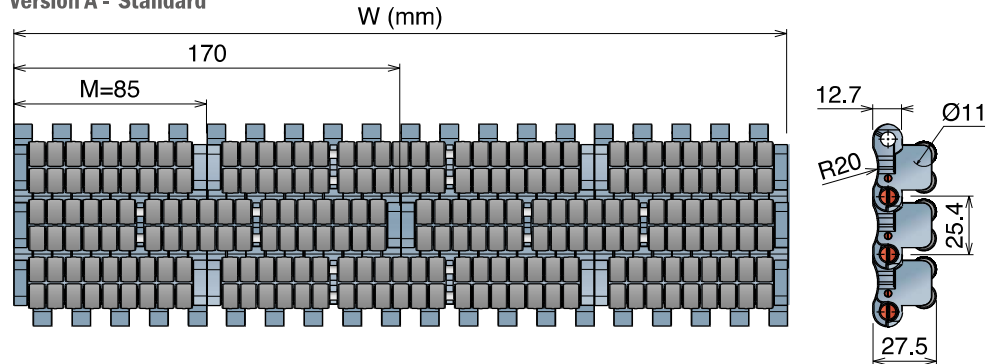

Version B - With 1 Positioner

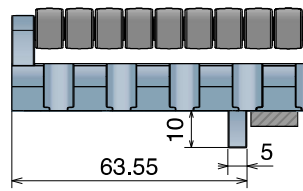

Version C - With 2 Positioners

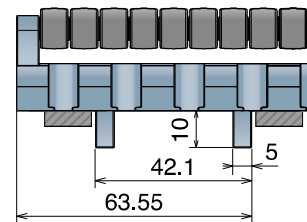

Version A - Standard

Series	Material	Width	Version
5234	01	0085	A
5234	01	0170	A
5234	01	0255	A
5234	01	0340	A
5234	01	0425	A
5234	01	0510	A
5234	01	0595	A
5234	01	0680	A
5234	01	0765	A
5234	01	0850	A
5234	01	0935	A
5234	01	1020	A
5234	01	1105	A
5234	01	1190	A
5234	01	1275	A
5234	01	1360	A
5234	01	1445	A
5234	01	1530	A

Version B - With 1 Positioner

Series	Material	Width	Version
5234	01	0085	B
5234	01	0170	B
5234	01	0255	B
5234	01	0340	B
5234	01	0425	B
5234	01	0510	B
5234	01	0595	B
5234	01	0680	B
5234	01	0765	B
5234	01	0850	B
5234	01	0935	B
5234	01	1020	B
5234	01	1105	B
5234	01	1190	B
5234	01	1275	B
5234	01	1360	B
5234	01	1445	B
5234	01	1530	B

Version C - With 2 Positioners

Series	Material	Width	Version
5234	01	0085	C
5234	01	0170	C
5234	01	0255	C
5234	01	0340	C
5234	01	0425	C
5234	01	0510	C
5234	01	0595	C
5234	01	0680	C
5234	01	0765	C
5234	01	0850	C
5234	01	0935	C
5234	01	1020	C
5234	01	1105	C
5234	01	1190	C
5234	01	1275	C
5234	01	1360	C
5234	01	1445	C
5234	01	1530	C

551 PRO LBP

Tappeti modulari / Modular belts / Mattenketten

PATENTED

Belts wider than standard are available with 85 mm increments

551 PRO LBP

Tappeto Modulare 551 PRO LBP, H=12,7 M=85

Modular Belt Series 551 PRO LBP, H=12,7 M=85 / Modulare Mattenkette 551 PRO LBP, H=12,7 M=85

CODE STRUCTURE GUIDE (Example)

Backflex radius min.: 100 mm

5240	01	0085	A
Series	*Material	Width	Version

	
pg. 323-324	pg. 651->661

SAMPLE BOX

Art.-Nr. **524001888A**



25.4 mm
PITCH

Metric Size

Material

LFA - Code 01

Low friction Acetal

Easy Delivery

Max w. load: 41500 N/m
 Weight SS pin: 13,8 kg/m²
 Weight Plastic pin: 11,0 kg/m²
 Temp. range dry: -40+80 °C
 Temp. range wet: -40+65 °C
 Pin material: PBT white

PFX Roller

**THE BEST CHOICE TO REACH
THE LOWEST FRICTION**

Version A - Standard

W (mm)

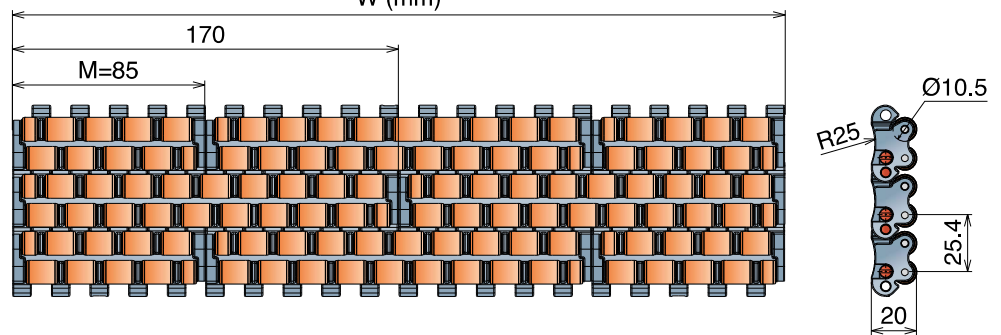

Version B - With 1 Positioner

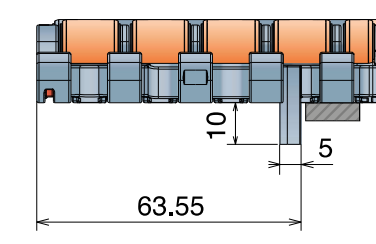

Version C - With 2 Positioner

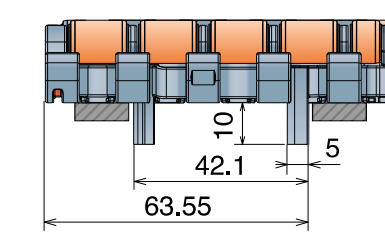

 **Stainless steel Pin**

 **Plastic Pin**

Series	Material	Width	Version
5239	01	0085	*
5239	01	0170	*
5239	01	0255	*
5239	01	0340	*
5239	01	0425	*
5239	01	0510	*
5239	01	0595	*
5239	01	0680	*
5239	01	0765	*
5239	01	0850	*
5239	01	0935	*
5239	01	1020	*
5239	01	1105	*
5239	01	1190	*
5239	01	1275	*
5239	01	1360	*
5239	01	1445	*
5239	01	1530	*

Series	Material	Width	Version
5240	01	0085	*
5240	01	0170	*
5240	01	0255	*
5240	01	0340	*
5240	01	0425	*
5240	01	0510	*
5240	01	0595	*
5240	01	0680	*
5240	01	0765	*
5240	01	0850	*
5240	01	0935	*
5240	01	1020	*
5240	01	1105	*
5240	01	1190	*
5240	01	1275	*
5240	01	1360	*
5240	01	1445	*
5240	01	1530	*

*Version

Standard	Add A
With 1 Positioner	Add B
With 2 Positioners	Add C

Tappeti modulari / Modular belts / Mattenketten

552

Pitch 25,4 mm
H= 12,7 mm



552 FT
552 FT *One track Belt*
552 FTT
552 PT
552 PT *One track Belt*
552 GT

552 GT *Side indent*

552 FT

Tappeto Modulare 552 FT, H=12,7 M=3"
 Modular Belt Series 552 FT, H=12,7 M=3" / Modulare Mattenkette 552 FT, H=12,7 M=3"

Imperial Size

CODE STRUCTURE GUIDE (Example)

5341	01	0009	A
Series	*Material	Width	Version

Backflex radius min.: 25 mm

	
pg. 325	pg. 651->661

SAMPLE BOX	
Art.-Nr.	5341018888A

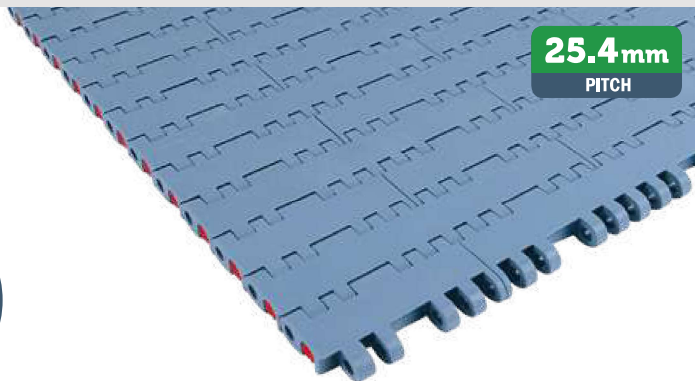
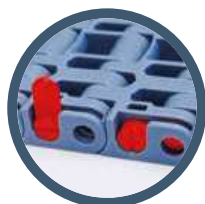

25.4 mm
PITCH

* Material

LFA - Code 01

Low friction Acetal

Easy Delivery

Max w. load: 41500 N/m
Weight: 13,5 kg/m²
Temp. range dry: -40+80 °C
Temp. range wet: -40+65 °C
Pin material: PBT white

MX - Code 03

Performance PBT

Max w. load: 33500 N/m
Weight: 13,0 kg/m²
Temp. range dry: -40+120 °C
Temp. range wet: -40+60 °C
Pin material: POM grey

MWX - Code 17

Polyamide Composite

Max w. load: 41500 N/m
Weight: 14,0 kg/m²
Temp. range dry: -40+104 °C
Temp. range wet: NR
Pin material: PBT white

MPX - Code 25

Lubricated Acetal

Max w. load: 41500 N/m
Weight: 13,5 kg/m²
Temp. range dry: -40+80 °C
Temp. range wet: -40+65 °C
Pin material: PBT white

Version A - Standard

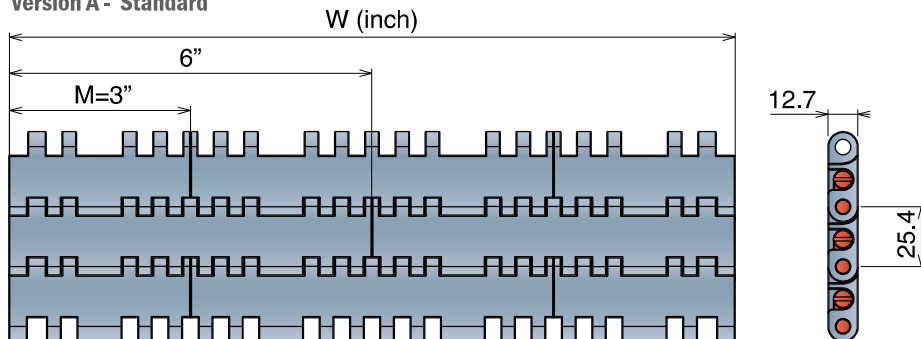

Version A - Standard

Series	Material	Width	Version
5341	*	0009	A
5341	*	0012	A
5341	*	0015	A
5341	*	0018	A
5341	*	0021	A
5341	*	0024	A
5341	*	0027	A
5341	*	0030	A
5341	*	0033	A
5341	*	0036	A
5341	*	0039	A
5341	*	0042	A
5341	*	0045	A
5341	*	0048	A
5341	*	0051	A
5341	*	0054	A

552 FT One track Belt

Tappeto Modulare 552 FT, H=12,7
Modular Belt Series 552 FT, H=12,7 / Modulare Mattenkette 552 FT, H=12,7

CODE STRUCTURE GUIDE (Example)

Backflex radius min.: 25 mm

5341	01	0003	A
Series	*Material	Width	Version

	
pg. 325	pg. 651>661

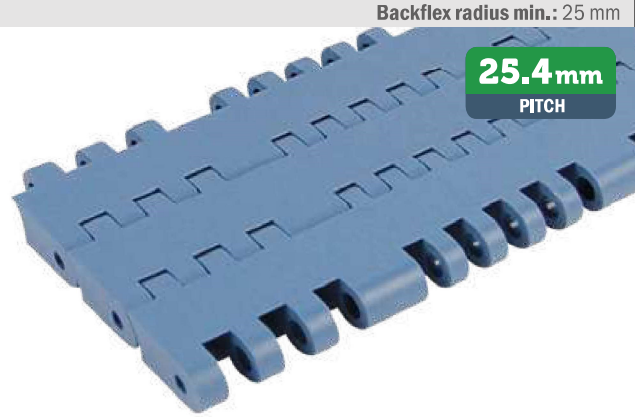

25.4 mm
PITCH



Imperial Size

*Material

LFA - Code 01
Low friction Acetal

Easy Delivery

Max w. load: See below
Weight: 13,5 kg/m²
Temp. range dry: -40÷80 °C
Temp. range wet: -40÷65 °C
Pin material: PBT white

MX - Code 03
Performance PBT

Max w. load: See below
Weight: 13,0 kg/m²
Temp. range dry: -40÷120 °C
Temp. range wet: -40÷60 °C
Pin material: POM grey

MWX - Code 17
Polyamide Composite

Max w. load: See below
Weight: 14,0 kg/m²
Temp. range dry: -40÷104 °C
Temp. range wet: NR
Pin material: PBT white

MPX - Code 25
Lubricated Acetal

Max w. load: See below
Weight: 13,5 kg/m²
Temp. range dry: -40÷80 °C
Temp. range wet: -40÷65 °C
Pin material: PBT white

Max working load (N)

Width	K300	K325	K450
LFA	3200	3400	4800
MX	2500	2800	3800
MWX	3200	3400	4800
MPX	3200	3400	4800

Width	K600	K750
LFA	6200	7900
MX	5100	6400
MWX	6200	7900
MPX	6200	7900

Version A - Standard

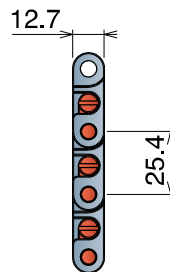
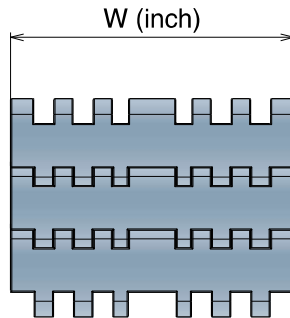

Version C - With 2 Positioner

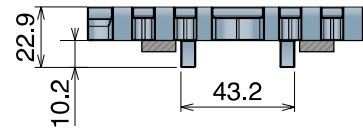

K300 - One track belt



Series	Material	Width	Version
5341	*	0003	A
5341	*	0003	C

K325 - One track belt



Series	Material	Width	Version
5341	*	9325	A
5341	*	9325	C

K450 - One track belt



Series	Material	Width	Version
5341	*	9450	A
5341	*	9450	C

K600 - One track belt



Series	Material	Width	Version
5341	*	0006	A
5341	*	0006	C

K750 - One track belt



Series	Material	Width	Version
5341	*	9750	A
5341	*	9750	C

Tappeti modulari / Modular belts / Mattenketten



552 FTT

Tappeto Modulare 552 FTT, H=12,7
Modular Belt Series 552 FTT, H=12,7 / Modulare Mattenkette 552 FTT, H=12,7

CODE STRUCTURE GUIDE (Example)

Backflex radius min.: 25 mm

5346	01	9450	C-R
Series	*Material	Width	Version

	
pg. 325	pg. 651->661

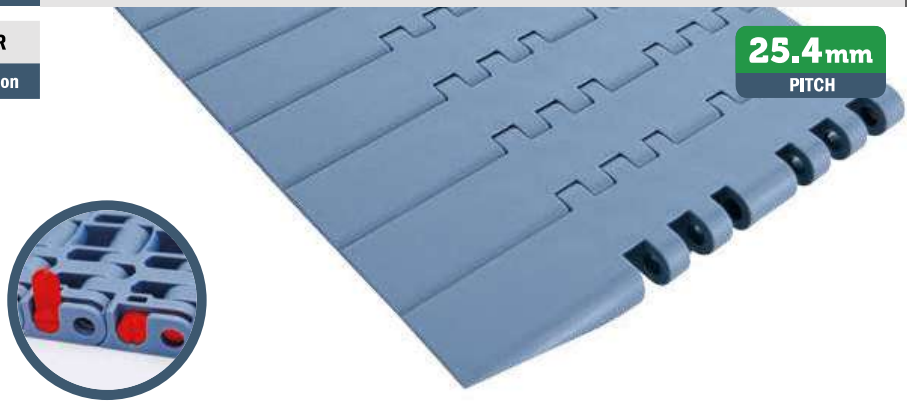

25.4 mm
PITCH



***Material**

LFA - Code 01

Low friction Acetal

Max w. load: See below
Weight: 13,5 kg/m²
Temp. range dry: -40+80 °C
Temp. range wet: -40+65 °C
Pin material: PBT white

MX - Code 03

Performance PBT

Max w. load: See below
Weight: 13,0 kg/m²
Temp. range dry: -40+120 °C
Temp. range wet: -40+60 °C
Pin material: POM grey

MWX - Code 17

Polyamide Composite

Max w. load: See below
Weight: 14,0 kg/m²
Temp. range dry: -40+104 °C
Temp. range wet: NR
Pin material: PBT white

MPX - Code 25

Lubricated Acetal

Max w. load: See below
Weight: 13,5 kg/m²
Temp. range dry: -40+80 °C
Temp. range wet: -40+65 °C
Pin material: PBT white

Max working load (N)

Width	450	750
LFA	4800	7900
MX	3800	6400
MWX	4800	7900
MPX	4800	7900

552 FTT - DX Version

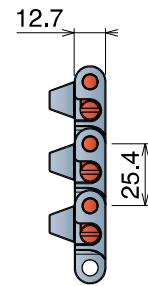
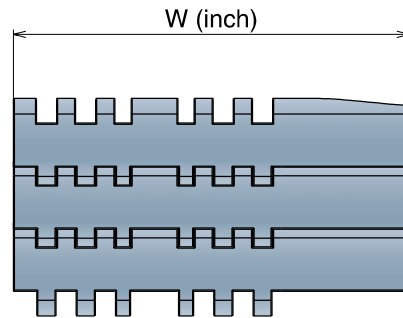
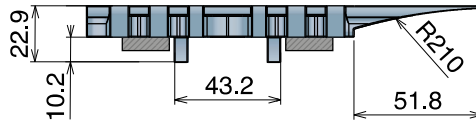

K450 / K750

Series	Material	Width	Version	Total width
5346	*	9450	C - R	160.3
5346	*	9750	C - R	237.4

552 FTT - SX Version

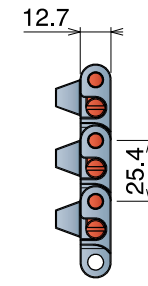
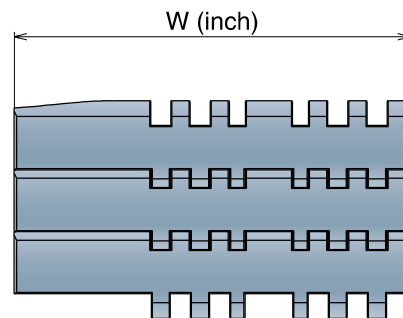
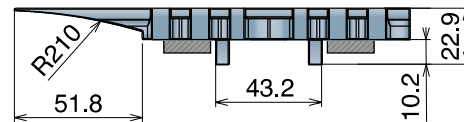

K450 / K750



Series	Material	Width	Version	Total width
5346	*	9450	C - L	160.3
5346	*	9750	C - L	237.4

552 PT Open Surface 8% Tappeto Modulare 552 PT, H=12,7 M=3" Modular Belt Series 552 PT, H=12,7 M=3" / Modulare Mattenkette 552 PT, H=12,7 M=3"

CODE STRUCTURE GUIDE (Example)

Backflex radius min.: 25 mm

5342	01	0009	A
Series	*Material	Width	Version

	
pg. 325	pg. 651->661

SAMPLE BOX

Art.-Nr. **534201888A**

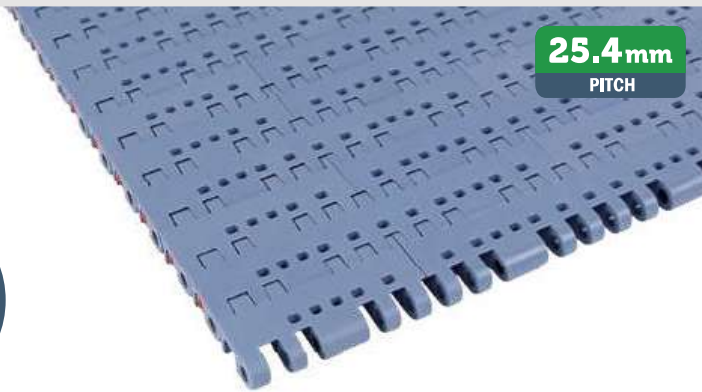

25.4 mm
PITCH

Imperial Size

* Material

LFA - Code 01

Low friction Acetal

Max w. load: 41500 N/m
Weight: 13,2 kg/m²
Temp. range dry: -40+80 °C
Temp. range wet: -40+65 °C
Pin material: PBT white

MX - Code 03

Performance PBT

Max w. load: 33500 N/m
Weight: 12,7 kg/m²
Temp. range dry: -40+120 °C
Temp. range wet: -40+60 °C
Pin material: POM grey

MWX - Code 17

Polyamide Composite

Max w. load: 41500 N/m
Weight: 13,7 kg/m²
Temp. range dry: -40+104 °C
Temp. range wet: NR
Pin material: PBT white

MPX - Code 25

Lubricated Acetal

Max w. load: 41500 N/m
Weight: 13,2 kg/m²
Temp. range dry: -40+80 °C
Temp. range wet: -40+65 °C
Pin material: PBT white

Version A - Standard

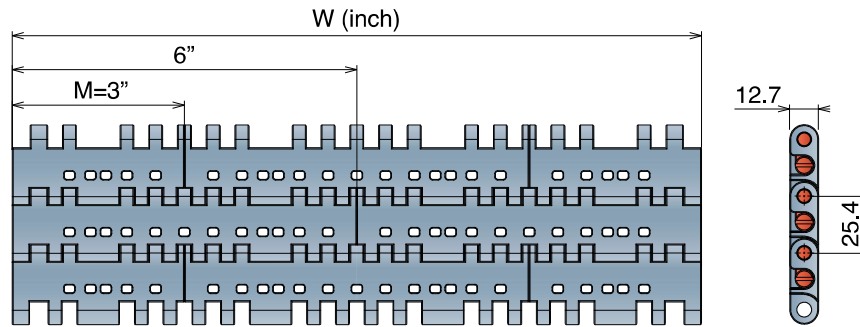

Version A - Standard

Series	Material	Width	Version
5342	*	0009	A
5342	*	0012	A
5342	*	0015	A
5342	*	0018	A
5342	*	0021	A
5342	*	0024	A
5342	*	0027	A
5342	*	0030	A
5342	*	0033	A
5342	*	0036	A
5342	*	0039	A
5342	*	0042	A
5342	*	0045	A
5342	*	0048	A
5342	*	0051	A
5342	*	0054	A

552 PT One track Belt

Tappeti modulari / Modular belts / Mattenketten

552 PT One track Belt Open Surface 8% Tappeto Modulare 552 PT, H=12,7 M=3" / Modular Belt Series 552 PT, H=12,7 M=3" / Modulare Mattenkette 552 PT, H=12,7 M=3"

CODE STRUCTURE GUIDE (Example)

Backflex radius min.: 25 mm

5342	01	0003	A
Series	*Material	Width	Version

	
pg. 325	pg. 651->661

25.4 mm
PITCH

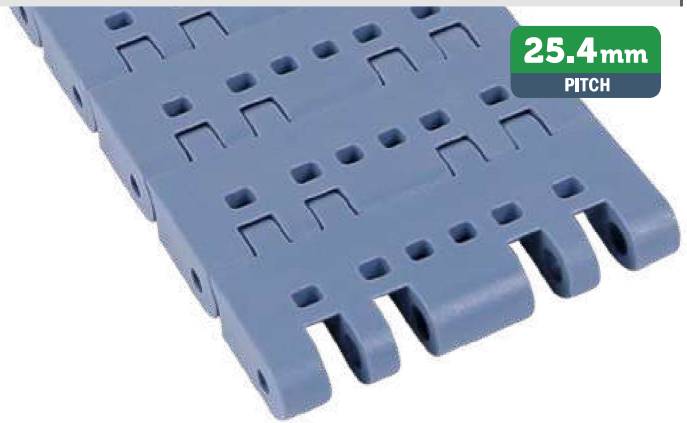

Imperial Size

*Material

LFA - Code 01

Low friction Acetal

Max w. load: See below
Weight: 13,2 kg/m²
Temp. range dry: -40+80 °C
Temp. range wet: -40+65 °C
Pin material: PBT white

MX - Code 03

Performance PBT

Max w. load: See below
Weight: 12,7 kg/m²
Temp. range dry: -40+120 °C
Temp. range wet: -40+60 °C
Pin material: POM grey

MWX - Code 17

Polyamide Composite

Max w. load: See below
Weight: 13,7 kg/m²
Temp. range dry: -40+104 °C
Temp. range wet: NR
Pin material: PBT white

MPX - Code 25

Lubricated Acetal

Max w. load: See below
Weight: 13,2 kg/m²
Temp. range dry: -40+80 °C
Temp. range wet: -40+65 °C
Pin material: PBT white

Max working load (N)

Width	300	600
LFA	3200	6300
MX	2500	5100
MWX	3200	6300
MPX	3200	6300

Version A - Standard

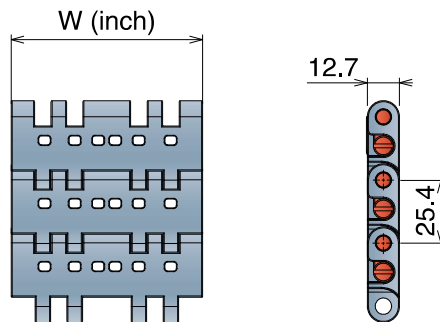

Version C - With 2 Positioner

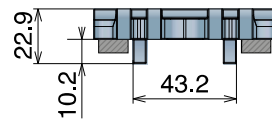

Version A - Standard

Series	Material	Width	Version
5342	*	0003	A
5342	*	0006	A

Version C - With 2 Positioners

Series	Material	Width	Version
5342	*	0003	C
5342	*	0006	C

Tappeti modulari / Modular belts / Mattenketten

552 GT

Tappeto Modulare 552 GT, H=12,7 M=3"
 Modular Belt Series 552 GT, H=12,7 M=3" / Modulare Mattenkette 552 GT, H=12,7 M=3"

CODE STRUCTURE GUIDE (Example)

Backflex radius min.: 25 mm

5343	01	0009	A
Series	*Material	Width	Version

	
pg. 325	pg. 651->661

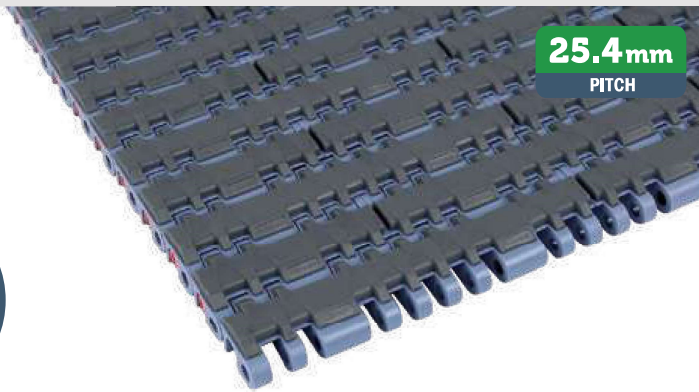

25.4 mm
PITCH

Imperial Size

*Material

LFA - Code 01 Low friction Acetal

Max w. load: 41500 N/m
 Weight: 15,5 kg/m²
 Temp. range dry: -40+80 °C
 Temp. range wet: -40+65 °C
 Pin material: PBT white
 Top rubber: 50 ShA-Dark grey

PP - Code 02 Polypropylene

Max w. load: 27000 N/m
 Weight: 13,5 kg/m²
 Temp. range dry: 4+80 °C
 Temp. range wet: 4+80 °C
 Pin material: PP blue
 Top rubber: 50 ShA-Black

Version A - Standard

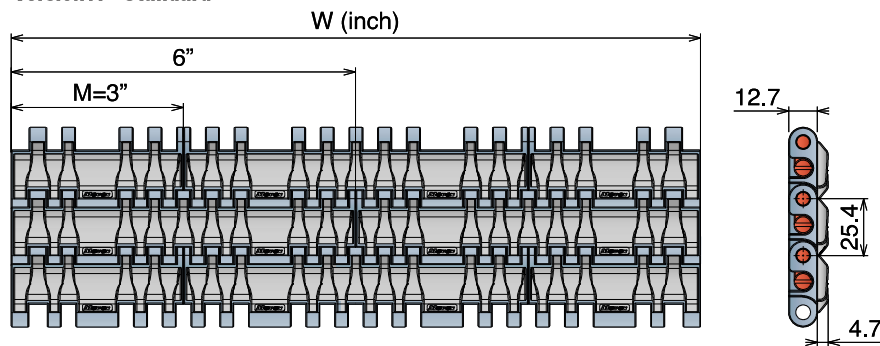

Version A - Standard

Series	Material	Width	Version
5343	*	0009	A
5343	*	0012	A
5343	*	0015	A
5343	*	0018	A
5343	*	0021	A
5343	*	0024	A
5343	*	0027	A
5343	*	0030	A
5343	*	0033	A
5343	*	0036	A
5343	*	0039	A
5343	*	0042	A
5343	*	0045	A
5343	*	0048	A
5343	*	0051	A
5343	*	0054	A



Rubber Thickness 4.7 mm

Tappeti modulari / Modular belts / Mattenketten

552 GT Side indent

Tappeti modulari / Modular belts / Mattenketten

Belts wider than standard are available with 3 inch increments

552 GT Side indent Tappeto Modulare 552 GT SI, H=12,7 M=3" / Modulare Mattenkette 552 GT SI, H=12,7 M=3"

CODE STRUCTURE GUIDE (Example)

Backflex radius min.: 25 mm

5345	01	0009	A
Series	*Material	Width	Version

	
pg. 325	pg. 651->661

25.4 mm
PITCH

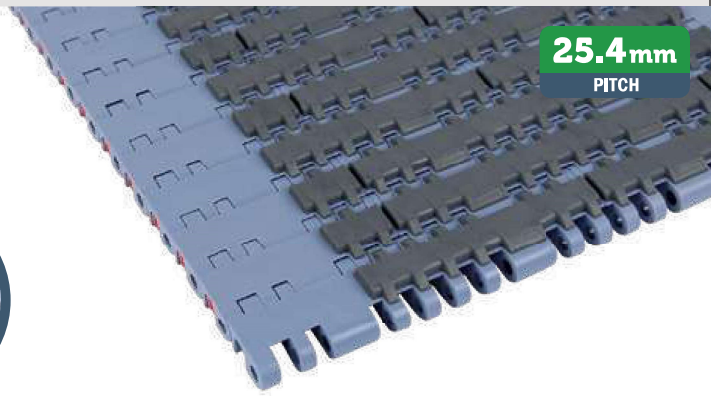

Imperial Size

*Material

LFA - Code 01

Low friction Acetal

Max w. load: 41500 N/m
Weight: 15,5 kg/m²
Temp. range dry: -40+80 °C
Temp. range wet: -40+65 °C
Pin material: PBT white
Top rubber: 50 ShA-Dark grey

PP - Code 02

Polypropylene

Max w. load: 27000 N/m
Weight: 13,5 kg/m²
Temp. range dry: 4+80 °C
Temp. range wet: 4+80 °C
Pin material: PP blue
Top rubber: 50 ShA-Black

Version A - Standard

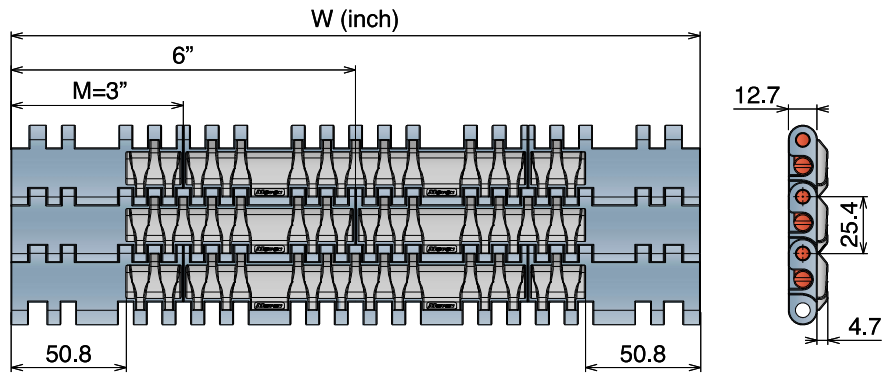

Version A - Standard

Series	Material	Width	Version
5345	*	0009	A
5345	*	0012	A
5345	*	0015	A
5345	*	0018	A
5345	*	0021	A
5345	*	0024	A
5345	*	0027	A
5345	*	0030	A
5345	*	0033	A
5345	*	0036	A
5345	*	0039	A
5345	*	0042	A
5345	*	0045	A
5345	*	0048	A
5345	*	0051	A
5345	*	0054	A



Rubber Thickness 4.7 mm

Tappeti modulari / Modular belts / Mattenketten

553

Pitch 25,4 mm

H= 8,7 mm

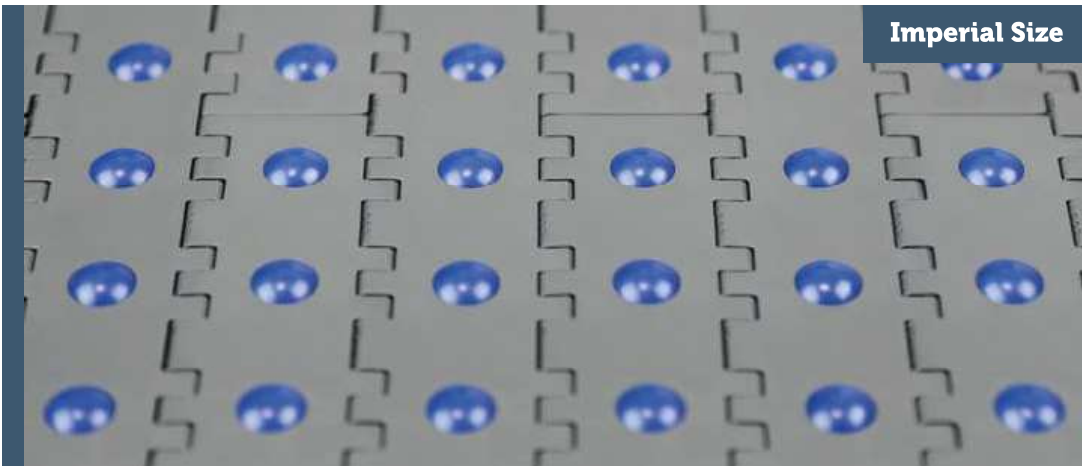

Imperial Size

553 FLEXTOP

NEW 553 FLEX TOP Tappeto Modulare 553 FLEXTOP, H=8,7 M=3"
Modular Belt Series 553 FLEXTOP, H=8,7 M=3" / Modulare Mattenkette 553 FLEXTOP, H=8,7 M=3"

Backflex radius min.: 25 mm

Imperial Size

The new **Movex® 553 FlexTop** modular belt with self-locking spheres is specifically designed for high-precision material handling, suitable for several applications like logistic centers, packaging stations (food and beverage) and corrugated industries, easily to be integrated into existing systems. The 360° movement possibility makes the belt suitable for diverting, rotation, accumulation and acceleration applications and minimize required maintenance and downtimes. The small pitch between the spheres allows every type of product transfer and is ideal for small and light packages, unlike traditional roller conveyors.

The complete closed sliding belt surface is the perfect solution to carry carton boxes, crates, cans and bottles shrink-wrap packaging and any kind of polybag with Top-Accuracy package control. **553 FlexTop is best choice for material handling applications!**

High strength

Design and features of 553 FlexTop make it ideal for the transport of several type of products (e.g. polybags, shrink-wrap packaging).

Perfect product control

The small pitch between the spheres allows for a great product-control.

Self cleaning

A complete closed sliding surface, in combination with self-locking spheres, makes the belt design flexible and robust.

Great versatility

The directional belt underneath the flextop belt controls the direction and the speed of the spheres, making this belt 100% versatile.

Long durability

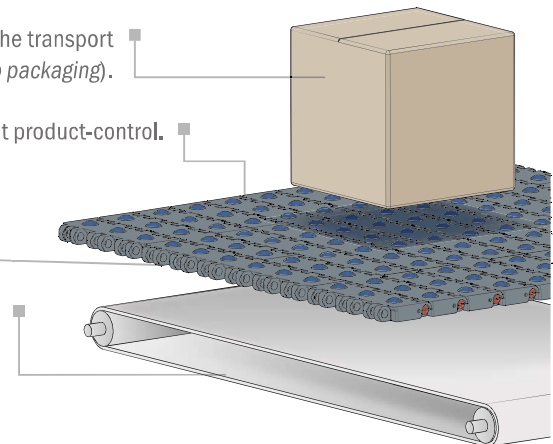

DIVERTING

Side movement

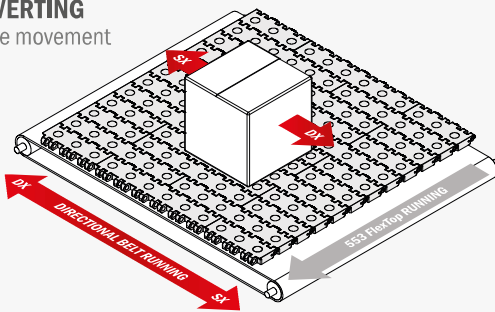

By using a directional belt underneath the Flextop belt, running square to the travel direction, the product can be transferred left and right.

ROTATION

Product stop

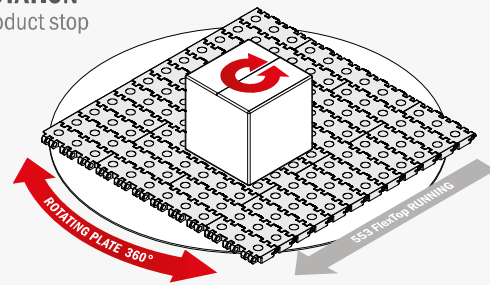

By using a rotating plate underneath the Flextop belt, sphere can rotate by 360°. This option can be used with product stopped or running on the belt, to easily positioning the product.

DINAMIC ROTATION

Product moving

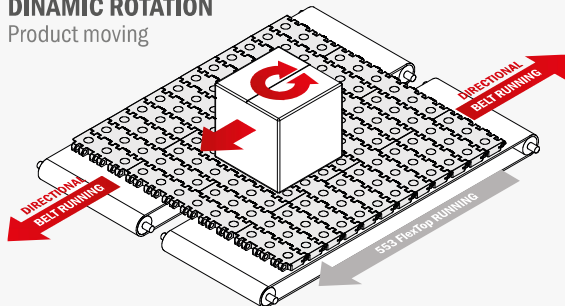

By using two auxiliary belts underneath the Flextop belt, running at opposite direction, the product will start rotating. With this option the Flextop belt can keep running.

ACCELERATION

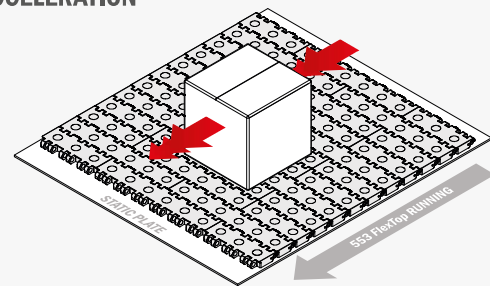

By using a static plate underneath the Flextop belt, spheres will start rotating independently, so the speed of the product will result double than the speed of the belt itself.

PATENTED

Belts wider than standard are available with 3 inch increments

553 FLEX TOP

Tappeti modulari / Modular belts / Mattenketten

NEW

553 FLEX TOP Tappeto Modulare 553 FLEXTOP, H=8,7 M=3"

Modular Belt Series 553 FLEXTOP, H=8,7 M=3" / Modulare Mattenkette 553 FLEXTOP, H=8,7 M=3"

CODE STRUCTURE GUIDE (Example)

Backflex radius min.: 25 mm

5530	27	0003	A
Series	*Material	Width	Version

	553 Sorter+	
pg. 326	pg. 301	pg. 651⇒661

SAMPLE BOX

Art.-Nr. **5530018888A**



Imperial Size

* Material

LFG - Code 27
Low friction Acetal

Max w. load: 27500 N/m
Weight: 10,0 kg/m²
Temp. range dry: -40+80 °C
Temp. range wet: -40+65 °C
Pin material: PBT white

Sphere Material

High-tech polyamide

Max w. load: 15 N
Sphere diameter: 12,7 mm

Version A - Standard

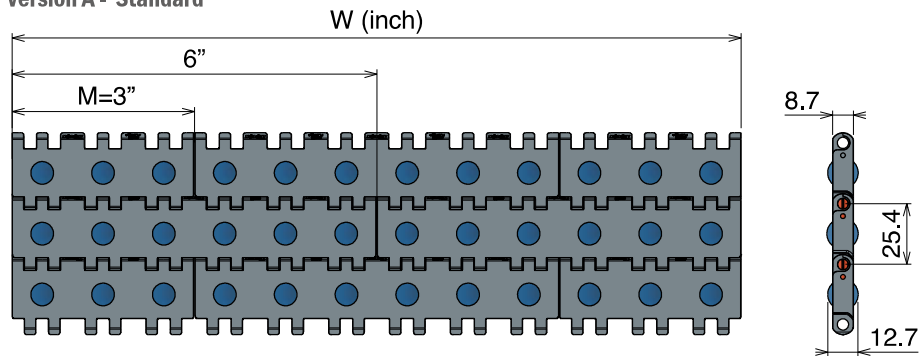

Version A - Standard

Series	Material	Width	Version	Series	Material	Width	Version
5530	*	0003	A	5530	*	0060	A
5530	*	0006	A	5530	*	0063	A
5530	*	0009	A	5530	*	0066	A
5530	*	0012	A	5530	*	0069	A
5530	*	0015	A	5530	*	0072	A
5530	*	0018	A	5530	*	0075	A
5530	*	0021	A	5530	*	0078	A
5530	*	0024	A	5530	*	0081	A
5530	*	0027	A	5530	*	0084	A
5530	*	0030	A	5530	*	0087	A
5530	*	0033	A	5530	*	0090	A
5530	*	0036	A	5530	*	0093	A
5530	*	0039	A	5530	*	0096	A
5530	*	0042	A	5530	*	0099	A
5530	*	0045	A	5530	*	0102	A
5530	*	0048	A	5530	*	0105	A
5530	*	0051	A	5530	*	0108	A
5530	*	0054	A	5530	*	0111	A
5530	*	0057	A	5530	*	0114	A

Continue >>



PATENTED CLOSED GAP

Patented closed gap helps reducing maintenance frequency and increasing productivity.

Tappeti modulari / Modular belts / Mattenketten

500

Pitch 50,8 mm
H= 24 mm



500 RR
500 RR *with positioner*
389 *Combs*

Movex[®]

500 Series

500 RR

Tappeto Modulare 500 RR
Raised Rib Belt Series 500 RR / Modulare Mattenkette 500 RR

CODE STRUCTURE GUIDE (Example)

1348	02	0060
Series	*Material	Width

	
pg. 333-334	pg. 651-661



50.8mm
PITCH

*Material

PP - Code 02
Polypropylene

PPX - Code 11
Polypropylene

Max w. load:	30000 N/m	Max w. load:	30000 N/m
Weight:	10,65 kg/m ²	Weight:	10,65 kg/m ²
Temp. range:	4+104 °C	Temp. range:	4+104 °C

Pin material: PP grey **Pin material:** PP grey

IMPROVED HEAT STABILITY

Series	Material	Width
1348	*	0060
1348	*	0063
1348	*	0066
1348	*	0069
1348	*	0072
1348	*	0075
1348	*	0078
1348	*	0081
1348	*	0084
1348	*	0087
1348	*	0090
1348	*	0093
1348	*	0096
1348	*	0099
1348	*	0102
1348	*	0105
1348	*	0108
1348	*	0111
1348	*	0114
1348	*	0117
1348	*	0120

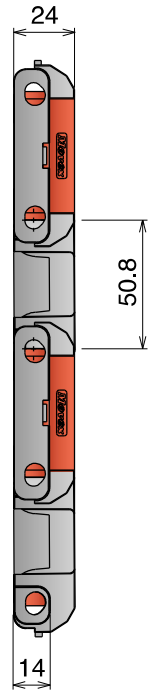
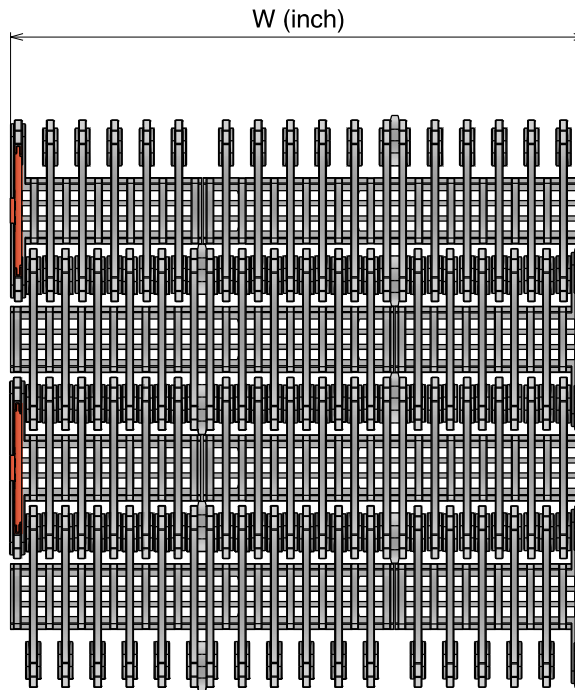

Imperial Size

Tappeti modulari / Modular belts / Mattenketten

500 RR with positioner



Tappeti modulari / Modular belts / Mattenketten

Belts wider than standard are available with 3 inch increments

NEW 500 RR with positioner Tappeto Modulare 500 RR Raised Rib Belt Series 500 RR / Modulare Mattenkette 500 RR

CODE STRUCTURE GUIDE (Example)

1348	02	0060	C
Series	*Material	Width	Version

	
pg. 333-334	pg. 651->661



Imperial Size

*Material

PP - Code 02
Polypropylene

PPX - Code 11
Polypropylene

Max w. load:	30000 N/m	Max w. load:	30000 N/m
Weight:	10,65 kg/m ²	Weight:	10,65 kg/m ²
Temp. range:	4+104 °C	Temp. range:	4+104 °C

Pin material: PP grey **Pin material:** PP grey

IMPROVED HEAT STABILITY

Series	Material	Width	Version
1348	*	0060	C
1348	*	0063	C
1348	*	0066	C
1348	*	0069	C
1348	*	0072	C
1348	*	0075	C
1348	*	0078	C
1348	*	0081	C
1348	*	0084	C
1348	*	0087	C
1348	*	0090	C
1348	*	0093	C
1348	*	0096	C
1348	*	0099	C
1348	*	0102	C
1348	*	0105	C
1348	*	0108	C
1348	*	0111	C
1348	*	0114	C
1348	*	0117	C
1348	*	0120	C

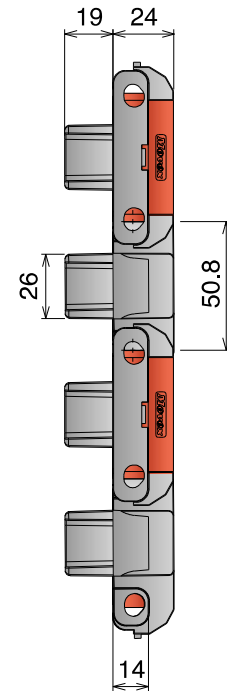
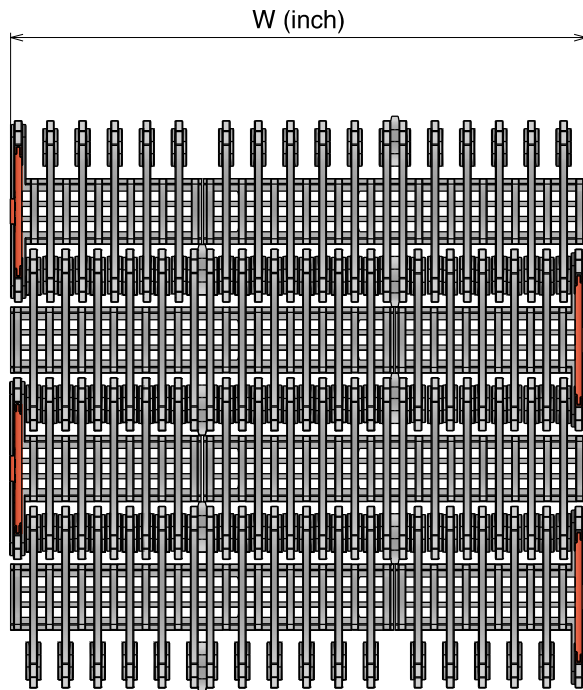

Bottom view

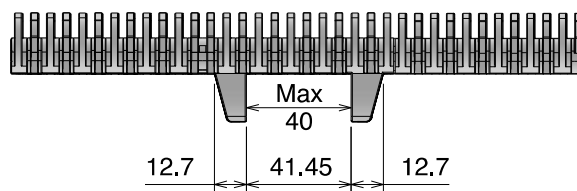

For belt widths multiple of 3", positioners are centered (e.g. 63,69,75,81 inches).
For belt widths multiple of 6", positioners are 1,5" offset (e.g. 60,66,72,78 inches).

Tappeti modulari / Modular belts / Mattenketten

389 Pettine Combs / Fingerplatte



Two screw included

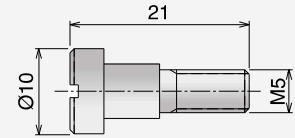

For assembly instructions refers to Movex engineering manual available on our website.

Type A

Part	Article-Nr.
389	38901

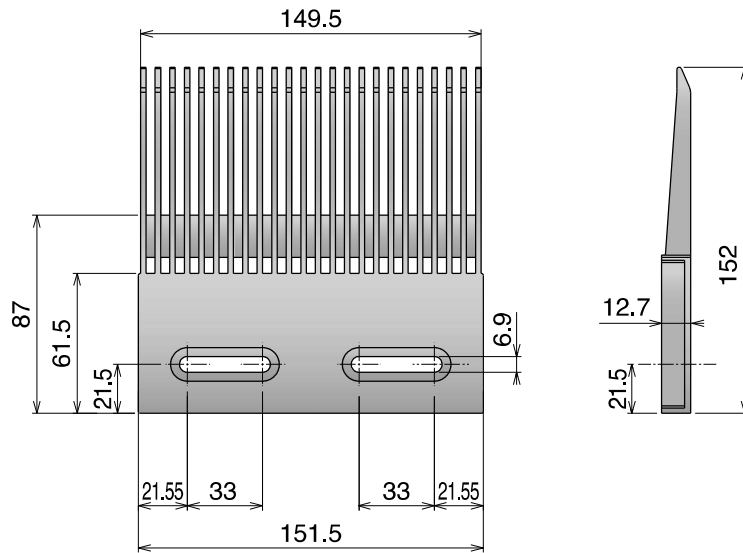

Type B

Part	Article-Nr.
389	38902

