

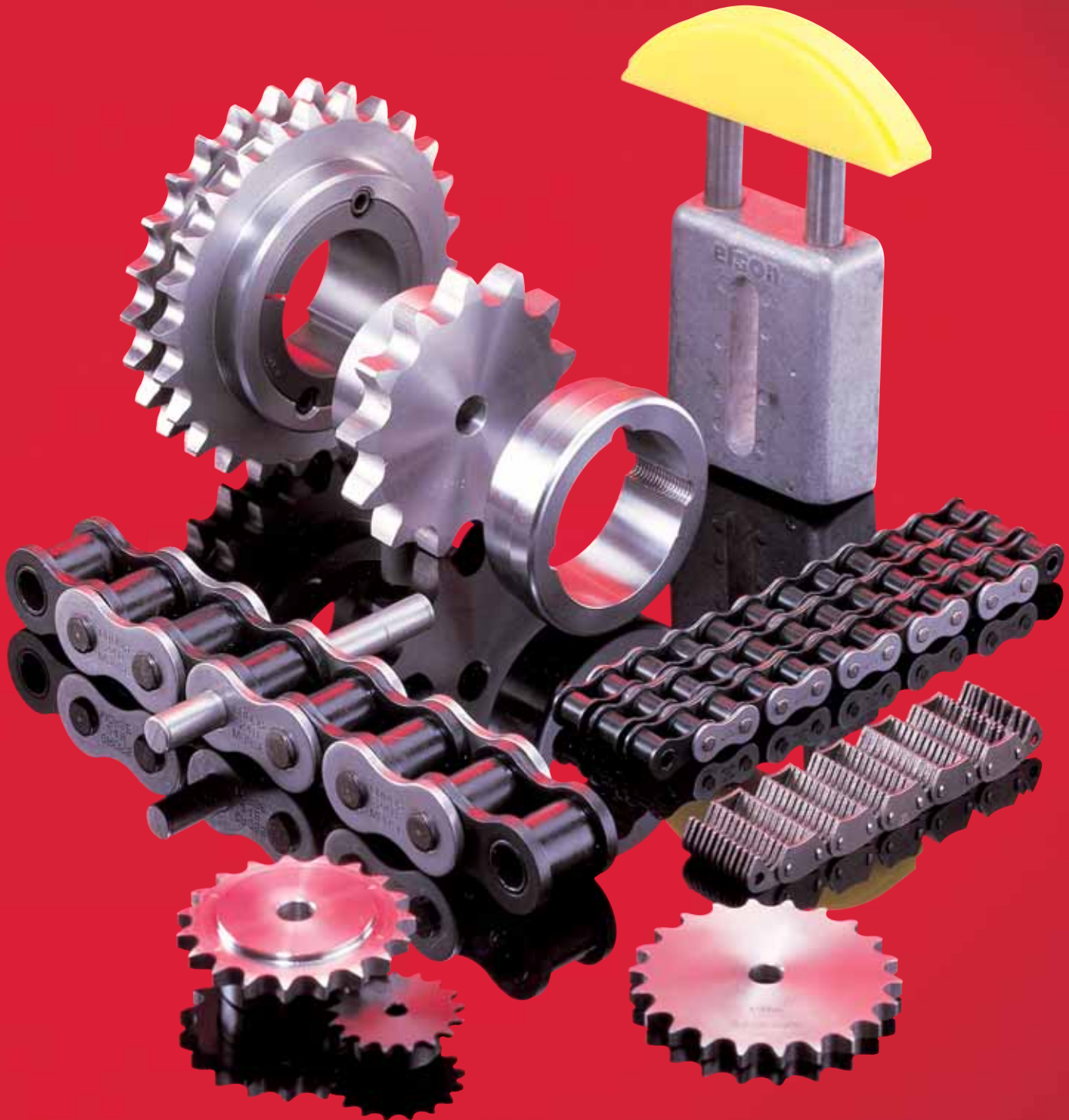

Power Transmission Solutions



Transmissions Catalogue



The Company

Cross & Morse was established in 1984 through the amalgamation of two long standing and well respected companies in the Power Transmission Industry, T.D. Cross and Morse Chain.

T.D. Cross & Sons was founded in 1870 in Birmingham, concentrating in the production of bicycle components under the direction of the Cross family. They moved to the current factory site in 1950 and developed into production of a popular range of roller chain sprockets and gearing.

The Morse Chain Company was founded in 1894 also for the manufacture of bicycles in Pennsylvania, U.S.A. The company moved into production of inverted tooth chain drives and established a manufacturing plant in London in 1907, moving to the new Garden City of Letchworth, Herts. in 1918. The product range in the U.K. was developed to include Roller Chain and Sprockets, Couplings, Torque Limiters, Sprag Clutches and Timing Belt Drives, whilst in the U.S.A. by acquisition Morse also included the Sealmaster Bearing Products.

In 1987 Cross & Morse closed the Letchworth plant and centralised all production at the 10,000 sq. metre factory in Great Barr, Birmingham where current production of Roller Chains, Sprockets, Gears, Timing Belt Pulleys, Torque Limiters, Sprag Clutches and other specialised power transmission equipment is undertaken. In addition to manufactured products, Cross & Morse are main agents for Morse-Emerson, U.S.A.; providing an extensive range of power transmission products.

The company has in recent years expanded its markets into new areas which include food processing and pharmaceutical industries.

The company operates a policy of continued assessment to develop and improve its products and customer service. In pursuance of these objectives Cross & Morse has been successfully assessed as an approved manufacturer of power transmission products to BS EN ISO 9001.

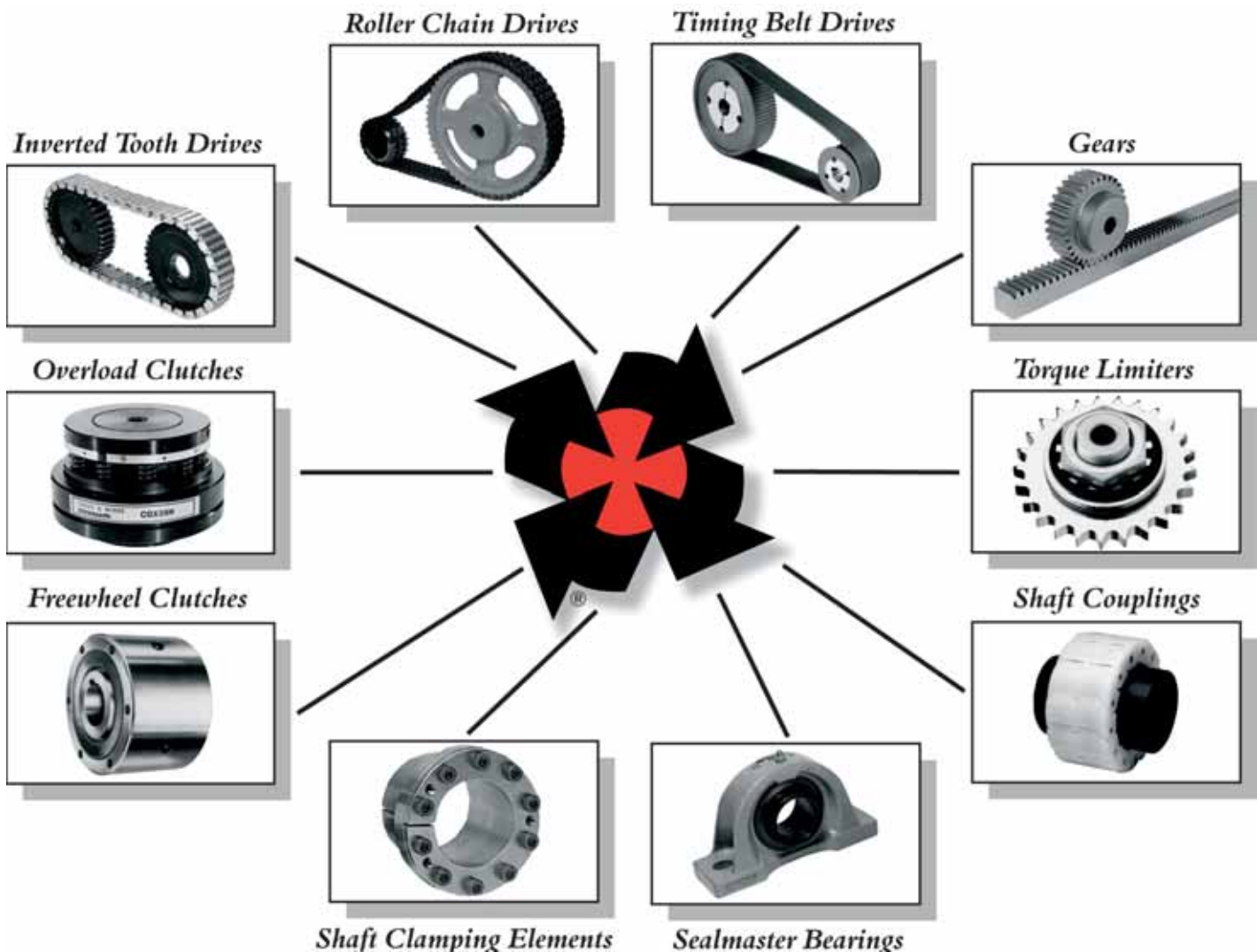

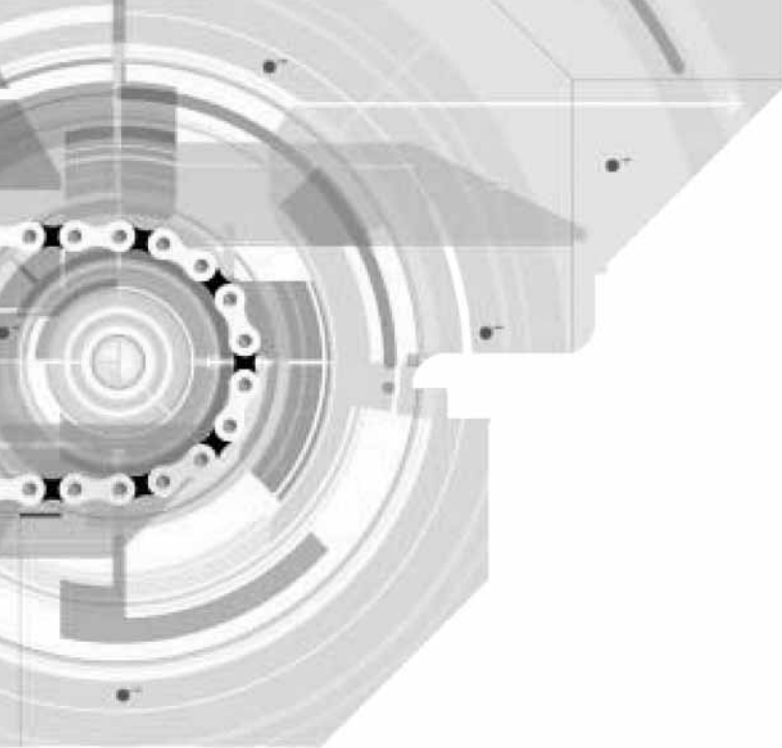

Power Transmission Solutions

Tel +44(0) 121 360 0155

Fax +44(0) 121 325 1079

Email sales@crossmorse.com

INDEX

Cross & Morse Chain Drive Products	2-3	- 1.1/2" pitch (24B)	67
American Standard:		- 1.3/4" pitch (28B)	68
- ANSI Chains	20-21	- 2" pitch (32B)	68
- Attachment Chains	22-23	Platowheel Adaptor Hubs	69-70
- Double Pitch Chains	25-27	Rivet Extractors	37
- Maintenance-Free Chains	24	Roller Chain - Cross+Morse Specification:	4
- Stainless Steel Chains	28	- Drive Design	5-6
British Standard:		- Drive Selection	7-9
- Attachment Chains	16-17	- Installation	13
- Chains ISO 606	14	- Lubrication	12
- Double Pitch Chains	15	- Selection Graphs	10-11
- Spl Construction Chains	15	Roller Chain Sprockets:	
- Stainless Steel Chains	18	- Custom Design	31
- Corrosion Resistant Roller Chains	18	- Design Data	31
- Stainless Steel Roller Chain Attachments	19	Sintered Bush Chain	24
Centre Distance Calculations	9	Sprockets:	
Chain Drive Ratios	8	- American Standard Chains	57-58
Chain Tensioners	71-75	- Double Simplex - Pilot Bore	55
Drive Design Data	94	- Double Simplex - Taper Bore	56
Food Processing Chains	29	- Original T.D. Cross & Sons Design	53-54
Formulae - Conversion Factors	94	Sprockets - Pilot Bore:	
Idler Sprockets	70	- 8mm pitch (05B)	40
Inverted Tooth Chain & Sprockets		- 3/8" pitch (06B)	41
- Conveyor Chains	90	- 1/2" narrow	42
- Design & Selection	76-78	- 1/2" pitch (08B)	43
HV Sprockets		- 5/8" pitch (10B)	44
- Dimensions	81-82	- 3/4" pitch (12B)	45
- Installation	83	- 1" pitch (16B)	46
- Serpentine Chains	89	- 1.1/4" pitch (20B)	47
- Type HV	76-82	- 1.1/2" pitch (24B)	48
- Type SC	84-87	- 1.3/4" pitch (28B)	49
- RKH Metric Chain	88	- 2" pitch (32B)	50
- Duplex SC and RP	89	Sprockets - Stainless Steel	51-52
Keyway Dimensions	95	Sprockets - Taper Bore:	
'O' Ring Chains	24	- 3/8" pitch (06B)	32
Platowheels:		- 1/2" pitch (08B)	33
- 8mm pitch (05B)	59	- 5/8" pitch (10B)	34
- 3/8" pitch (06B)	60	- 3/4" pitch (12B)	35
- 1/2" narrow	61	- 1" pitch (16B)	36
- 1/2" pitch (08B)	62	- 1.1/4" pitch (20B)	37
- 5/8" pitch (10B)	63	Taper Bushes	38-39
- 3/4" pitch (12B)	64	Tensioners	71-75
- 1" pitch (16B)	65	Thermoplastic Roller Chain	24
- 1.1/4" pitch (20B)	66	Triple Speed Conveyor Chain	28

Power Transmission Product Range



www.crossmorse.com
Email sales@crossmorse.com
Fax +44(0) 121 325 1079
Tel +44(0) 121 360 0155

The Power Transmission Spectrum

Cross+Morse manufacture and supply a complete line of drives to meet the challenge of modern industry, where ever increasing powers, and speeds are required in production machinery combined with precision timing.

Cross+Morse offer:-

- Roller Chain** - for high torque drives at low to moderate speeds.
- Silent Chain** - for smooth, quiet, medium power drives at higher speeds
- HV Chain** - for maximum power transmission on high speed drives
- Timing Belts** - for light weight, low cost transmissions from medium to very high speeds
- Gears** - for compact centres and right angle drives.

The graph alongside shows a typical power comparison between drives of a similar size. Gears are excluded, as by design they can be manufactured to accommodate a wide range of power and speed combination.

Roller power curve climbs straight and rapidly to a peak in shaft speeds typical of electric motors and gas engines. HV chain picks up after Roller Chain has reached its peak, and continues to provide more than twice power capacity at speeds typical of gas turbines and high speed internal combustion engines. Silent chain offers a compromise for moderate power drives where speed is beyond roller chain, or where a low noise level and smooth drive are required. The timing belt power curve is much lower than chain drives, but continues on to shaft speeds beyond the limit of chain capabilities, offering compact low cost drives.

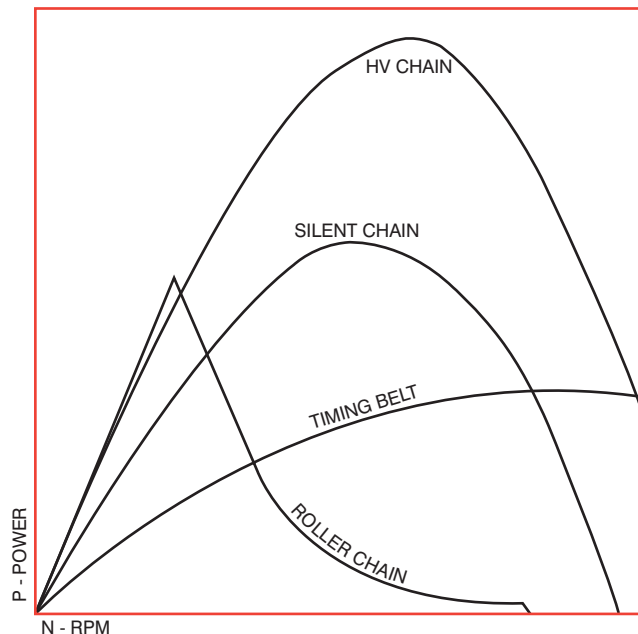

The Product Range

Precision Roller Chain

Cross+Morse manufacture and supply Precision Roller Chain to ISO Standards types A (ANSI Std) and type B (BS Series) over a pitch range 1/4" to 3" in simplex and multi-strand forms. These chains can transmit from fractional powers to over 2,500 kW with chain speeds up to 25 m/s. Roller Chains offer a number of design advantages.

Flexibility of Design

Maximum freedom in selection of shaft centre distances, fixed, or adjustable. Symmetrical design permits engagement with sprocket from either side of chain. Will drive several shafts in either direction from a single shaft. Environmental conditions are not normally critical, and then chain can be simply modified for extreme conditions. In addition to power transmission applications roller chain is frequently used for the transportation of product in conveying applications. A range of attachment plates, and extended pins are normally used with the standard chain on these applications. For longer centre conveyors, double pitch conveying chains are available.

Durability

When the chain wraps around the sprocket, the load is distributed over many pitches so pressures are comparatively low for the power transmitted. The wearing parts are made of high grade, hardened steel. Properly selected and installed, precision roller chain will withstand short term overloads and shock loads, giving long service life.

Efficiency

The positive action of precision roller chain is highly efficient throughout the life of the drive without power loss due to slippage, providing efficiencies of up to 98.5%.

Convenience

Roller chain drive selection is simple and direct. Installation, including centre distance tolerances, does not require the accuracy of other power transmission media. Roller chains can be easily connected or disconnected by standard connecting links; there is no need to disturb sprockets, shafts or bearings to replace chain.

Availability with Low Cost

A very large range of complete standard drives ensures early delivery of drives to suit most installations. Standardisation provides low cost, interchangeability, and availability at all times. For many applications Precision Roller Chain provides the lowest cost solution to drive requirements, with minimal maintenance requirements.

Sprockets and Drive Accessories

A comprehensive range of pilot bored sprockets, chain wheels, and platewheels is available from stock, all of which can be supplied modified to suit customers shafting. For the more popular BS Chain sizes, taper bored sprockets are also available. To complete the drive is a range of self adjusting and rigid tensioners.

Pilot bore sprockets and chainwheels for BS Chains, 05B-1 (8mm) to 32B-3 (2").

Pilot bore sprockets for ANSI Chains, ANSI 35 ($\frac{3}{8}$ ") to ANSI 80 (1").

Stainless steel pilot bore sprockets for BS Chains 06B-1 ($\frac{3}{8}$ ") to 16B-1 (1").

Pilot bore platewheels for BS Chains 06B-1 ($\frac{3}{8}$ ") to 32B-3 (2").

Taper bore sprockets and bushes for BS Chains 06B-1 ($\frac{3}{8}$ ") to 20B-1 (1 $\frac{1}{4}$ ").

Double simplex sprockets for BS Chains 06B-1 to 16B-1.

Idler sprockets for BS Chains 06B-1 to 20B-1.

Spring loaded tensioners and rigid chain adjusters for $\frac{3}{8}$ " to 1 $\frac{1}{2}$ ".

HV Inverted Tooth Chain

Morse HV Chain is ideal for applications where high powers, 30 to 3000 kW, are to be transmitted at moderate to high shaft speeds, 500 to 12,000 r.p.m., and where compact design is required. Offered in 6 pitch sizes and a selection of widths, HV is a highly refined inverted tooth chain providing the smoothness of a belt drive with the compactness, economy, and durability of chain drives. Drive efficiencies of up to 99.7% can be obtained with HV Chain.

HV features a pin and rocker joint which, through its rolling action, reduces friction and provides pitch compensation. The result is reduction of damaging chordal action and a significant increase in horsepower capacity. HV links have more metal at the aperture, a lower crotch, and are shot peened and pre-stressed for greater load carrying capacity.

HV offers three times the power capacity of standard silent chain over a greater speed range. At higher speeds where roller chain capacity drops off rapidly, HV chain powers continue to increase peaking at chain speeds over 30m/s.

HV capacity is ideal for all power transmission requirements involving high speed prime movers such as diesel engines or gas turbines.

Morse HV is the best buy for high capacity, high speed mechanical power transmission.

Silent Chain

'SC' series silent chains are available from $\frac{3}{16}$ " to 2" pitch in a selection of standard width sizes. All chains conform to ANSI B 29.2 and B 29.9 Standard ensuring total interchangeability.

For all chains except $\frac{3}{16}$ " pitch SC chain uses the special HV series pin an rocker joint providing optimum pitch compensation and reduced friction, enabling higher loads and speeds to be accommodated and compared to competitive chains.

For $\frac{3}{16}$ " pitch chain a round pin design is used to assist in manufacture, and increase flexibility for lower power drives. The round pin design is also used for double sided chains $\frac{1}{2}$ " and $\frac{3}{4}$ " pitch to enable full backbending.

Cross+Morse Roller Chain Drives



Cross+Morse manufacture and stock a comprehensive range of Precision Roller Chain Drives, conforming to both British Standard (BS) and American Standard (ANSI) dimensions within ISO 606; in pitch sizes from 6mm to 3" in simplex and multistrand versions. The chains are capable of handling powers from fractional to over 1000 kW, with operating speeds up to 25 metres per second. Cross+Morse Chains feature higher fatigue resistance and endurance limits achieved by using the latest methods in manufacture.

• **Pin and Bush Uniformity**

The High Endurance Limits of Morse Chain starts with the pins. Fine tolerance on pin diameters ensures optimum fit in outer link plate with accurate control of clearance between pin and bushing for correct lubrication, and pitch control. Bushes are 'curl-formed' from special quality cold rolled steel strip, into a cylindrical shape of uniform wall thickness.

• **Solid High Strength Rollers**

Morse Chain Rollers have solid walls for maximum strength, manufactured by machining from tube or cold extrusion process. The extruded rollers combine correct material grain orientation with high compressive residual surface stress for maximum impact resistance.

• **Precision Link Plates**

Link Plates are precision blanked from special through hardening steels with metallurgical composition selected to provide optimum tensile strength and fatigue resistance. Pin apertures are pierced and shaved to provide fine tolerance parallel bore holes, with accurate pitch control.

• **Heat Treatment**

Pins, bushes and rollers are case carburised and hardened under carefully controlled conditions to ensure correct balance between an extremely hard surface for wear resistance and a tough core for high impact strength. Link plates are subject to carbon restoration during hardening and tempering ensuring uniform optimum hardness and high tensile strength. Constant manual and electronic monitoring of Automatic Heat Treatment Plant ensures a uniform high quality product.

• **Chemical Blacking**

Roller Link Components are chemically blacked to improve corrosion resistance and adhesion of lubricants. Cross+Morse Chain can be instantly recognised by the resulting black and silver appearance

• **Easy De-Rivetting**

In order to enable the Customer to make their own chain lengths easy disassembly is built into Morse Chain through close tolerances on pins, link plates and rivet heads.

• **Assembly and Pre-Stress**

Heavy Press Fit of both pins and bushes into the side-plates creates a state of residual compressive stress around the apertures to further counteract service fatigue. The final manufacturing process is pre-stressing of the assembled chain. In this operation every pitch of chain is given one load cycle approaching the chains yield strength. Any parts in the assembly which, through manufacturing tolerance, are obliged to carry a greater share of the chain load, are caused to yield in their point of high stress. Pre-stressing the chain causes all components to equally share the work load so increasing resistance to fatigue.

• **Petrolatum Dipping**

All Morse Chains are dipped in anti-corrosive lubricant before packaging to afford the best available combination of pre-lubrication and rust protection. Applied hot, the petrolatum, with its superior corrosion-protecting qualities, penetrates every fine clearance of the chain assembly. Pre-lubrication with petrolatum gives the chain an excellent start in life, whether it receives periodic manual lubrication or is in an enclosed case with pump lubrication. The petrolatum will be dissolved through normal lubrication methods so it is not necessary to remove it from the chain on installation.

• **Quality Control**

Constant care and strict quality controls are exercised during raw material selection. Chemical analysis, metallurgical testing and product specifications are controlled through rigidly enforced quality control programmes throughout manufacturing and assembly. Assembled chain is subject to both mechanical and visual inspection to ensure it meets the required specifications. The high standards that are maintained are your assurance of a precision engineered product every time you specify Cross+Morse.

• **Appearance**

The quality of Morse Roller Chain is reflected in its fine appearance though careful attention to finishing by:- Deburring and polishing by barrelling all parts. The combination of polished outer link plates with chemically blacked roller units gives Cross+Morse Chains an attractive, distinctive appearance. Attractive strong package design providing protection against contamination and damage to finished chain during transportation and storage, ensure chain is in optimum condition when installed.

• **Precision Chain Sprockets**

To complete the Chain Drive a comprehensive range of Standard Pinions, Wheels and Platewheels stocked for B.S. Standard Chains up to 2" pitch are offered, and Sprockets for ANSI Chains and other special chains can be manufactured to customers specifications. Pinions and platewheels are normally manufactured from medium carbon steels for high strength, and can be induction hardened for additional wear resistance. Pinions and wheels for precision roller chain and inverted tooth chains have fully machined teeth to ensure accuracy of engagement with mating chains. Standard Sprocket Range includes taper bore sprockets and bushes for quick assembly, low price finished bore product with high torque capability; idler sprockets and chain tensioners.

• **Specialist Design**

An experienced staff of product specialists is available at the offices of Cross+Morse to assist Customers and Distributors in solving all their power transmission problems. Call your local representative and let him assume full responsibility for your Industrial Power Transmission requirements by specifying Cross+Morse.

By using modern chain manufacturing technology, combined with long established and proven specifications, Cross+Morse produce high performance Roller Chains of consistent quality.

Roller Chain Drive Design

Roller Chain by nature of its design is capable of transmitting high torque loads, and provides the ideal drive media for the connection of slow to medium speed shafts located on extended centres.

The selection and application is reasonably simple by following normal engineering practices, but there are points of good design practice specific to Roller Chain Drives, and consideration of these will ensure successful drive design.

• Numbers of Teeth in Sprockets

Chordal Action:- As a chain engages and disengages with a sprocket there is a rise and fall of each link, and a velocity variation. These are due to chordal action caused by the chain forming a polygon on the sprocket. In the diagrams below as Roller B approaches the sprocket it follows the chordal line of Roller A. Once engaged it is caused to rise following the arc of the pitch circle. As the chain unwraps from the sprocket the reverse occurs. As well as inducing a vibration into the chain, the linear velocity of the chain is varied from a minimum on effective radius d to a maximum on the pitch circle radius r . The level of this cyclic speed variation can be determined:-

$$\text{Chordal velocity variation} = 100 \left[1 - \cos \frac{180}{Z} \right] \%$$

where Z = number of teeth in sprocket.

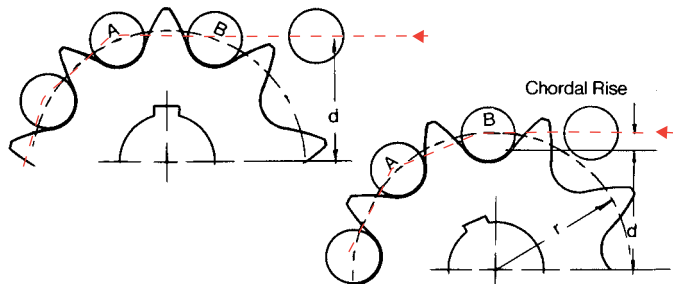

Chordal action is unavoidable, but its magnitude and effect can be minimised by using sprockets with high numbers of teeth, the value becoming insignificant on drives with 25 tooth sprockets or larger.

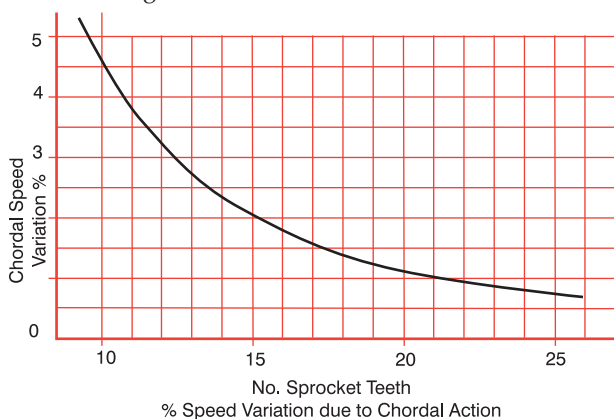

Odd Numbers of Teeth:- As most drives have a chain with an even number of pitches, using an odd number teeth in the sprockets will assist uniform wear distribution for both chain and sprocket. An exception to this is for 1:1 ratio drives where even tooth sprockets are preferred to minimise the effects of chordal action on the drive.

Number of Teeth in Large Sprocket:- It is recommended that chainwheels should have a maximum of 114 teeth. This limitation is due to mis-matching of worn chain with large sprockets which increases with the number of teeth in the sprocket. A simple formula to indicate percentage of chain wear a sprocket can accommodate is:-

$$\frac{200\%}{Z}$$

It is normally considered good practice to replace chain if wear elongation exceeds 2%.

It is considered good practice that the sum of teeth on drives and driven sprocket should not be less than 50.

• Drive Ratio

Roller Chain operates at high efficiency on drives with reduction ratios up to 3:1, but can be used effectively for drives up to 5:1 reduction. Higher ratios are not recommended but on some very slow speed drives reductions up to 10:1 have been used. High drive ratios require sprockets with large number of teeth, which restrict maximum chain wear with a resultant reduction in chain life. For reduction ratios above 5:1 consideration should be given to two-stage drive with idler shaft.

• Drive Arrangements

It is preferred to use Roller Chain on drives with horizontal shafting, although vertical shaft drives can be accommodated. Shaft centres may be displaced horizontal at an incline, or vertical, with each arrangement having its own specific requirement. Horizontally displaced shafts, and drives with centres inclination up to 60° , are the best and most common arrangements. On inclined drives the driver can be either above (as illustrated) or below the driven sprocket, but it is preferable to have the driving strand (tight side) of the chain uppermost.

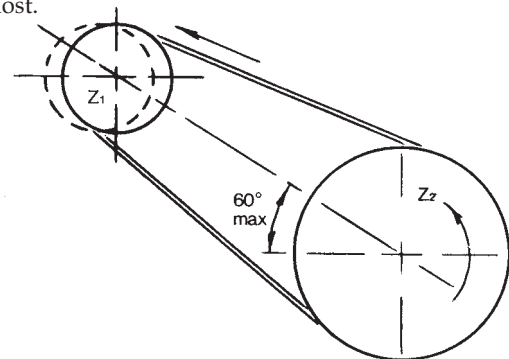

For vertically displaced shaft drives, including drives with an inclination of over 60° to the horizontal, additional maintenance is required to ensure chain is always correctly adjusted, and for this reason automatic means of chain adjustment is recommended for these arrangements. It is always preferred to have the driver sprocket above the driven sprocket, as chain wear creates reduced contact on the lower sprocket.

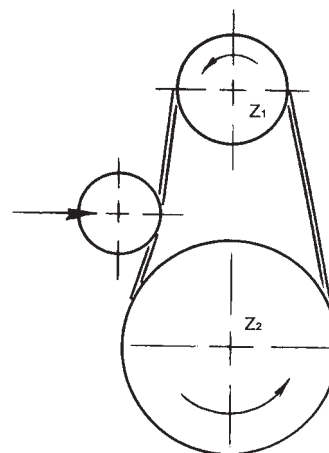

Roller Chain is not recommended for drives with vertical shafts, but providing the drive is well engineered, and certain basic rules followed, a satisfactory drive can be achieved. As the chain is supported by its side-plates on the sprockets, it is essential to use sprockets with high numbers of teeth (minimum 25 teeth) to spread the load. To minimise catenary side loads on the chain shaft centres should be kept to a minimum (30 pitches max), and multi-strand chains used where possible. For slow speed drives (up to 1 M/S) special chain guides are available to support simplex chain for longer centre drives. It is imperative that chains are maintained in correct tension at all times, if acceptable life is to be achieved, and to minimise the effects of wear, chain selection should be made with an additional design factor of 2.



Roller Chain Drive Design



Email sales@crossmorse.com
 Fax +44(0) 121 325 1079
 Fax +44(0) 121 360 0155
 Tel +44(0) 121 360 0155

• Shafts Centre Distance

For optimum chain life shaft centres within the range 30 to 50 times chain pitch should be used, refer to page 9. Drives with centres up to 80 times pitch will perform satisfactorily providing adequate adjustment of chain tension is available. For very long centres, consideration should be given using two stage drive with idler, or alternatively for lightly loaded, slow speed (up to 1 m/s) drives, supporting both strands of chain on chain guides.

Long Centre Drive using Supporting Guides

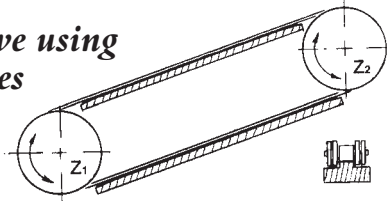

• Centre Distance Adjustment

When designing a chain drive ability to adjust the position of one shaft to compensate for chain wear, should be included, ideally equal to a minimum of 2 pitches of chain. If this is not possible, correction for chainwear can be achieved by the incorporation of adjustable idler or sprung loaded tensioner on the slack strand of the chain. Automatic adjustment for chain wear is recommended for drives with an inclination of more than 60° to the horizontal, see sketch. Idler or tensioner sprockets should be applied to the outside of the unloaded strand of the chain close to the driven sprocket, but allowing at least 5 pitches free length of chain between idler and sprocket at all times. Ideally at least 3 pitches of chain should engage with idler sprockets. Automatic tensioners cannot be used on reversing drives, or applications where high torque reversals could be encountered. Idlers also are not generally suitable for reversing drives.

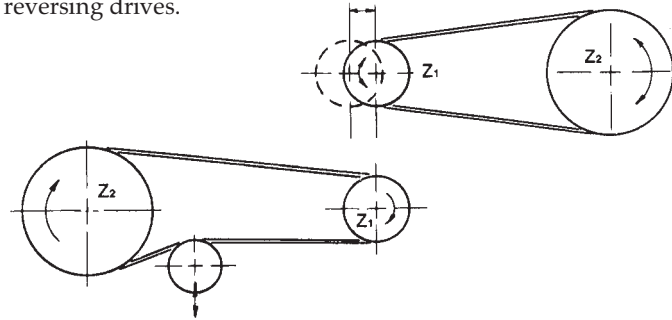

Multi-shaft Drives

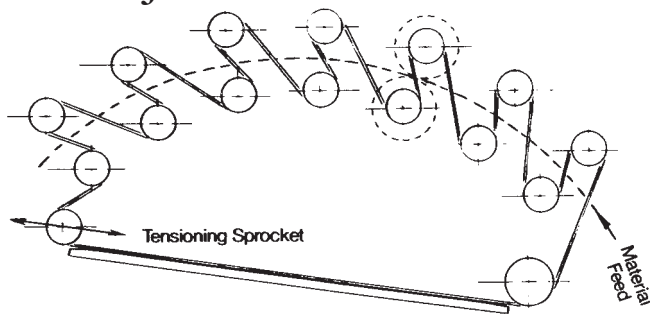

Typical Serpentine Drive

Drive to 7 pairs rollers in film process m/c

Roller Chain is often used to connect a number of shafts within one drive. Three arrangements are most common. Serpentine drives have the chain laced through a number of sprockets, so that some can be driven contra-rotation to the others.

These drives suffer high rates of wear due to the number of sprockets involved, and combined with necessary long chain length require inclusion of an idler with a lot of adjustment, within the drive. Sometimes a number of adjustable idlers are used.

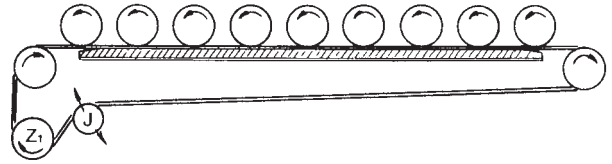

Light live roller conveyor drives can be powered using a single loop of chain with sprockets running on top. The chain should be supported on plastic chain guide to maintain constant contact with sprockets, alternatively where rollers are well spaced idler sprockets can be positioned opposite between each pair of sprockets, this increasing the angle of contact on the driven sprockets. The small contact between driven sprocket and chain requires that torque on any one roller should never exceed 15% of rated power for the drive. Chain speed should never exceed 1 m/s. An advantage of this layout is that the driven sprockets and shafts can be easily removed.

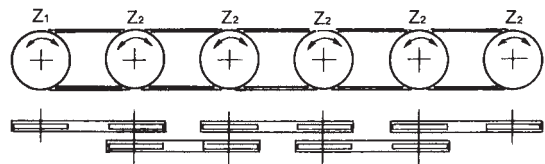

Powered live roller conveyors usually have the rollers connected by coupled simple drives, often with the use of double simple sprockets. To keep chain loads to a minimum it is preferable to connect input drive to centre roller, this keeping wear to a minimum. A simple chain drive operates with an efficiency of 98%, therefore an allowance of 2% should be made for power loss in each loop of chain in determining chain selection and drive motor requirements.

• Elevated Temperature and Stainless Steel Chains

Standard Roller Chain loses some of its performance capability at elevated temperatures, and also is more prone to corrosion problems. Hardness of pins and bushes become reduced affecting operating life. At temperatures over 170°C chain drive capacity is reduced, and this must be included in drive selection by applying the factor f_3 from the table below. Standard Chain should not be used in temperatures over 250°C. For elevated temperature applications it is preferable to select Stainless Steel Chains, with standard series suitable on applications to 325°C, and 300 series chain for temperatures to 500°C. Stainless Steel Chain has lower wear resistance at all temperature, and therefore factor f_3 in table below should be applied when making chain selection.

Factor f_3 (Stainless and Elevated Temperature)

Temperature	Standard Roller Chain	Stainless Roller Chain	300 Series Stainless
-5 to 170°C	1.0	2.0	2.6
170 to 200°C	1.35	2.3	2.75
200 to 250°C	2.0	2.6	2.9
250 to 325°C	-	2.75	3.2
325 to 425°C	-	-	4.0
425 to 500°C	-	-	5.0

Useful formulae: The following formulae can be used in the Design and Selection of Chain Belt Drives.

$$\text{Power (kW)} = \frac{\text{Torque Nm} \times \text{rev/min}}{9550}$$

$$\text{Belt/Chain Speed (M/sec)} = \frac{Z \times p \times \text{r.p.m.}}{60,000}$$

Z = No. Teeth in Sprocket or Pulley
p = Belt/Chain pitch mm

Further design formulae and conversion tables are provided in the catalogue appendix.

Roller Chain Drive Selection



Tel +44 (0) 121 360 0155 Fax +44 (0) 121 325 1079

Email sales@crossmorse.com

Selection Procedure for Chain Drives with Two Sprockets

This selection procedure and the chain ratings will provide for a life expectancy of 15,000 hours for drives which incorporate a method of adjustment for wear, are operating in a clean environment at normal ambient temperatures, and subject to proper maintenance and adequate lubrication at all times. In order to use the selection procedure it is first necessary to assemble all data relevant to the application, which should include:-

- Power to be transmitted.
- Input shaft speed, and output speed required or drive ratio.
- Type of driver and driven equipment.
- Centres and layout of shafts.
- Shaft diameters.
- Environmental conditions.

Selection Procedure

The correct size of chain for an application can be made by reference to Selection Charts relating shaft speed and design power. The design power P_d is determined from the motor power P and application factors, f_1 , f_2 and f_3 if applicable.

$$P_d = P f_1 f_2 (f_3)$$

Where f_1 = Service Factor
 f_2 = Sprocket Size Factor
 f_3 = Temperature Factor
 also stainless steel chains refer to Page 6.

1. Service Factor - f_1

The service factor f_1 can be determined from details of the driver and driven equipment by selection from the table below. The service factor is applied to take into consideration the source of power, nature of the load, load inertia strain or shock, and the average hours per day of service. Normal duty drives are those with relatively little shock or load variation. Examples of typical drivers and driven equipment, are given at the bottom of the page.

2. Sprocket Sizes - f_2

The sprocket sizes are determined by the drive ratio required.

$$\text{Drive Ratio } i = \frac{\text{R.P.M. High Speed Shaft } n_1}{\text{R.P.M. Low Speed Shaft } n_2}$$

$$= \frac{\text{No. Teeth Large Sprocket } Z_2}{\text{No. Teeth Small Sprocket } Z_1}$$

Suitable sprockets can be selected from Ratio Table Page 8 with consideration given to the following.

Unless shaft speeds are very low it is advisable to use a minimum of 17 tooth sprockets. If the drive operates at high speeds or is subject to impulse load sprockets should have at least 25 teeth and should be hardened.

For low ratio drives, sprockets with high numbers of teeth minimise joint articulation, and bearing loads, thus extending chain life. On drives where ratios exceed 5:1 the designer should consider using compound drives for maximum service life. Having selected the number of teeth of the sprockets factor f_2 can be determined from the table below.

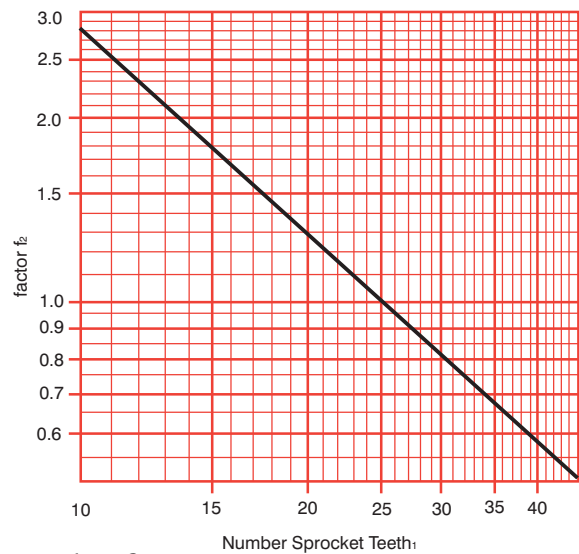

Application factor f_1 - Service Factor

Characteristics of Driven Machine	Characteristics of Driver		
	Smooth Running	Slight Shock	Moderate Shock
Smooth Running	1.0	1.1	1.3
Moderate Shock	1.4	1.5	1.7
Heavy Shock	1.8	1.9	2.1

Example of Drivers

Smooth Running	Electric Motors Steam and Gas Turbines Internal Combustion Engines with Hydraulic Coupling
Slight Shock	Internal Combustion Engines with 6 Cylinders or more with Mechanical Coupling
Moderate Shock	Internal Combustion Engines with less than 6 Cylinders with Mechanical Coupling

Examples of Driven Machines

The following list classifies common driven mechanisms into their various duty ratings, given as a guide to assist in the final determination of the actual operating characteristics

Bakery Machinery	Moderate Shock
Brick and Clay Machinery	Heavy Shock
Centrifuges	Heavy Shock
Compressors:	
Centrifugal and Rotary	Smooth
Reciprocating	Heavy Shock
Conveyors:	
Apron, Bucket, Elevator, Pan	Heavy Shock
Belt (Uniformly Loaded)	Smooth
Flight, Screw	Heavy Shock
Cotton Oil Plants	Heavy Shock
Cranes	Moderate to Heavy Shock
Crushing Machinery	Heavy Shock
Fans and Blowers:	
Centrifugal or Induced Draft	Moderate Shock
Mine Fans, Positive Blowers	Heavy Shock
Propellers	Heavy Shock

Flour, Feed or Cereal Mill Machinery:	
Separators, Sifters, Purifiers	Smooth
Roller Mills, Grinders	Moderate Shock
Generators and Exciters	Moderate Shock
Laundry Machinery	Moderate Shock
Liquid Agitators, Paddles or Propeller	Smooth
Mills	Heavy Shock
Paper Machinery:	
Agitators, Calendars, Dryers, Jordan Engines	Moderate Shock
Beaters, Chippers, Nash Pumps,	
Washers, Winder Drums, Yankee Dryers	Heavy Shock
Printing Machinery	Smooth
Pumps:	
Centrifugal, Gear, Rotary	Moderate Shock
Dredge, Duplex, Triplex,	Heavy Shock
Rubber Plant Machinery	Heavy Shock
Textile Machinery	Smooth

Roller Chain Drive Selection



3. Chain Size Selection

Having determined values for factors f_1 , f_2 and f_3 (if applicable), the design Power can be determined.

$$P_d = P \cdot f_1 \cdot f_2 \cdot f_3$$

By relating the design Power P_d with the rotational speed of the small sprocket n_1 on the Capacity Chart pp10/11 the correct size of chain for the application can be selected. Use the Capacity Charts to select the smallest pitch of simplex chain which will transmit the design Power, as this normally provides the most economic selection. However, other factors should also be considered when making this selection.

a. The preferred centre distance ranges between 30 and 50 times the chain pitch, and there should always be a minimum arc of contact of the chain on the small sprocket of 120° ; or for sprockets with low numbers of teeth a minimum of 5 teeth in contact. The following are preferred centre distances against chain pitch.

Chain Pitch	8mm	3/4"	1/2"	5/8"	3/4"	1"
Min. Centres	240	280	380	470	570	760
Max. Centres	400	480	640	800	960	1270

Chain Pitch	1 1/4"	1 1/2"	1 3/4"	2"	2 1/2"	3"
Min. Centres	950	1140	1320	1500	1900	2275
Max. Centres	1590	1920	2250	2550	3200	3850

There will always be a minimum arc of contact of 120° if the centre distance in pitches is greater than $0.32x$ the difference in numbers of teeth of driven and driver sprocket.

b. When a compact drive is required, then a multiplex chain of a smaller pitch should be used with resultant reduction in chain wheel diameters.

Ratios possible with Stock Sizes

		Number of Teeth - Driver Sprocket																					
		9	10	11	12	13	14	15	16	17	18	19	20	21	22	23	24	25	26	27	30		
Number of Teeth - Driven Sprocket	11	1.22	1.10	1.00																			
	12	1.33	1.20	1.09	1.00																		
	13	1.44	1.30	1.18	1.08	1.00																	
	14	1.56	1.40	1.27	1.17	1.08	1.00																
	15	1.67	1.50	1.36	1.25	1.15	1.07	1.00															
	16	1.78	1.60	1.45	1.33	1.23	1.14	1.07	1.00														
	17	1.89	1.70	1.55	1.42	1.31	1.21	1.13	1.06	1.00													
	18	2.00	1.80	1.64	1.50	1.38	1.29	1.20	1.13	1.06	1.00												
	19	2.11	1.90	1.73	1.58	1.46	1.36	1.27	1.19	1.12	1.06	1.00											
	20	2.22	2.00	1.82	1.67	1.54	1.43	1.33	1.25	1.18	1.11	1.05	1.00										
	21	2.33	2.10	1.91	1.75	1.61	1.50	1.40	1.31	1.23	1.17	1.10	1.05	1.00									
	22	2.44	2.20	2.00	1.83	1.69	1.57	1.47	1.38	1.29	1.22	1.16	1.10	1.05	1.00								
	23	2.56	2.30	2.09	1.92	1.77	1.64	1.53	1.44	1.35	1.28	1.21	1.15	1.10	1.05	1.00							
	24	2.67	2.40	2.18	2.00	1.85	1.71	1.60	1.50	1.41	1.33	1.26	1.20	1.14	1.09	1.04	1.00						
	25	2.78	2.50	2.27	2.08	1.92	1.79	1.67	1.56	1.47	1.39	1.32	1.25	1.19	1.14	1.09	1.04	1.00					
	26	2.89	2.60	2.36	2.17	2.00	1.86	1.73	1.63	1.53	1.44	1.37	1.30	1.24	1.18	1.13	1.08	1.04	1.00				
	27	3.00	2.70	2.45	2.25	2.08	1.93	1.80	1.69	1.59	1.50	1.42	1.35	1.29	1.23	1.17	1.12	1.08	1.04	1.00			
	28	3.11	2.80	2.54	2.33	2.15	2.00	1.87	1.75	1.65	1.56	1.48	1.40	1.33	1.27	1.22	1.16	1.12	1.08	1.04			
	29	3.22	2.90	2.64	2.42	2.23	2.07	1.93	1.81	1.71	1.61	1.53	1.45	1.38	1.32	1.26	1.21	1.16	1.12	1.07			
30	3.33	3.00	2.73	2.50	2.31	2.14	2.00	1.88	1.76	1.67	1.58	1.50	1.43	1.36	1.30	1.25	1.20	1.15	1.11	1.00			
32	3.56	3.20	2.91	2.67	2.46	2.28	2.13	2.00	1.88	1.78	1.68	1.60	1.52	1.45	1.39	1.33	1.28	1.23	1.19	1.07			
35	3.89	3.50	3.18	2.92	2.69	2.50	2.33	2.19	2.06	1.94	1.84	1.75	1.67	1.59	1.52	1.46	1.40	1.34	1.30	1.17			
38	4.22	3.80	3.45	3.17	2.92	2.71	2.53	2.38	2.24	2.11	2.00	1.90	1.81	1.73	1.65	1.58	1.52	1.46	1.41	1.27			
40	4.44	4.00	3.64	3.33	3.08	2.86	2.67	2.50	2.35	2.22	2.10	2.00	1.90	1.82	1.74	1.67	1.60	1.54	1.48	1.33			
45	5.00	4.50	4.09	3.75	3.46	3.21	3.00	2.81	2.65	2.50	2.37	2.25	2.14	2.04	1.96	1.88	1.80	1.73	1.67	1.50			
57	6.33	5.70	5.18	4.75	4.38	4.07	3.80	3.56	3.35	3.17	3.00	2.85	2.71	2.59	2.48	2.37	2.28	2.19	2.11	1.90			
76	8.44	7.60	6.91	6.33	5.85	5.43	5.07	4.75	4.47	4.22	4.00	3.80	3.62	3.45	3.30	3.17	3.04	2.92	2.81	2.53			
95		9.50	8.64	7.92	7.31	6.79	6.33	5.94	5.59	5.28	5.00	4.75	4.52	4.32	4.13	3.96	3.80	3.65	3.52	3.17			
114				9.50	8.77	8.14	7.60	7.12	6.71	6.33	6.00	5.70	5.43	5.18	4.96	4.75	4.56	4.38	4.22	3.80			

The Capacity Charts are based on drives of uniform operation without over loads, shocks or frequent starts, using a 25 tooth pinion, and can be used to select drives with corrected design Power where:-

- The chain drive consists of two chain wheels mounted on parallel, horizontal shafts.
- The drive has a maximum speed reduction of 3:1.
- The operating temperature is within the range -5°C to 70°C .
- The chainwheels are correctly aligned and the chain maintained in correct adjustment at all times. Refer to page 13.
- An adequate supply of clean lubricant is maintained.
- The chain is of rivetted construction without any crank links.
- The chain has a length of 120 pitches. A shorter chain length will still be suitable to transmit the powers indicated, but the wear life will be proportionally reduced. Chains of longer length give little improvement in overall life, and chains over 150 pitches should only be used when shaft speeds are low.

4. Check Drive Selection

Check with sprocket dimensions pp 32/58 to ensure sprocket will accommodate shaft sizes. If shaft diameters exceed maximum bore of selected sprockets it will be necessary to increase numbers of teeth in sprockets or select larger pitch chain.

Check that sprocket diameters and chain clearance requirements can be accommodated within the space envelope. If dimensions are restricted select multi-strand chains of smaller pitch.

5. Determine Chain Length and Actual Centre Distance

Refer to page 9 for calculations of chain length. Note that for all drives the shaft centres should be at least 2mm greater than half the sum of the sprocket outside diameters; and for drives with ratio greater than 3:1 centres should be minimum of the summation of the sprocket pitch circle diameters

Chain Length and Centre Distance Calculations



For chain drives incorporating two sprockets, and given an approximate shaft centre distance, the following procedures can be used to determine chain length and actual centre distance.

A. Determining number of pitches in chain.

1. For drives where sprockets have same number of teeth.

$$\text{Chain Length Pitches } L_C = \frac{2 A_o + z}{p}$$

2. For drives where sprockets have different number of teeth.

- Divide the centre distance A_o mm by pitch chain p mm to obtain C
- Add teeth in the small sprocket Z_1 to the teeth in the larger sprocket Z_2 to obtain S
- Subtract the teeth in the small sprocket Z_1 from the teeth in the large sprocket Z_2 to obtain value D
From the table below obtain corresponding value K
- Chain lengths in pitches $L_C = 2C + \frac{S}{2} + \frac{K}{C}$

3. The calculated chain length L_C will need to be rounded to the nearest whole number of pitches, with preference to even numbers to avoid the use of crank link connectors. Where tensioners are to be used in the drive the calculated chain length should also be increased to obtain actual length L_A . To convert to length in feet or metres, use conversion table below.

4. To obtain actual centre distance, A , having decided on the actual chain length, L_A pitches, the following formula can be used.

$$A = p \left[\frac{L_A - S/2 + \sqrt{[L_A - S/2]^2 - 8K}}{4} \right]$$

This provides a reasonably accurate result, but for fixed centre drives some correction will be required, and for these you are advised to use conversion tables or consult Cross+Morse Technical Department.

Where:-

- A = Actual Centre Distance (mm)
- A_o = Approx. Shaft Centres (mm)
- L_C = Calculated Chain Length Pitches
- L_A = Actual Number of Pitches
- p = Chain Pitch (mm)
- Z_1 = Number of Teeth in Small Sprocket
- Z_2 = Number of Teeth in Large Sprocket

Example:

Given: $Z_1 = 25$, $Z_2 = 60$, $p = \frac{1}{2}$ inch = 12.7mm.
Approx. Centre Distance $A_o = 610$ mm.

Determine:

- Chain length L_C to nearest even number of pitches.
- Centre distance based on actual number of pitches L_A .

Solution:

- $C = 610 \div 12.7 = 48.03$
- $S = 25 + 60 = 85$
- $D = 60 - 25 = 35$, corresponding $K = 31.03$
- $L_C = \frac{(2 \times 48.03) + 85 + 31.03}{2 \times 48.03} = 139.21$ pitches
- $L_A = 140$ pitches (nearest even number).
- Actual Centre Distance A

$$= 12.7 \left[\frac{140 - 85/2 + \sqrt{[140 - 85/2]^2 - 8 \times 31.03}}{4} \right]$$

$$= 615.056\text{mm.}$$

$\frac{1}{2}$ inch Pitch Chain operating in 60 and 25 Tooth Sprockets will require 140 pitches of chain for a nominal Centre Distance of 615.05mm.

D	K	D	K	D	K	D	K	D	K	D	K
1	.03	26	17.12	51	65.88	76	146.31	101	258.39	126	402.14
2	.10	27	18.47	52	68.49	77	150.18	102	263.54	127	408.55
3	.23	28	19.86	53	71.15	78	154.11	103	268.73	128	415.01
4	.41	29	21.30	54	73.86	79	158.09	104	273.97	129	421.52
5	.63	30	22.80	55	76.62	80	162.11	105	279.27	130	428.08
6	.91	31	24.34	56	79.44	81	166.19	106	284.67	131	434.69
7	1.24	32	25.94	57	82.30	82	170.32	107	290.01	132	441.36
8	1.62	33	27.58	58	85.21	83	174.50	108	295.45	133	448.07
9	2.05	34	29.28	59	88.17	84	178.73	109	300.95	134	454.83
10	2.53	35	31.03	60	91.19	85	183.01	110	306.50	135	461.64
11	3.06	36	32.83	61	94.25	86	187.34	111	312.09	136	468.51
12	3.65	37	34.68	62	97.37	87	191.72	112	317.74	137	475.42
13	4.28	38	36.58	63	100.54	88	196.16	113	323.44	138	482.39
14	4.96	39	38.53	64	103.75	89	200.64	114	329.19	139	489.41
15	5.70	40	40.53	65	107.02	90	205.17	115	334.99	140	496.47
16	6.48	41	42.58	66	110.34	91	209.76	116	340.84	141	503.59
17	7.32	42	44.68	67	113.71	92	214.40	117	346.75	142	510.76
18	8.21	43	46.84	68	117.13	93	219.08	118	352.70	143	517.98
19	9.14	44	49.04	69	120.60	94	223.82	119	358.70	144	525.25
20	10.13	45	51.29	70	124.12	95	228.61	120	364.76	145	532.57
21	11.17	46	53.60	71	127.69	96	233.44	121	370.86	146	539.94
22	12.26	47	55.95	72	131.31	97	238.33	122	377.02	147	547.36
23	13.40	48	58.36	73	134.99	98	243.27	123	383.22	148	554.83
24	14.59	49	60.82	74	138.71	99	248.26	124	389.48	149	562.36
25	15.83	50	63.33	75	142.48	100	253.30	125	395.79	150	569.93

Chain Length Conversion Data

Chain Pitch (ins)	Pitches/ft	Pitches/Metre	Chain Pitch (ins)	Pitches/ft	Pitches/Metre	Chain Pitch (ins)	Pitches/ft	Pitches/Metre	Chain Pitch (ins)	Pitches/ft	Pitches/Metre
$\frac{1}{4}$ "	48	157.480	$\frac{5}{8}$ "	19.2	62.992	$\frac{1}{4}$ "	9.6	31.496	2"	6.0	19.685
$\frac{3}{8}$ "	32	104.987	$\frac{3}{4}$ "	16	52.493	$\frac{1}{2}$ "	8	26.247	$2\frac{1}{2}$ "	4.8	15.748
$\frac{1}{2}$ "	24	78.740	1"	12	39.370	$\frac{3}{4}$ "	6.857	22.497	8mm	38.1	125.000

Chain Drive Selection Power Rating Graph - British Standard Chains



Tel +44(0) 121 360 0155 Fax +44(0) 121 325 1079 Email sales@crossmorse.com

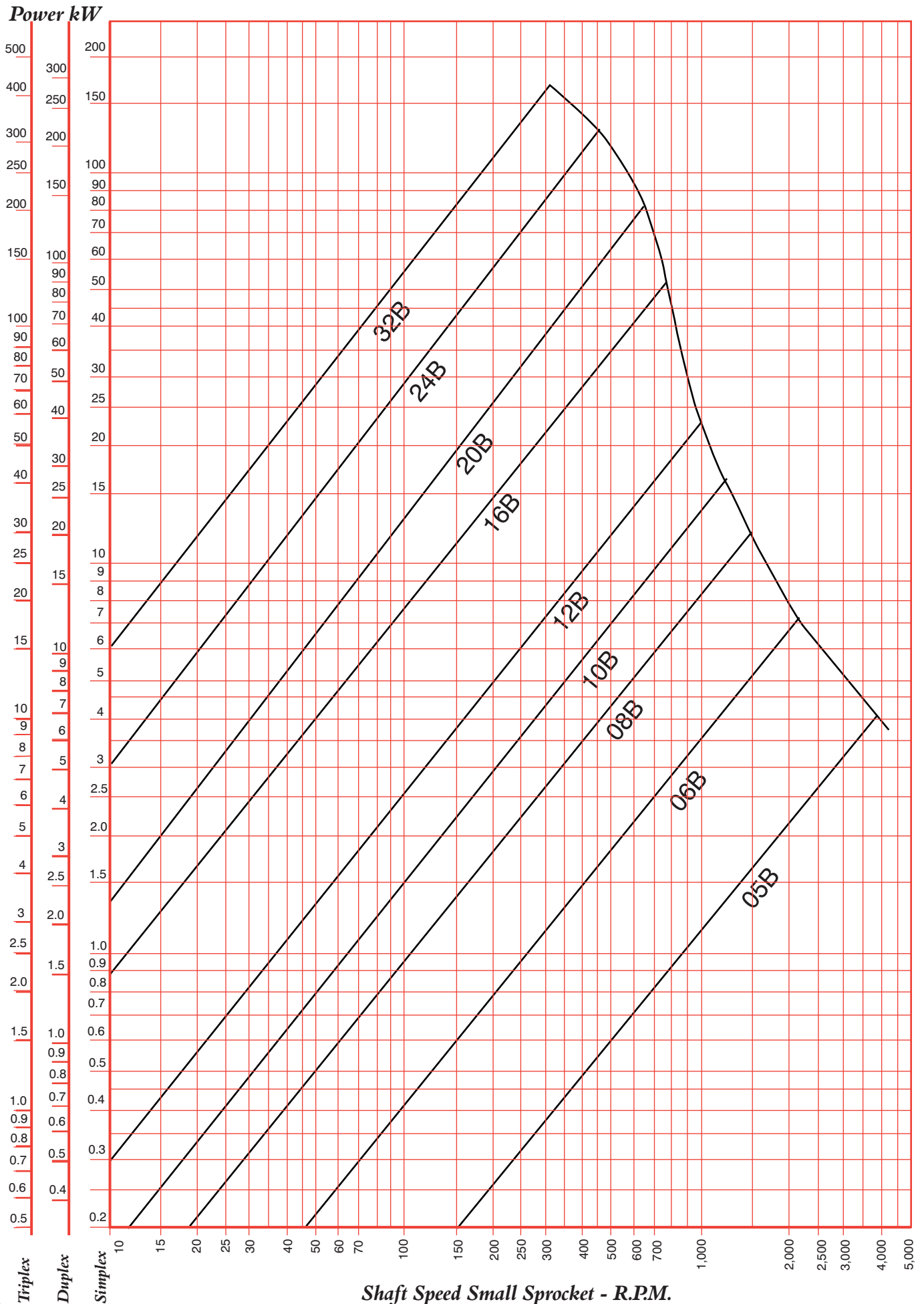

Chain Drive Selection Power Rating Graph - American Standard Chains



Tel +44(0) 121 360 0155

Fax +44(0) 121 325 1079

Email sales@crossmorse.com

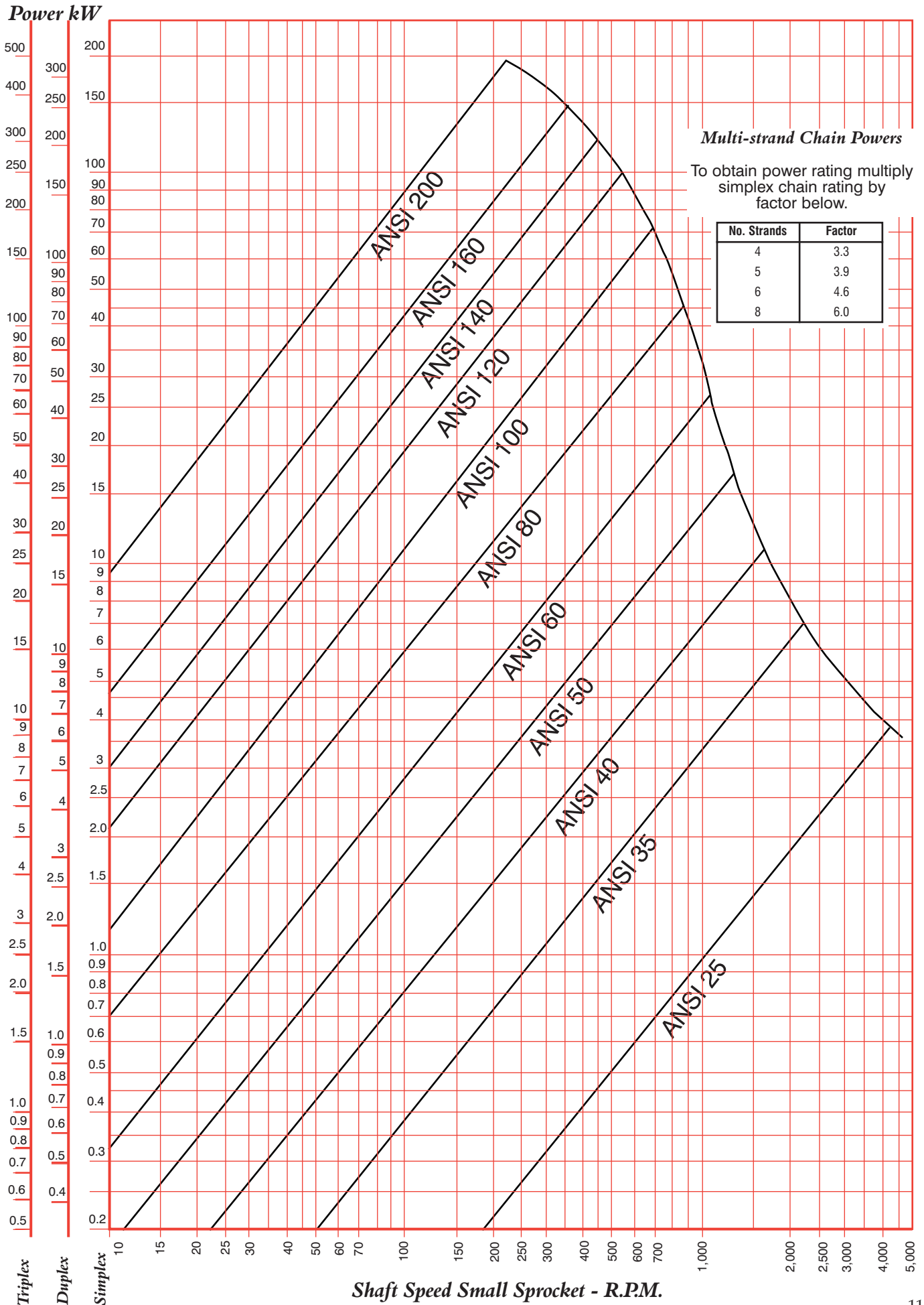

Chain Lubrication



Email sales@crossmorse.com
 Fax +44(0) 121 325 1079
 Fax +44(0) 121 360 0155
 Tel +44(0) 121 360 0155

Lubrication Systems

An adequate supply of lubrication is necessary to ensure a satisfactory wear life for any chain drive. Roller chain when supplied is coated in a heavy petroleum grease to provide protection until installation. For some slow, light load applications this lubrication is adequate providing a short wear life can be accepted, but for the majority of applications an oil lubrication system to provide further lubrication will be required, the type being dependant on chain size, loads and operating speed. When oil is applied to a roller chain a separating wedge of fluid is formed in the operating joints, similar to journal bearings, thereby minimising metal to metal contact. When applied in sufficient volume the oil also provides effective cooling and impact dampening at higher speeds. Chain life will vary appreciably depending on the lubrication system used, and therefore it is important that lubrication recommendations are complied with. The chain rating tables used for selection only apply for drives lubricated in line with the following recommendations. Chain drives should be encased for protection from dirt and moisture, and oil supplies should be kept free of contamination. A good quality, petroleum-based, non detergent thin oil should be used, and changed periodically (Max. 3000 hours operating life). Heavy oils and greases are not recommended for most applications, because they are too stiff to enter the small spaces between precision chain components. The following table indicates correct lubricant viscosity for various ambient temperatures.

Temperature °C	Oil Viscosity	Commercial Grade
-5 to +5	VG 68	SAE 20
5 to 25	VG 100	SAE 30
25 to 45	VG 150	SAE 40
45 to 70	VG 220	SAE 50

There are four basic types of lubrication for chain drives, the correct one being determined by chain size and speed. This provides for the minimum lubrication requirements, but the use of a higher type (i.e. type 3 instead of type 2) will normally be beneficial to chain life and performance. The correct type can be selected from graph below of chain speed against chain size. Refer to page 6 for chain speed calculation.

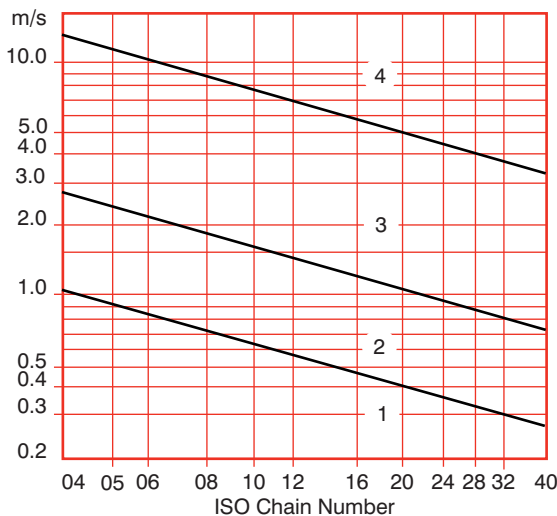

Type 1 - Manual Lubrication

Oil is applied with a brush or oil-can at least once every 8 hours of operation. The volume and frequency of application should be sufficient to keep the chain wet with oil and prevent overheating or discolouration of lubricant in the chain joints. The use of aerosol-can lubricant is often satisfactory on slow speed drives. It is important that the lubricant used is of a type specified for roller chains, most of which include P.T.F.E. or other additive to reduce friction.

Caution - Manual types of lubrication must never be applied while drive is in operation.

Type 2 - Drip Feed Lubrication

Oil drops are directed between the link plate edges from a drip lubricator. Volume and frequency should be sufficient to prevent discolouration of lubricant in the chain joints. Precaution must be taken against misdirection of the drops by wind from the passing chain.

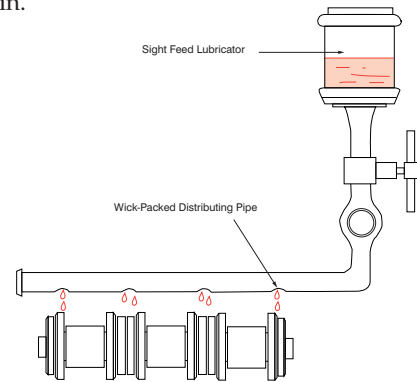

Type A - Drip Feed Lubrication

Type 3 - Oil Bath or Disc Lubrication

With oil bath lubrication the lower strand of the chain passes through a bath of oil in an enclosed chain case. The oil level must be carefully controlled to be between the pitch line and top of the chain at its lowest point. Adequate sump capacity is required to avoid overheating the oil, as a guide capacity in litres should at least equal half weight of chain Kg/m. This form of lubrication is most effective when the lower strand of chain is the slack strand.

With disc lubrication the chain operates above the oil level. A disc picks up oil and slings it against a collector plate from which it collects in a trough to drip onto the chain. The disc must be sized to produce rim speeds between 4 and 40 m/s. Generally disc slinger systems are only capable of delivering small quantities of oil and thus should be restricted to lower power drives (up to 25 kW).

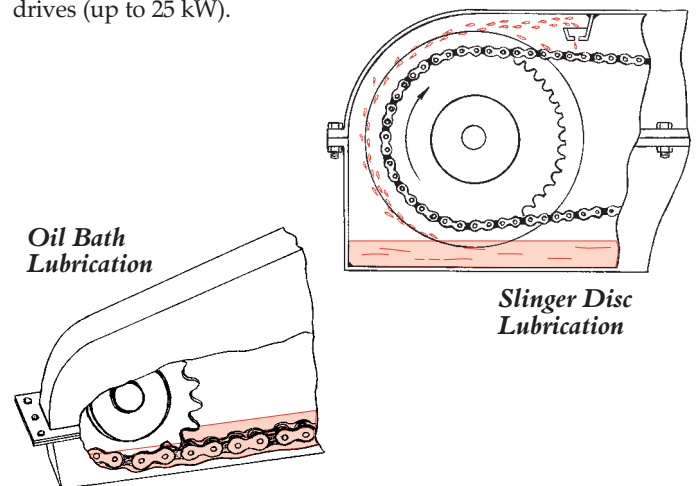

Type 4 - Forced Feed Lubrication

Oil is pressure fed from a circulating pump, or central lubrication system, via a spray bar, onto the chain. The spray bar should have holes 3mm dia. positioned over the side plates of the chain (see sketch for drip feed), so as to direct the oil between the side plates. The spray bar should be located inside the chain loop close to the driven sprocket and approximately 5cm from the slack strand of the chain, with oil holes directed to deliver oil onto the chain as it enters the driven sprocket.

Oil flow rate should be a minimum of 3.5 litres/min per strand width of chain. Oil reservoir capacities should be a minimum of 3 times oil flow rate, and lubrication system should include a full flow oil filter.

For lubrication requirements outside the above recommendations consult Cross+Morse Engineering Department.

Chain Drive Installation and Maintenance



Tel +44(0) 121 360 0155

Fax +44(0) 121 325 1079

Email sales@crossmorse.com

Alignment of Shafts and Sprockets

Although Roller Chain provides a flexible connection of shafts, careful and accurate installation is necessary for trouble free operation.

The shafts must be rigidly supported by suitable bearing assemblies, and must be accurately aligned. The use of a spirit level is recommended to ensure shafts are horizontally aligned. Measurement between shafts at their extremities will determine parallelism. On fixed centre designs, manufacturing tolerance should ensure total shaft misalignment can never exceed 0.1%. Sprockets should have tight fit on shafts, with close fit keys and set screws to ensure rigid mounting, and should be located close to the support bearing. Sprocket alignment can be checked by a straight edge on the tooth faces, or for longer centre drives a taut wire. Ideally sprockets should be in-line, but if not, misalignment must never exceed 4% pitch of chain or severe damage will be caused to the drive.

Accurate alignment of shafts and sprockets ensures uniform load distribution across chain width. Alignment should be checked periodically for maximum chain life. When replacement chain is installed check sprockets for abnormal wear which indicates misalignment.

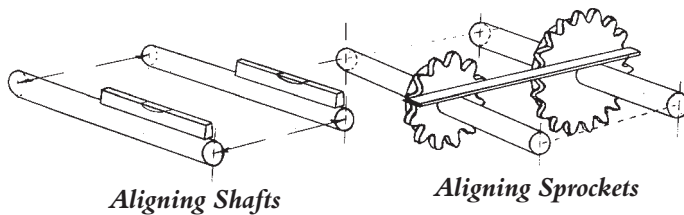

Chain Installation

If centre distance adjustment is available centres should be reduced to a minimum to assist with chain installation. Wrap chain around the two sprockets and bring the ends together around the larger sprocket in mesh with the teeth which will hold the links in correct position. The connecting link can then be inserted, care being taken to ensure that for duplex and triplex chains the centre link plates are fitted. Where spring clip connecting links are used the closed end of the spring clip must face the direction of rotation. For high speed drives or drives working in arduous conditions it is preferable to use a rivetting connecting link. This can be installed in the same manner, but the back of the link must be rigidly supported whilst the interference fit outer link is fitted and the pins rivetted over.

Chain Tension

To obtain the full life of a chain drive some means of chain length adjustment is necessary. The preferred method is by moving one of the shafts, but if this is not possible an adjustable or sprung loaded idler sprocket engaging with the outside of the slack strand of chain is recommended. Where manual adjustment is required this should be carried out regularly. The total slack in the chain can be determined by counter rotating the sprockets so one strand is taut, and then measuring the total sag between chain and a straight edge midway between the sprockets. For horizontal drives this sag should be 1 - 2% of the centre distance, for vertical drives it should be only 0.5 to 1%

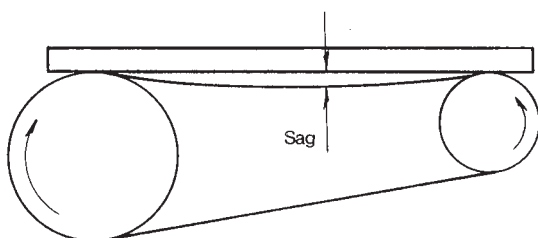

Matched Chains

Combination of powers and speeds sometimes require the use of paired transmission chains operating on double multi-strand sprockets. For these transmission applications chains are built up from shorter sections which are accurately measured and graded for length. Chains from one grade are then used to form a matched pair of chains complete or in handling sections. Chains are suitably identified to ensure correct installation on site. Many light conveying applications use a pair of transmission chains with attachments. As these chains are often connected by the equipment the attachments carry, matching of the chains is required. There are two levels of matching available:
Simple pairing:- Determines that the length of two strands of chain are the same, this being suitable for short run conveyors.
Selective Pairing:- Involves the accurate measurement of handling lengths, usually 3m long which are then paired and identified for assembly into the total matched pair of chains.

Maintenance of Chain Drives

For slow speed drives employing manual lubrication of the chain, frequent access to the drive is made for relubrication. Whilst lubricating the chain visual inspection of both chain and sprockets for abnormal wear and damage should be made, also apparent levels of sag observed.

For higher speed drives employing automated methods of lubrication regular checks of oil levels will be required to ensure they never fall below minimum levels. The frequency of these checks will vary with operating conditions for each drive, and can only be determined by experience. With oil bath lubrication, it is important to check more frequently as bath lubrication is effective only within a narrow band of oil level.

It is good preventative maintenance to make routine external inspection of the machinery to ensure it is running smoothly, and recommended that detailed inspection to be made at least 3 times a year. After the first 500 hours of operation oil should be changed and a complete inspection made and centres adjusted if applicable. Oil should then be changed at least once a year or earlier if it is discoloured or contaminated. At oil changes, make a complete examination of chain, sprockets, shafts, bearings, seal and lubrication system, also check alignment and sag, and correct as necessary.

For efficient, reliable operation of chain drives it is recommended to replace the chains when elongation due to wear exceeds 2%. If maintenance records of centre distance adjustment are kept it can be determined when the chain will require replacing, as centres will also have increased by more than 2%. Otherwise it will be necessary to remove the chain from the drive and measure it over a whole number of pitches approx. 600mm length for chains below 1 inch pitch or, 1200mm for longer pitch chains, at a load of 1% of the catalogue tensile strength. Replace chain if length greater than:- $1.02Xp$ where X = number pitches measured. If a chain has not worn in excess of 2%, but there is insufficient adjustment available on the drive to correctly tension the chain, it can be shortened in length by the removal of a number of pitches. It is not good practice to introduce new components into a well worn chain, as this will cause uneven running with subsequent damage, and for this reason it is always preferred to reduce the chain length by an even number of pitches, unless an offset link was fitted from original installation. To reduce a normal chain assembly, incorporating a connecting link, by two pitches remove the first outer link away from the connecting link using the chain breakers illustrated on page 37.

Caution

Chain drives can be dangerous if not handled correctly. Whilst drives are in operation chain cases and guards should be secured in place to prevent any contact. Prior to removal of guards ensure that power source has been switched off and isolated.

When removing, replacing, or altering a chain always:-

1. Wear protective clothing appropriate including safety glasses, gloves and shoes.
2. Use correct tools, and ensure they are in good working order.
3. Support the chain and sprockets to avoid sudden movement.
4. Release all tensioning devices.
5. Ensure chain construction is fully understood.

When chain is removed and inspected never re-use any damaged chain or component.

British Standard Precision Roller Chain

Conforming to ISO 606 and DIN 8187



Simplex Roller Chains

Email sales@crossmorse.com

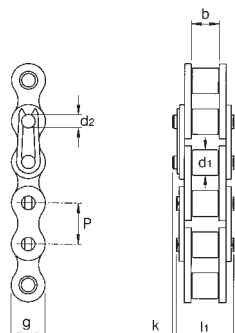

Cat No.†	Pitch P	Inside Width b min mm	Roller Dia. d1 max. mm	Pin Dia. d2 max. mm	Plate Depth g mm	Pin Length l1 max. mm	Con Pin Ext. k mm	Transverse Pitch e mm	Bearing Area cm ²	Tensile Strength N	Approx Weight kg/m
04 B†	6mm	2.80	4.00	1.85	5.0	7.4	2.9		0.07	3,000	0.12
05 B-1	8mm	3.00	5.00	2.31	7.1	8.6	3.1		0.11	4,600	0.18
06 B-1	3/8 inch	5.72	6.35	3.28	8.3	12.8	2.2		0.28	9,100	0.41
08 B-1	1/2 inch	7.75	8.51	4.45	11.8	16.2	2.1		0.50	18,200	0.70
081-1	1/2 inch	3.30	7.75	3.66	9.9	10.2	1.5		0.21	8,200	0.28
083-1	1/2 inch	4.88	7.75	4.09	10.3	12.9	1.5		0.32	12,000	0.42
084-1	1/2 inch	4.88	7.75	4.09	11.1	14.8	1.5		0.35	16,000	0.59
08L †	1/2 inch	6.40	7.75	3.97	11.5	15.1	2.0		0.38	16,000	0.53
08N †	1/2 inch	4.88	7.75	3.66	9.9	10.9	2.8		0.28	8,200	0.33
086 †	1/2 inch	5.21	8.51	4.45	11.6	15.0	3.9		0.39	18,200	0.62
101 †	5/8 inch	6.48	10.16	5.08	15.0	16.0	3.5		0.51	22,700	0.80
10 B-1	5/8 inch	9.65	10.16	5.08	14.7	18.6	2.2		0.67	22,700	0.96
12 B-1	3/4 inch	11.68	12.07	5.72	16.1	21.9	2.6		0.89	29,000	1.23
16 B-1	1 inch	17.02	15.88	8.28	21.1	35.6	3.1		2.10	64,000	2.60
20 B-1	1 1/4 inch	19.56	19.05	10.19	26.3	41.0	3.1		2.95	98,000	3.70
24 B-1	1 1/2 inch	25.40	25.40	14.63	33.3	53.4	3.5		5.54	170,000	6.90
28 B-1	1 3/4 inch	30.99	27.94	15.90	37.0	65.8	3.6		7.40	200,000	8.60
32 B-1	2 inch	30.99	29.21	17.78	40.6	64.8	3.8		8.11	260,000	9.50

† Cat No. equates to ISO 606 Chain ref. except where indicated, which are chains to factory std.

Duplex Roller Chains

Fax +44(0) 121 325 1079

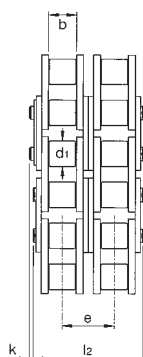

Cat No.†	Pitch P	Inside Width b min mm	Roller Dia. d1 max. mm	Pin Dia. d2 max. mm	Plate Depth g mm	Pin Length l2 max. mm	Con Pin Ext. k mm	Transverse Pitch e mm	Bearing Area cm ²	Tensile Strength N	Approx Weight kg/m
05 B-2	8mm	3.0	5.0	2.31	7.1	14.3	3.1	5.64	0.22	8,000	0.36
06 B-2	3/8 inch	5.72	6.35	3.28	8.3	22.9	2.2	10.24	0.55	17,300	0.78
08 B-2	1/2 inch	7.75	8.51	4.45	11.8	30.2	2.1	13.92	1.00	31,800	1.40
10 B-2	5/8 inch	9.65	10.16	5.08	14.7	35.4	2.2	16.59	1.34	45,400	1.80
12 B-2	3/4 inch	11.68	12.07	5.72	16.1	41.4	2.6	19.46	1.78	57,900	2.44
16 B-2	1 inch	17.02	15.88	8.28	21.1	67.6	3.1	31.88	4.21	122,000	5.30
20 B-2	1 1/4 inch	19.56	19.05	10.19	26.3	77.6	3.1	36.45	5.91	187,000	7.45
24 B-2	1 1/2 inch	25.40	25.40	14.63	33.2	101.5	3.5	48.36	11.09	324,000	13.75
28 B-2	1 3/4 inch	30.99	27.94	15.90	37.0	125.2	3.6	59.56	14.81	380,000	17.30
32 B-2	2 inch	30.99	29.21	17.78	40.6	123.0	3.8	58.55	16.23	495,000	18.80

Triplex Roller Chains

Tel +44(0) 121 360 0155

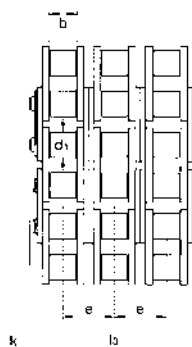

Cat No.†	Pitch P	Inside Width b min mm	Roller Dia. d1 max. mm	Pin Dia. d2 max. mm	Plate Depth g mm	Pin Length l2 max. mm	Con Pin Ext. k mm	Transverse Pitch e mm	Bearing Area cm ²	Tensile Strength N	Approx Weight kg/m
06 B-3	3/8 inch	5.72	6.35	3.28	8.3	32.8	2.2	10.24	0.83	25,400	1.18
08 B-3	1/2 inch	7.75	8.51	4.45	11.8	44.1	2.1	13.92	1.50	45,400	2.10
10 B-3	5/8 inch	9.65	10.16	5.08	14.7	51.9	2.2	16.59	2.02	68,100	2.85
12 B-3	3/4 inch	11.68	12.07	5.72	16.1	60.8	2.6	19.46	2.68	86,500	3.63
16 B-3	1 inch	17.02	15.88	8.28	21.1	99.4	3.1	31.88	6.32	182,000	7.80
20 B-3	1 1/4 inch	19.56	19.05	10.19	26.3	114.9	3.1	36.45	8.86	280,000	11.4
24 B-3	1 1/2 inch	25.40	25.40	14.63	33.2	149.5	3.5	48.36	16.64	485,000	20.5
28 B-3	1 3/4 inch	30.99	27.94	15.90	37.0	184.8	3.6	59.56	22.21	570,000	25.8
32 B-3	2 inch	30.99	29.21	17.78	40.6	181.2	3.8	58.55	24.34	743,000	27.9

Spares for Std. Chains

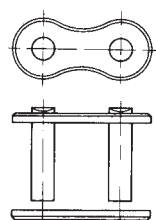

Pin Unit (Rivetting Outer Links)

Available all sizes of chain. Press fit unit to connect chains for maximum performance

Part Ref. 79

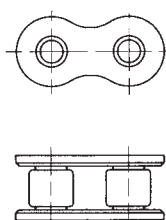

Roller Unit (Inner Link)

Available all sizes of chain to extend chain length or manufacture of special build chains.

Part Ref. 77

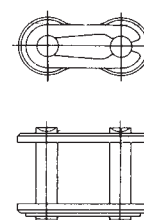

Connecting Link (Spring Clip Type)

Standard all chains to 1 inch pitch. Should be assembled with open end away from running direction of chain.

Part Ref. 76

Stainless Steel, Extended Pitch and Factory Standard Chains



Tel +44(0) 121 360 0155

Fax +44(0) 121 325 1079

Email sales@crossmorse.com

Straight Sideplate Roller Chains to British Standard Dimensions

These provide increased bearing support for conveying applications.

Cat. No.	Pitch P	Inside Width b min. mm	Roller ϕ d: max mm	Pin ϕ d: max mm	Plate Depth g mm	Pin Length k max mm	Bearing Area cm ²	Tensile Strength N	Weight kg/m
C12B-1	3/4 inch	11.68	12.07	5.72	16.1	27.3	0.89	29000	1.3
C16B-1	1 inch	17.02	15.88	8.28	21.0	41.5	2.10	64000	3.0
CL16B-1	1 inch	17.02	15.88	8.28	24.0	41.5	2.10	64000	3.2
C20B-1	1 1/4 inch	19.56	19.05	10.19	26.0	46.0	2.95	98000	4.1
C24B-1	1 1/2 inch	25.40	25.40	14.63	33.0	58.5	5.54	170000	7.9

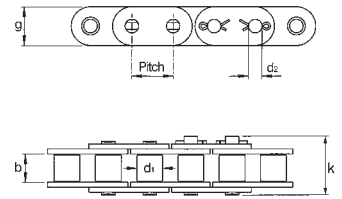

Special Metric Pitch Chains

Two sizes of chains produced to metric pitch employed on a number of continental machines. M20 is a custom design whilst M30 is 16B chain extended to 30mm pitch.

Cat. No.	Pitch P	Inside Width b min. mm	Roller ϕ d: max mm	Pin ϕ d: max mm	Plate Depth g mm	Pin Length k max mm	Bearing Area cm ²	Tensile Strength N	Weight kg/m
M20	20mm	16.00	12.00	6.00	19.0	35.5	1.36	35500	2.00
M30	30mm	17.02	15.88	8.28	20.8	41.5	2.10	63000	2.33

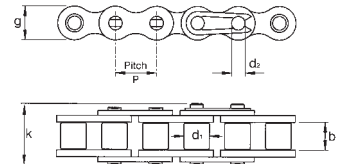

British Standard Double Pitch Chains

Double Pitch Chains use standard transmission chain pins, bushes, and rollers with link plates of double the pitch. These chains are used for both conveying and transmission on long centre distance drives, giving reduced weight and cost against the equivalent transmission chain.



Cat. No.	Pitch P	Inside Width b min.	Roller dia d:	Pin length l	Pin dia d2	Plate Depth g	Plate Thickness t	Bearing Area cm ²	Tensile Strength N	Weight kg/m
208B	1 inch	7.75	8.51	16.2	4.45	11.6	1.52	0.50	17800	0.46
210B	1 1/4 inch	9.65	10.16	19.3	5.08	14.5	1.60	0.67	22300	0.57
212B	1 1/2 inch	11.68	12.07	21.8	5.72	15.8	1.78	0.89	29000	0.75
216B	2 inch	17.02	15.88	34.0	8.28	20.5	4.06	2.10	64500	1.70
220B	2 1/2 inch	19.56	19.05	41.2	10.19	26.0	4.50	2.95	95000	2.50
224B	3 inch	25.40	25.40	53.4	14.63	33.0	6.00	5.54	160000	4.80

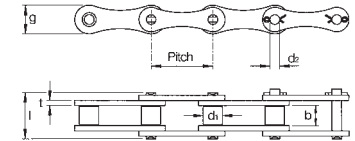

*Cat. No. equates to ISO 1275 Ref.

Special Conveying Chains

In addition to the standard attachments for roller chains, as shown on pages 16 and 17, Cross+Morse supply many special attachments for both standard pitch and extended pitch chains in standard steel and stainless steel materials. Cross+Morse have specialised in the many chains used for conveying applications in the Food, Beverage, Pharmaceutical, and Aerosol Can industries. Special production techniques enable early production of new designs, and replacement of existing obsolete products. Typical is the Foil Conveying Chain below.

Foil Conveying Chains

Foil conveying chains are based on 1/2" pitch B.S. Roller Chain type 08B1. They have been designed for the transport of foil, plastic and paper, the firm grip obtained with the chains maintaining tension in the materials when passed through heatforming or pressing operations. The base chain is electro-less nickel plated with the attachment parts all manufactured from stainless steel. In addition to simplex chain the attachments can be fitted to duplex chains enabling improved support and guidance of the assembly. The foil conveying chains operate on special design sprockets which open the clips as the chain passes around them. The material to be conveyed is fed into the open clips and retained as the clips close on leaving the sprocket. The material is discharged at the tail shaft of the conveyor by the reverse process.

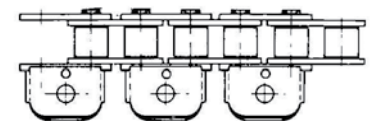

Foil Conveying Chain

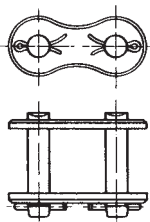
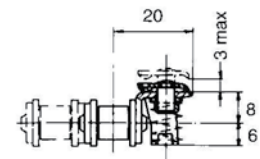

Connecting Link (Cottered Type)
For chains over 1" Pitch, for easy chain assembly

Part Ref. 75

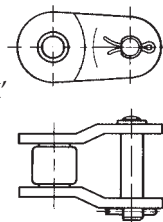

Single Crank Link
Used to make chains of Odd Pitch Lengths - Standard on chains over 1" pitch and optional on chains up to 1".

Part Ref. 87

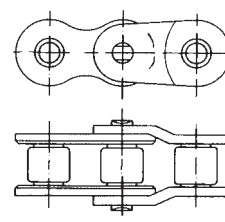

Double Crank Link
Preferred to Single Crank Link for small pitch chains. Available all chains to 1" pitch.

Part Ref. 86

British Standard Roller Chain Attachments



The attachments below are available on 72 hour service built into the base roller chain at spacings to suit the application, K & M attachments can be fitted to only one side of the chain or both sides (as illustrated). Attachments of different types can be fitted in one chain assembly. In addition to these standard attachments, specials to suit customers' specific requirements can be supplied. Attachments can be assembled into Duplex and Triplex Chains, as well as standard Simplex. Nickel Plated chains can also be supplied to order. All Standard Attachments are made basically to ISO 606 Standard to ensure full interchangeability.

Bent Attachments

K1 - Single Hole Bent Attachment

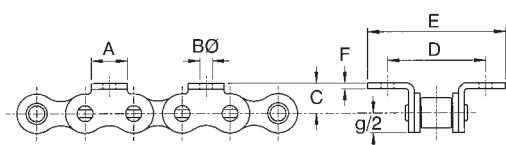

Base Chain Ref.	Pitch P	Attach Width A	Hole Dia B	Plate Height C	Transverse Pitch D	Overall Width E	Plate Thick F
08B-1	1/2"	11.5	4.2	8.9	23.8	36	1.5
10B-1	5/8"	12.8	5.3	10.3	31.8	45	1.5
12B-1	3/4"	16.6	7.1	13.5	38.1	58	1.8
16B-1	1"	20.0	6.7	15.9	50.8	73	3.2

K2 - Two Hole Bent Attachment

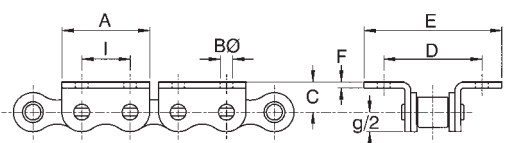

Base Chain Ref.	Pitch P	Attach Width A ₁	Hole Dia B	Plate Height C	Transverse Pitch D	Overall Width E	Plate Thick F	Hole Pitch I
08B-1	1/2"	23.4	4.9	8.9	25.4	40	1.5	12.7
10B-1	5/8"	28.6	5.3	10.3	31.8	49	1.5	15.9
12B-1	3/4"	34.0	6.5	13.5	38.1	52	1.8	19.1
16B-1	1"	46.0	6.7	15.9	50.8	73	3.2	25.4

Note:- If required plates can be supplied without holes, or with position/diameter of holes of non-standard sizes on short delivery.

Straight Attachments

M1 - Single Hole Straight Attachment

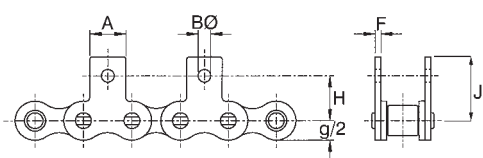

Base Chain Ref.	Pitch P	Attach Width A	Hole Dia B	Hole Height H	Plate Height J	Plate Thick F
08B-1	1/2"	11.5	4.2	12.7	19.0	1.5
10B-1	5/8"	12.8	5.3	15.9	22.6	1.5
12B-1	3/4"	16.6	7.1	22.2	31.9	1.8
16B-1	1"	20.0	6.7	23.0	34.0	3.2

M2 - Two Hole Straight Attachment

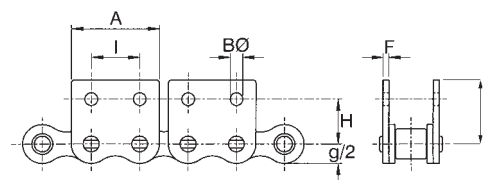

Base Chain Ref.	Pitch P	Attach Width A ₁	Hole Dia B	Hole Height H	Hole Pitch I	Plate Height J	Plate Thick F
08B-1	1/2"	23.4	4.9	13.0	12.7	20.8	1.5
10B-1	5/8"	28.6	5.3	16.5	15.9	24.9	1.5
12B-1	3/4"	34.0	6.5	21.0	19.1	28.2	1.8
16B-1	1"	46.0	6.7	23.0	25.4	34.0	3.2

All K & M attachments can be supplied without holes, or with the holes of different diameters and positions to standard. Also special shape attachments can be provided to customers drawings.

All dimensions in mm except where stated.

British Standard Roller Chain Attachments



Tel +44(0) 121 360 0155 Fax +44(0) 121 325 1079 Email sales@crossmorse.com

Extended Pin Attachments

The extended pins can be assembled into the chain at positions to suit customers applications, or supplied loose as rivetting outers or connecting links. Normally used in pairs to support transverse tubes (when chain should be ordered as matched pairs) or sometimes in single strands to support or attach other attachments.

Straight Parallel Pins extended one side only E1, or equally extended both sides of chain E2. Attachments available with short or long pins.

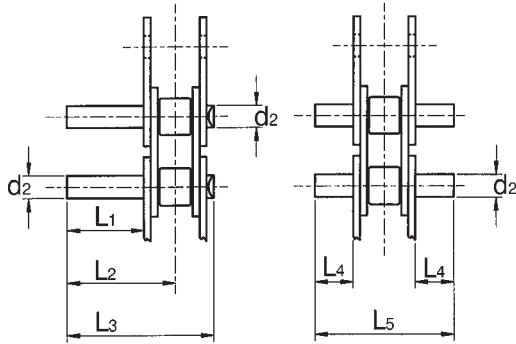

Attachment Ref.		E1 Short			E1 Long		E2 Short		E2 Long		
Chain Ref	Pitch	Pin to Ø	Extension	Pin ϕ	Pin Length	Extension	Pin Length	Extension	Pin Length	Extension	Pin Length
	P	d ₂	L ₁	L ₂	L ₃	L ₁	L ₃	L ₄	L ₅	L ₄	L ₅
06B-1	3/8"	3.28	11.1	16.7	22.9	21.3	33.2	5.9	22.9	11.0	33.2
08B-1	1/2"	4.45	14.5	21.8	30.0	28.4	43.9	7.7	30.0	14.7	43.9
10B-1	5/8"	5.08	17.8	26.1	35.3	34.4	51.9	9.4	35.3	17.7	51.9
12B-1	3/4"	5.72	20.7	30.5	41.3	40.2	60.8	10.9	41.3	20.6	60.8
16B-1	1"	8.28	33.8	49.9	67.4	65.7	99.3	17.6	67.4	33.6	99.3
20B-1	1 1/4"	10.19	38.3	57.2	77.6	75.6	114.8	20.0	77.6	38.6	114.8
24B-1	1 1/2"	14.63	50.3	74.7	101.3	-	-	26.3	101.3	-	-
32B-1	2"	17.78	61.0	90.5	122.9	-	-	31.9	122.9	-	-

Single pin extensions can be assembled projecting on alternate sides of chain. Special length pins available on short delivery time.

Parallel Pins with grooves for circlip fixture location. Available short pins E3 attachment, or long pins - E4 attachment

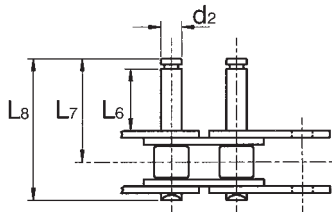

Attachment Ref.		E3 Short Groove Pin			E4 Long Groove Pin			
Chain Ref	Pitch	Pin to Ø	Attach Length	Pin ϕ	Pin Length	Attach Length	Pin ϕ	Pin Length
	P	d ₂	L ₆	L ₇	L ₈	L ₆	L ₇	L ₈
06B-1	3/8"	3.28	-	-	-	10.5	17.9	24.2
08B-1	1/2"	4.45	7.2	16.5	24.7	13.9	23.1	31.3
10B-1	5/8"	5.08	9.5	20.2	29.5	16.8	27.5	36.7
12B-1	3/4"	5.72	11.8	24.3	35.1	19.6	32.1	42.9
16B-1	1"	8.28	15.8	35.8	53.4	32.3	51.5	69.0

Stepped Pins to provide additional bearing support area, ref. E5 and (08B-1 only) E6 and E8.

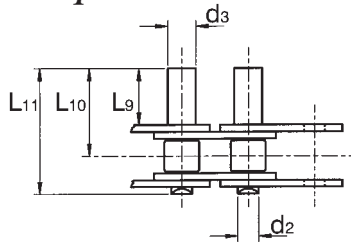

Chain Size	Pitch P	Attach Ref.	Pin dia d ₂	Step Pin dia d ₃	Step Pin Length L ₉	Pin to ϕ L ₁₀	Overall Length L ₁₁
08B-1	1/2"	E8	4.45	6.00	8.0	15.3	23.8
08B-1	1/2"	E6	4.45	6.00	15.0	22.3	30.8
08B-1	1/2"	E5	4.45	6.00	34.0	41.3	49.4
10B-1	5/8"	E5	5.08	6.00	26.0	34.3	43.5
12B-1	3/4"	E5	5.72	8.00	25.0	34.8	45.5
16B-1	1"	E5	8.28	10.00	25.0	41.1	58.6

Threaded Pins for rigidly attaching carriers, ref E9, used in Gatherers in Book Binding machines

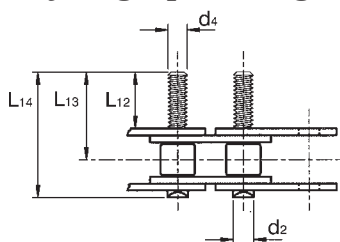

GATHERER CHAIN – 3/8" Pitch precision roller chain complete with an M4 threaded extended pin, one side every pitch. 'Gatherer Chain' is Synonymous with the book binding industry, this chain is manufactured to strict tolerances to produce a chain specifically for book binding applications.

Chain Size	Pitch P	Attach Ref.	Pin dia d ₂	Pin Thread dia d ₃	Step Pin Length L ₁₂	Pin to ϕ L ₁₃	Overall Length L ₁₄
12B-1	3/4"	E9	5.72	M4	10.0	19.8	30.8

All dimensions in mm except where stated.

Loose Link Assemblies for Standard Chain 06B to 16B Chains. Use chain size and extended pin ref. to identify.

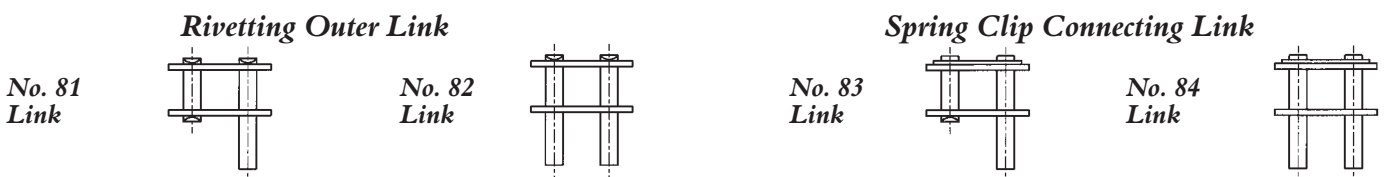

Many designs of special extended pins are manufactured for customer specific applications. Please consult Cross+Morse Engineering with your requirements.

British Standard Stainless Steel and Corrosion Resistant Roller Chains



Cross+Morse SS - Stainless Steel chain has been designed with a higher allowable load than other makes of stainless steel chain and is suitable for use in the most demanding applications. Where WATER, ACIDS, ALKALIS, CHEMICALS, HIGH HUMIDITY AND EXTREMES OF TEMPERATURE are encountered - conditions potentially destructive to ordinary transmission chain, SS chain provide the answer.



SS chain completely overcomes corrosion and wear problems normally encountered with standard chain used in such harsh conditions.

Remaining impervious to even the most severe chemicals required for cleaning and hygiene maintenance within food and pharmaceutical processing, SS chain offers proven high-performance and maintenance-free life time performance.

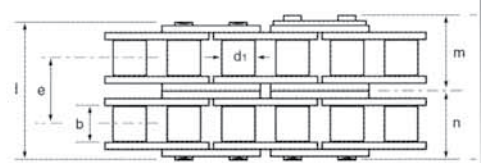
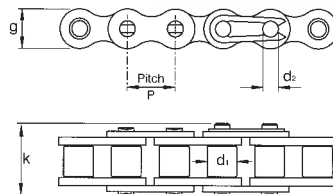

Cat No.	Pitch P inches	Inside Width mm	Roller Diameter d ₁ mm	Pin Diameter d ₂ mm	Plate Depth mm	Pin Lengths				Transverse Pitch mm	Bearing Area cm ²	Ultimate Tensile kN	Maximum Allowable kN	Approx Weight kg/m
						l max. mm	m2 max. mm	m mm	n mm					
BS Series Simplex Chains														
04B-1SS	6mm	2.80	4.00	1.85	5.0	7.4	10.2	6.5	3.7	-	0.07	2.2	0.08	0.12
05B-1SS	8mm	3.00	5.00	2.31	7.1	8.6	11.7	7.4	4.3	-	0.11	3.5	0.11	0.18
06B-1SS	3/8	5.72	6.35	3.28	8.3	12.6	14.2	7.1	6.3	-	0.28	6.2	0.40	0.41
08B-1SS	1/2	7.75	8.51	4.45	11.8	16.7	17.8	9.4	8.4	-	0.50	10.3	0.78	0.70
10B-1SS	5/8	9.65	10.16	5.08	14.7	19.0	20.6	11.1	9.5	-	0.67	15.7	1.02	0.96
12B-1SS	3/4	11.68	12.07	5.72	16.1	22.0	23.6	12.6	11.0	-	0.89	18.1	1.32	1.23
16B-1SS	1	17.02	15.88	8.28	21.1	35.1	38.2	20.6	17.6	-	2.10	42.2	3.09	2.60
20B-1SS	1.1/4	19.56	19.05	10.19	26.3	41.0	44.1	23.6	20.5	-	2.95	64.0	3.05	3.70
24B-1SS	1.1/2	25.40	25.40	14.63	33.3	53.4	56.9	30.2	26.7	-	5.54	110.0	5.60	6.90
BS Series Duplex Chains														
06B-2SS	3/8	5.72	6.35	3.28	8.3	22.9	23.6	12.2	11.4	10.24	0.55	12.2	0.57	0.78
08B-2SS	1/2	7.75	8.51	4.45	11.8	30.7	31.7	16.4	15.4	13.92	1.00	20.4	1.05	1.40
10B-2SS	5/8	9.65	10.16	5.08	14.7	35.6	37.2	19.4	17.8	16.59	1.34	31.2	1.38	1.80
12B-2SS	3/4	11.68	12.07	5.72	16.1	41.4	43.1	22.3	20.7	19.46	1.78	36.0	1.82	2.44
16B-2SS	1	17.02	15.88	8.28	21.1	67.6	70.1	36.5	33.5	31.88	4.21	84.0	4.30	5.30
20B-2SS	1.1/4	19.56	19.05	10.19	26.3	77.5	80.6	41.8	38.7	36.45	5.90	125.0	6.00	7.45

Chains from Stock, other chains to order.

Chains to Triplex Construction can also be supplied to special order.

Standard Chain components are all manufactured in 304 (18-8) Nickel Chrome Stainless Steel. The chains are suitable for temperatures up to 350°C, with intermittent peaks of 500°C, and also for the sub- zero conditions involved in food packaging.

Chains can also be supplied in 316 grade Stainless Steel for applications involving strong acids, or where a totally non-magnetic chain is required. Temperatures of 500°C, with intermittent peaks of 650°C are possible with these chains. These chains should only be used where conditions demand as they do not have the same wear life properties as the standard chain, and for this reason it is recommended that working loads should not exceed half those recommended for standard Stainless Steel Chain.

Alternate Corrosion Protection Treatments

For many applications plated chains, and standard chain with chemical surface treatment can provide the level of corrosion resistance at a lower cost. Cross and Morse offer the following standard treatments.

Aqua Proof Roller Chains

A special coating applied to chain components which offers excellent corrosion resistance without the hydrogen embrittlement problems associated with plating. The strength and working load values of the base chain are fully retained. Can be used in outdoor environments, seawater applications etc.

Cat. No.	Pitch Inches P	Inside Width mm b	Roller Diameter mm d ₁	Pin Diameter mm d ₂	Plate Depth mm g	Pin Length max. mm l ₁	Conn Pin Ext. mm k	Transverse Pitch mm e	Bearing Area cm ²	Tensile Strength N	Approx. Weight kg/m
06B1-AP	3/8	5.72	6.35	3.28	8.30	12.60	2.20		0.28	9.10	0.41
08B1-AP	1/2	7.75	8.51	4.45	11.80	16.20	2.10		0.50	18.20	0.70
10B1-AP	5/8	9.65	10.16	5.08	14.70	18.60	2.20		0.67	22.70	0.96
12B1-AP	3/4	11.68	12.07	5.72	16.10	21.90	2.60		0.89	29.00	1.23
16B1-AP	1	17.02	15.88	8.28	21.10	35.60	3.10		2.10	64.00	2.60



Nickel Plated BS Roller Chains

Electroless nickel plating is applied to standard carbon steel chain, offering protection to surfaces where mild corrosion is likely. The plated chain retains all the inherent properties of the base chain.

Cat. No.	Pitch Inches P	Inside Width mm b	Roller Diameter mm d ₁	Pin Diameter mm d ₂	Plate Depth mm g	Pin Length max. mm l ₁	Conn Pin Ext. mm k	Transverse Pitch mm e	Bearing Area cm ²	Tensile Strength N	Approx. Weight kg/m
06B1-N	3/8	5.72	6.35	3.28	8.30	12.60	2.20		0.28	9.10	0.41
08B1-N	1/2	7.75	8.51	4.45	11.80	16.20	2.10		0.50	18.20	0.70
10B1-N	5/8	9.65	10.16	5.08	14.70	18.60	2.20		0.67	22.70	0.96
12B1-N	3/4	11.68	12.07	5.72	16.10	21.90	2.60		0.89	29.00	1.23
16B1-N	1	17.02	15.88	8.28	21.10	35.60	3.10		2.10	64.00	2.60
20B1-N	1.1/4	19.56	19.05	10.19	26.30	41.00	3.10		2.95	98.00	3.70

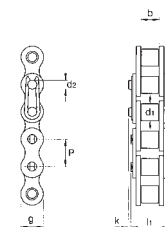

MolyPaul Treated Chains

A hard coating of dry lubricant, including MoS₂ and Graphite is chemically bonded to the surface of all chain components. The treated chain has excellent dry lubricant properties, with good corrosion resistance, and ability to work up to 200°C. Available all sizes of chains up to 1 1/2" pitch. The chains with corrosion protection are suitable for many outdoor applications including Car Washers, Automated Car Parking, Agricultural Equipment, Tanneries, and Marine environments. When used with additional lubrication long chain life can be achieved.

British Standard Stainless Steel and Corrosion Resistant Roller Chains



Tel +44(0) 121 360 0155

Fax +44(0) 121 325 1079

Email sales@crossmorse.com

Standard Attachments for Conveying Applications

The attachments shown on the opposite page enable standard Stainless Steel chains to be used in a variety of conveying applications. Available on a 72 hour service built into the base chain at spacings to suit the application. The K and M attachments can be fitted to one side of the chain only or both sides (as illustrated). Attachments of different designs can be fitted into one chain assembly. In addition to the standard attachments, custom made units are available on a short lead time, to meet customers specific requirements. Attachments can also be assembled into Duplex and Triplex Chains. If Attachment Chains are used in parallel on Conveying Applications they should be ordered as **matched pairs**.

Bent Attachments

K1 - Single Hole Bent Attachment

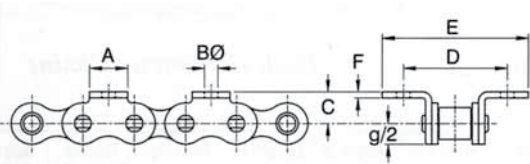

Base Chain Ref.	Pitch P	Attach Width A	Hole Dia B	Plate Height C	Transverse Pitch D	Overall Width E	Plate Thick F
08B-1	1/2"	11.5	4.2	8.9	23.8	36	1.5
10B-1	5/8"	12.8	5.3	10.3	31.8	45	1.5
12B-1	3/4"	16.6	7.1	13.5	38.1	58	1.8

K2 - Two Hole Bent Attachment

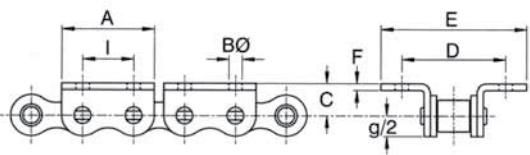

Base Chain Ref.	Pitch P	Attach Width A	Hole Dia B	Plate Height C	Transverse Pitch D	Overall Width E	Plate Thick F	Hole Pitch I
08B-1	1/2"	23.4	4.9	8.9	23.8	40	1.5	12.7
10B-1	5/8"	28.6	5.3	10.3	31.8	49	1.5	15.9
12B-1	3/4"	34	6.5	13.5	38.1	52	1.8	19.1

Straight Attachments

M1 - Single Hole Straight Attachment

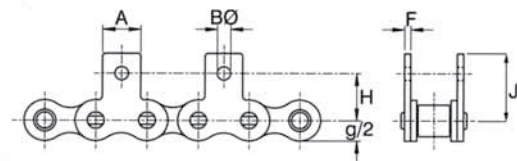

Base Chain Ref.	Pitch P	Attach Width A	Hole Dia B	Hole Height H	Plate Height J	Plate Thick F
08B-1	1/2"	11.5	4.2	12.7	19.0	1.5
10B-1	5/8"	12.8	5.3	15.9	22.9	1.5
12B-1	3/4"	16.6	7.1	22.2	31.9	1.8

M2 - Two Hole Straight Attachment

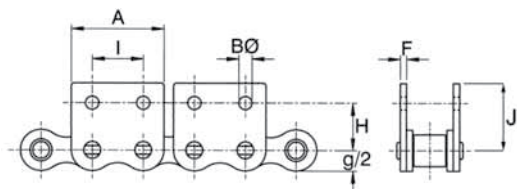

Base Chain Ref.	Pitch P	Attach Width A	Hole Dia B	Hole Height H	Plate Height J	Plate Thick F	Plate Thick F
08B-1	1/2"	23.4	4.9	13.0	12.7	20.8	1.5
10B-1	5/8"	28.6	5.3	16.5	15.9	24.9	1.5
12B-1	3/4"	34.0	6.5	21.0	19.1	28.2	1.8

Straight Parallel Pins extended one side only E1, or equally extended both sides of chain E2. Attachments available with short or long pins.

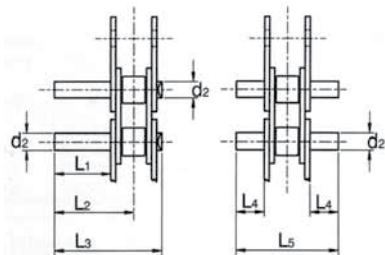

Attachment Ref.		E1 Short			E1 Long		E2 Short		E2 Long		
Chain Ref	Pitch	Pin to Ø	Extension	Pin Ø	Pin Length	Extension	Pin Length	Extension	Pin Length	Extension	Pin Length
	P	d ₂	L ₁	L ₂	L ₃	L ₁	L ₃	L ₄	L ₅	L ₄	L ₅
08B-1	1/2"	4.45	14.8	21.8	30.0	28.8	44.0	7.9	30.0	14.9	44.0
10B-1	5/8"	5.08	17.8	26.1	35.4	34.4	52.0	9.4	35.4	17.8	52.0
12B-1	3/4"	5.72	20.7	30.4	41.4	40.1	60.8	10.9	41.4	20.7	60.8
16B-1	1"	8.28	33.8	49.7	67.5	65.6	99.4	17.9	67.5	33.8	99.4

Parallel Pins with grooves for circlip fixture location. Available short Pins E3 attachment, or long pins - E4 attachment

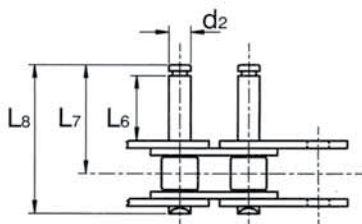

Attachment Ref.		E3 Short Groove Pin			E4 Long Groove Pin			
Chain Ref	Pitch	Pin to Ø	Attach Length	Pin Ø	Pin Length	Attach Length	Pin Ø	Pin Length
	P	d ₂	L ₆	L ₇	L ₈	L ₆	L ₇	L ₈
08B-1	1/2"	4.45	7.2	17.0	25.1	14.2	23.1	31.3
10B-1	5/8"	5.08	9.5	21.2	30.5	17.0	27.3	36.6
12B-1	3/4"	5.72	11.8	25.3	36.3	19.5	32.0	43.0
16B-1	1"	8.28	15.8	36.9	54.7	32.2	51.9	69.1

American Standard Precision Roller Chains Simplex (Single Strand) Construction



Conforming to ANSI B29.1 and ISO 606*

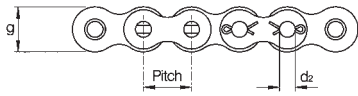

Standard Roller Chains

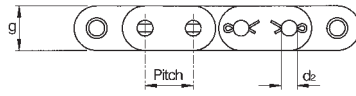

Straight Sideplate Roller Chains

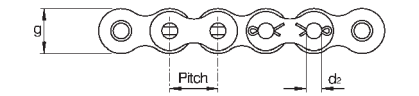

Bush (Rollerless) Chains

*ISO 606 covers Standard Series Chains only

ANSI No.	Pitch P inches	Inside Width b min mm	Roller Ø d1 max. mm	Pin Ø d2 max. mm	Plate Depth g mm	Rivet Pin Length l max. mm	Length to Cotter Pin m mm	Length to Rivet Pin n mm	Bearing Area cm ²	Tensile Strength N	Approx Weight kg/m
*25	1/4	3.18	3.30 ¹⁾	2.29	5.9	7.9	4.9	3.9	0.11	3,500	0.13
*35	3/8	4.77	5.08 ¹⁾	3.58	9.0	12.0	8.7	6.0	0.27	8,400	0.31
41	1/2	6.35	7.77	3.58	9.9	13.2	9.4	6.6	0.32	8,000	0.42
40	1/2	7.85	7.95	3.96	11.8	16.6	10.7	8.3	0.44	14,800	0.62
50	5/8	9.40	10.16	5.08	15.0	20.2	14.3	10.1	0.70	24,400	1.04
60	3/4	12.60	11.91	5.94	18.0	25.0	16.3	12.5	1.06	34,400	1.48
80	1	15.80	15.88	7.92	24.0	32.6	18.8	16.3	1.79	64,500	2.50
100	1 1/4	19.00	19.05	9.53	30.0	39.2	23.2	19.6	2.62	100,000	3.76
120	1 1/2	25.25	22.23	11.10	36.0	49.4	29.0	24.7	3.94	130,000	5.50
140	1 3/4	25.25	25.40	12.70	42.0	53.0	31.0	26.5	4.72	177,000	7.20
160	2	31.55	28.58	14.27	48.0	63.2	37.1	31.6	6.50	227,000	9.80
180	2 1/4	35.50	35.71	17.45	54.5	71.5	44.2	35.8	8.87	320,000	13.0
200	2 1/2	37.85	39.68	19.85	59.5	77.0	47.3	38.5	10.90	360,000	16.3
240	3	47.35	47.63	23.80	72.0	95.5	57.7	47.8	16.15	520,000	25.3

Standard Series Chains (complying to ANSI b29.1)

Can be supplied also to full A.P.I. Specification with certified approval

• ANSI 25 and 35 are Bush Chains to ISO 1395

1) Bush Diameter

Heavy Series and High Endurance Chains

Morse High Strength Roller Chains are designed to meet the instantaneous peak loading requirements of all applications ranging from rugged construction equipment to elevated personnel carriers.

There are two series of chains, both operate on standard ANSI sprocket. The 'H' series have link plates of increased thickness to resist fatigue failure from shock and pulsating loads. Chains prefixed '8' have through hardened pins for additional strength where very high shock loads are encountered.

60H	3/4	12.60	11.91	5.94	18.0	28.3	16.6	14.2	1.15	34,000	1.70
80H	1	15.80	15.88	7.92	24.0	35.9	20.4	18.0	1.92	64,500	2.88
100H	1 1/4	19.00	19.05	9.53	30.0	42.5	25.0	21.3	2.77	100,000	4.55
120H	1 1/2	25.25	22.23	11.10	36.0	52.7	30.8	26.4	4.12	130,000	6.62
140H	1 3/4	25.25	25.40	12.70	42.0	56.0	32.6	28.0	4.93	177,000	8.45
160H	2	31.55	28.58	14.27	48.0	66.2	38.7	33.1	6.69	227,000	10.9
180H	2 1/4	35.50	35.71	17.45	54.5	75.0	44.5	37.5	9.14	320,000	13.6
200H	2 1/2	37.85	39.68	19.85	59.5	92.4	51.3	46.2	11.54	360,000	20.1

8-60H	3/4	12.60	11.91	5.94	18.0	28.3	16.6	14.2	1.15	40,000	1.70
8-80H	1	15.80	15.88	7.92	24.0	35.9	20.4	18.0	1.92	84,000	2.88
8-100H	1 1/4	19.00	19.05	9.53	30.0	42.5	25.0	21.3	2.77	120,500	4.55
8-120H	1 1/2	25.25	22.23	11.10	36.0	52.7	30.8	26.4	4.12	168,000	6.62
8-140H	1 3/4	25.25	25.40	12.70	42.0	56.0	32.6	28.0	4.93	224,000	8.45
8-160H	2	31.55	28.58	14.27	48.0	66.2	38.7	33.1	6.69	280,000	10.9
8-180H	2 1/4	35.50	35.71	17.45	54.5	75.0	44.5	37.5	9.14	380,000	13.6
8-200H	2 1/2	37.85	39.68	19.85	59.5	92.4	51.3	46.2	11.54	415,000	20.1

Straight Side Plate Chains

Provide increased bearing area for conveying applications, when sliding on guides. Operate on std. ANSI sprockets.

C40	1/2	7.85	7.95	3.96	11.7	16.6	10.7	8.3	0.44	14,800	0.67
C60	3/4	12.60	11.91	5.94	17.3	24.9	16.3	12.5	1.06	34,000	1.57
C80	1	15.80	15.88	7.92	24.2	32.6	18.8	16.3	1.79	64,500	2.79
C100	1 1/4	19.00	19.05	9.53	28.7	39.2	23.2	19.6	2.62	100,000	4.42
C120	1 1/2	25.25	22.23	11.10	36.1	49.4	29.0	24.7	3.94	130,000	6.55

Bush Chains

Standard ANSI Simplex chains assembled without rollers for reduced weight. Used on slow speed drives and lifting equipment such as, fork lift trucks.

ANSI No.	Pitch P inches	Inside Width b min mm	Roller Ø d1 max. mm	Pin Ø d2 max. mm	Plate Depth g mm	Rivet Pin Length l max. mm	Length to Cotter Pin m mm	Length to Rivet Pin n mm	Bearing Area cm ²	Tensile Strength N	Approx Weight kg/m
65	3/4	12.60	8.36	5.94	18.0	25.0	16.3	12.5	1.06	34,000	1.10
85	1	15.80	11.23	7.92	24.0	32.6	18.8	16.3	1.79	64,500	1.95
105	1 1/4	19.00	13.49	9.53	30.0	39.2	23.2	19.6	2.62	100,000	3.10
125	1 1/2	25.25	15.82	11.10	36.0	49.4	29.0	24.7	3.94	130,000	4.40

Detachable Chains

Detachable Chain can be supplied for chains of 3/4" pitch and above, in standard series, heavy series and high endurance series, add suffix 'C' to Part No. - e.g. 2" Pitch Triplex Detachable Chain - Ref. 160 - 3C.

Spares for Std. Chains

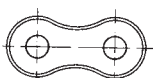

Pin Unit
(Rivetting Outer Links)

Available all sizes of chain. Press fit unit to connect chains for maximum performance

Part Ref. 79



Roller Unit
(Inner Link)

Available all sizes of chain to extend chain length or manufacture of special build chains.

Part Ref. 77

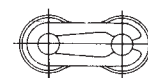

Connecting Link
(Spring Clip Type)

Standard all chains to 3/4" inch pitch. Should be assembled with open end away from running direction of chain.

Part Ref. 76

American Standard Precision Roller Chains Multi-Strand Constructions

Conforming to ANSI B29.1 and ISO 606*

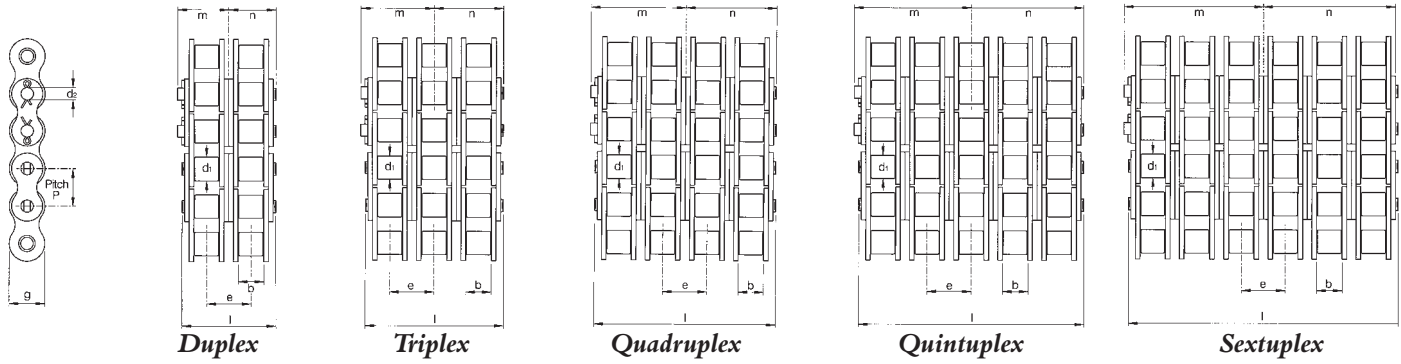

All chains available to full A.P.I. specifications with certified approval. *ISO 606 covers Duplex and Triplex construction only.

Duplex Chains

• 25-2 & 35-2 Bush Chains to ISO 1395

1) Bush diameter.

Triplex Chains

• 25-3 & 35-3 Bush Chains to ISO 1395

1) Bush diameter.

Quadruplex Chains

Quintuplex Chains

Sextuplex Chains

All dimensions in mm.

ANSI No.	Pitch P inches	Inside Width b min. mm	Roller Ø d ₁ max. mm	Pin Ø d ₂ max. mm	Plate Depth g mm	Transverse Pitch e mm	Rivet Pin Length l max. mm	Length to Cotter Pin m mm	Length to Rivet Pin n mm	Bearing Area cm ²	Tensile Strength N	Weight Approx. kg/m
•25-2	3/4	3.18	3.30 ₁₁	2.29	5.9	6.40	14.3	7.9	7.2	0.22	6,800	0.26
•35-2	3/8	4.77	5.08 ₁₁	3.59	9.0	10.13	22.0	11.9	11.0	0.54	16,800	0.65
40-2	1/2	7.85	7.95	3.96	11.8	14.38	30.9	16.8	15.2	0.88	29,600	1.22
50-2	5/8	9.40	10.16	5.08	15.0	18.11	38.3	21.2	19.2	1.40	48,800	2.00
60-2	3/4	12.60	11.91	5.94	18.0	22.78	48.1	26.4	24.1	2.12	68,000	2.85
80-2	1	15.80	15.88	7.92	24.0	29.29	61.8	33.6	30.9	3.58	129,000	5.00
100-2	1 1/4	19.00	19.05	9.53	30.0	35.76	75.3	41.3	37.7	5.24	200,000	7.60
120-2	1 1/2	25.25	22.23	11.10	36.0	45.44	95.3	52.0	47.6	7.88	260,000	10.8
140-2	1 3/4	25.25	25.40	12.70	42.0	48.87	102.6	55.6	51.3	9.44	354,000	14.2
160-2	2	31.55	28.58	14.27	48.0	58.55	122.6	66.7	61.4	13.00	454,000	19.0
180-2	2 1/4	35.50	35.71	17.48	54.5	65.84	137.2	74.7	68.6	17.75	640,000	26.2
200-2	2 1/2	37.85	39.68	19.84	59.5	71.55	150.9	83.4	75.4	21.80	720,000	32.0
240-2	3	47.35	47.63	23.80	72.0	87.83	184.1	99.5	92.1	32.30	1,040,000	49.5
•25-3	3/4	3.18	3.30 ₁₁	2.29	5.9	6.40	20.6	11.2	10.4	0.33	10,200	0.39
•35-3	3/8	4.77	5.08 ₁₁	3.59	9.0	10.13	32.2	17.9	16.1	0.80	25,200	0.97
40-3	1/2	7.85	7.95	3.96	11.8	14.38	45.2	24.6	22.4	1.32	44,500	1.83
50-3	5/8	9.40	10.16	5.08	15.0	18.11	56.4	30.6	28.2	2.10	73,300	2.97
60-3	3/4	12.60	11.91	5.94	18.0	22.78	70.9	38.1	35.5	3.18	102,100	4.35
80-3	1	15.80	15.88	7.92	24.0	29.29	91.1	48.4	45.6	5.73	193,600	7.90
100-3	1 1/4	19.00	19.05	9.53	30.0	35.76	111.1	59.2	55.6	7.86	300,000	11.4
120-3	1 1/2	25.25	22.23	11.10	36.0	45.44	140.7	74.7	70.4	11.82	390,000	15.8
140-3	1 3/4	25.25	25.40	12.70	42.0	48.87	151.6	80.2	75.8	14.16	531,000	21.5
160-3	2	31.55	28.58	14.27	48.0	58.55	181.2	96.1	90.6	19.50	681,000	26.3
180-3	2 1/4	35.50	35.71	17.48	54.5	65.84	203.0	107.2	101.6	26.63	960,000	39.6
200-3	2 1/2	37.85	39.68	19.84	59.5	71.55	222.4	119.5	111.2	32.70	1,080,000	47.7
240-3	3	47.35	47.63	23.80	72.0	87.83	272.0	143.4	136.0	48.45	1,560,000	73.8
40-4	1/2	7.85	7.95	3.96	11.8	14.38	59.6	31.8	29.6	1.76	59,300	2.44
60-4	3/4	12.60	11.91	5.94	18.0	22.78	93.7	49.3	46.9	4.24	136,000	5.86
80-4	1	15.80	15.88	7.92	24.0	29.29	120.4	62.8	60.2	7.16	232,000	10.07
100-4	1 1/4	19.00	19.05	9.53	30.0	35.76	146.8	77.0	73.4	10.48	384,000	15.0
120-4	1 1/2	25.25	22.23	11.10	36.0	45.44	186.1	97.3	93.1	15.76	520,000	22.6
140-4	1 3/4	25.25	25.40	12.70	42.0	48.87	200.4	104.8	100.2	18.88	705,000	29.9
160-4	2	31.55	28.58	14.27	48.0	58.55	239.7	125.5	119.9	26.00	908,000	38.8
200-4	2 1/2	37.85	39.68	19.84	59.5	71.55	293.9	155.2	147.0	43.60	1,440,000	63.3
240-4	3	47.35	47.63	23.80	72.0	87.83	359.8	187.3	179.9	64.60	2,080,000	98.5
60-5	3/4	12.60	11.91	5.94	18.0	22.78	116.5	60.6	58.3	5.30	170,000	7.32
80-5	1	15.80	15.88	7.92	24.0	29.29	149.7	77.5	74.8	9.31	290,000	12.6
100-5	1 1/4	19.00	19.05	9.53	30.0	35.76	182.6	95.0	91.3	13.10	480,000	18.8
120-5	1 1/2	25.25	22.23	11.10	36.0	45.44	231.6	120.1	115.8	19.70	680,000	28.2
140-5	1 3/4	25.25	25.40	12.70	42.0	48.87	249.3	128.6	124.7	23.60	920,000	36.2
160-5	2	31.55	28.58	14.27	48.0	58.55	298.3	154.0	149.2	32.50	1,160,000	52.9
60-6	3/4	12.60	11.91	5.94	18.0	22.78	139.3	81.9	79.5	6.36	204,000	8.78
80-6	1	15.80	15.88	7.92	24.0	29.29	178.9	102.0	99.4	11.46	348,000	15.10
100-6	1 1/4	19.00	19.05	9.53	30.0	35.76	218.4	122.9	119.2	15.72	576,000	22.5
120-6	1 1/2	25.25	22.23	11.10	36.0	45.44	277.0	153.1	148.8	23.64	816,000	33.9
140-6	1 3/4	25.25	25.40	12.70	42.0	48.87	318.1	163.0	159.0	28.32	1,105,000	43.4
160-6	2	31.55	28.58	14.27	48.0	58.55	376.8	193.2	188.4	39.00	1,395,000	58.1

Detachable Chains

Detachable Chain can be supplied for chains 3/4" pitch and above. Add suffix 'C' to Part No. e.g. Ref 160-3C for 2" pitch Triplex Detachable Chain

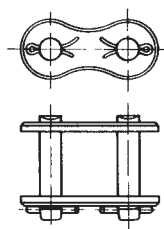

Connecting Link (Cottered Type)

For chains 3/4" Pitch and over for easy assembly of chains. Normally fitted slip fit plate except high endurance chains which are interference fit. Part Ref. 75

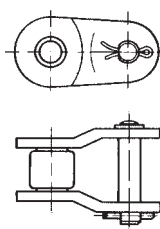

Single Crank Link

Used to make chains of Odd Pitch Lengths - Standard on all size ANSI Chains. Part Ref. 87

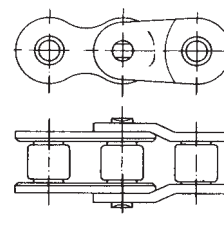

Double Crank Link

Preferred to Single Crank Link for small pitch chains. Available Chains to 3/4" pitch. Part Ref. 86

Tel +44(0) 121 360 0155

Fax +44(0) 121 325 1079

Email sales@crossmorse.com

American Standard Roller Chains Attachments



The following attachments are available built into the base roller chain at spacing to suit the application. B & S attachments can be fitted on one side only of chain or both sides (as illustrated). When fitted one side they are referred to as B1 or S1 attachments, but when fitted both sides they are referred to as B2 or S2 attachments. The attachments can also be fitted to Duplex chains, and different types of attachment can be mixed within one chain.

Bent Attachments

B1 - Single Hole Bent Attachment fitted one side chain only.

B2 - Single Hole Bent Attachments fitted both sides of chain (as illustrated).

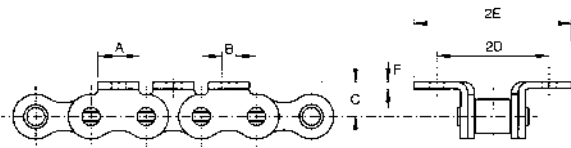

Attachments available for both inner (roller) link and outer (pin) link. Connecting links with attachment as rivetted link, or as loose link can be supplied. All sizes available as rivetted construction, but ANSI 60 and larger can optionally be supplied as cottered construction if specified.

Chain ANSI No.	Pitches inches	Roller Ø max.	Attach Width A	Hole dia B	Plate Height C	Hole-offset D	Plate Width E	Plate Thick F	Add Wt B1 att grms
• 35	3/8"	5.08 ¹⁾	7.94	2.78	6.35	9.52	13.50	1.27	0.9
41	1/2"	7.77	9.53	3.17	7.14	11.90	17.46	1.27	1.4
40	1/2"	7.95	9.53	3.37	7.94	12.70	18.25	1.52	1.4
50	5/8"	10.16	12.70	5.16	10.32	15.87	23.02	2.03	3.6
60	3/4"	11.91	15.87	5.16	11.90	19.05	27.39	2.39	5.9
80	1	15.88	19.05	6.65	15.87	25.40	35.32	3.18	12.2
100	1 1/4"	19.05	25.40	8.33	19.84	31.75	42.86	3.96	25.0
120	1 1/2"	22.23	28.57	9.92	23.02	38.10	52.40	4.75	37.2
140	1 3/4"	25.40	34.92	11.51	28.57	44.45	57.55	5.56	64.0
160	2	28.58	38.10	13.10	31.75	50.80	68.30	6.35	90.0

• ANSI 35 is Bush Chain
1) Bush diameter

All dimensions are in mm

Straight Attachments

S1 - Single Hole Straight Attachment fitted one side chain only.

S2 - Single Hole Straight Attachments fitted both sides of chain (as illustrated).

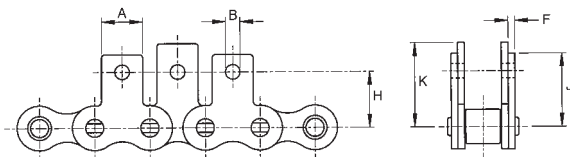

Attachments available for both inner (roller) link and outer (pin) link. Connecting links with attachment as rivetted link, or as loose link can be supplied. All sizes available as rivetted construction, but ANSI 60 and larger can optionally be supplied as cottered construction if specified.

Chain ANSI No.	Pitches inches	Roller Ø max.	Attach Width A	Hole dia B	Hole Height H	Outer Plate Ht. J	Inner Plate Ht. K	Plate Thick F	Add Wt S1 att grms
• 35	3/8"	5.08 ¹⁾	7.94	2.78	9.53	13.50	13.50	1.27	0.9
41	1/2"	7.77	9.53	3.17	12.30	17.85	17.85	1.27	1.4
40	1/2"	7.95	9.53	3.37	12.70	17.45	19.05	1.52	1.4
50	5/8"	10.16	12.70	5.16	15.87	22.65	24.60	2.03	3.6
60	3/4"	11.91	15.87	5.16	18.25	26.20	28.60	2.39	5.9
80	1	15.88	19.05	6.65	24.60	34.15	38.10	3.18	12.2
100	1 1/4"	19.05	25.40	8.33	31.75	42.10	46.45	3.96	25.0
120	1 1/2"	22.23	28.57	9.92	36.52	49.20	54.00	4.75	37.2
140	1 3/4"	25.40	34.92	11.51	44.45	57.95	63.50	5.56	64.0
160	2	28.58	38.10	13.10	50.80	66.30	73.00	6.35	90.0

• ANSI 35 is Bush Chain
1) Bush diameter

All dimensions are in mm

Extended Pin Attachments

D1 - One Pin of outer link extended.

D3 - Both Pins of outer link extended.

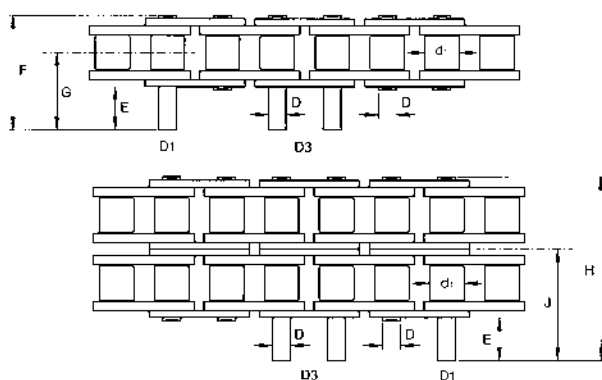

Chain ANSI No.	Pitches inches	Roller Ø max.	Pin Ø D	Pin Extension E	Simplex Pin Lth. F	Simplex Pin to C/L ² G	Duplex Pin Lth. H	Duplex Pin to C/L ² J
• 35	3/8"	5.08 ¹⁾	3.58	9.53	20.64	14.72	30.95	19.95
41	1/2"	7.77	3.58	9.53	21.83	15.33	-	-
40	1/2"	7.95	3.96	9.53	24.60	16.60	38.90	23.47
50	5/8"	10.16	5.08	11.90	30.95	20.92	49.21	30.07
60	3/4"	11.91	5.94	14.30	38.10	25.53	61.12	37.08
80	1	15.88	7.92	19.05	50.00	33.82	79.37	48.48
100	1 1/4"	19.05	9.53	23.80	61.52	41.77	98.03	59.65
120	1 1/2"	22.23	11.10	28.60	76.20	51.31	121.44	73.83
140	1 3/4"	25.40	12.70	33.35	84.55	57.67	133.35	82.03
160	2	28.58	14.27	38.10	99.22	67.19	157.95	96.45

• ANSI 35 is Bush Chain

1) Bush diameter
2) Approx dimensions

All sizes available as rivetted construction, but ANSI 60 and larger can optionally be supplied as cottered construction if specified.

American Standard Attachment Chains and Corrosion Resistance Chains



Rollerless Hollow Pin Chains to ANSI Dimensions

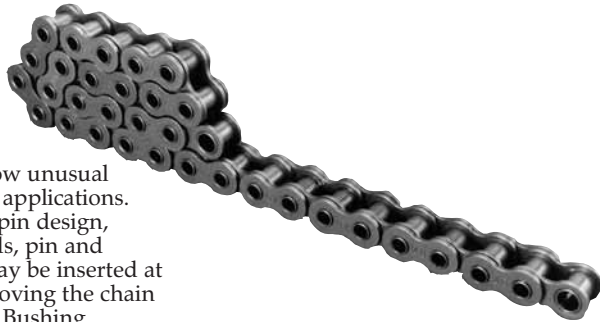

Hollow Pin Chains allow unusual flexibility for conveyor applications. Because of the hollow pin design, many types of crossrods, pin and custom attachments may be inserted at any point without removing the chain from the drive system. Bushing diameters are the same as comparable chain rollers. These chains operate on standard sprockets. Standard packages contain two matched 10' lengths. When used on parallel strand conveyors, these strands should be installed directly opposite each other. A two-pitch offset section can be ordered to accommodate applications where an odd number of link is required.

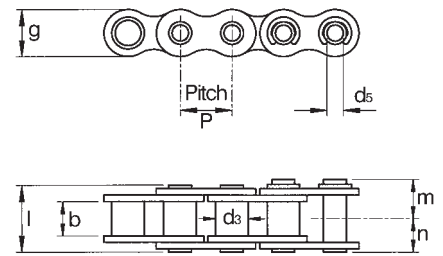

Cat. No.	Pitch P inches	Inside Width b min. mm	Bush Ø d ₃ max. mm	Bore Ø d ₅ max. mm	Plate Depth g mm	Rivet Pin Length l max. mm	Length to Cotter Pin m mm	Length to Rivet Pin n mm	Tensile Strength N	Weight Approx. kg/m
40HP	1/2	7.85	7.95	4.01	11.8	16.6	9.4	8.3	10,000	0.57
50HP	5/8	9.40	10.16	5.15	15.0	20.2	11.7	10.1	14,800	0.94
60HP	3/4	12.60	11.91	6.02	18.0	24.7	14.5	12.4	24,000	1.31
80HP	1	15.80	15.88	8.07	24.0	31.0	17.8	15.5	34,000	2.32

ANSI Stainless Steel Roller Chains

Standard chains are manufactured from 18-8 (304) stainless steel. These chains can be used in corrosive environments, and at temperatures up to 500°C. They are well suited to the high moisture, high temperature conditions found in many food preparation and packaging applications. For improved wear life chains with round parts manufactured from precipitation hardened 400 Series steels can be supplied. These chains have slightly less corrosion resistance, and can only operate up to 325°C.

Extended pin, K1 and M1 attachments in 18-8 materials can be provided assembled into chains, against specific order.

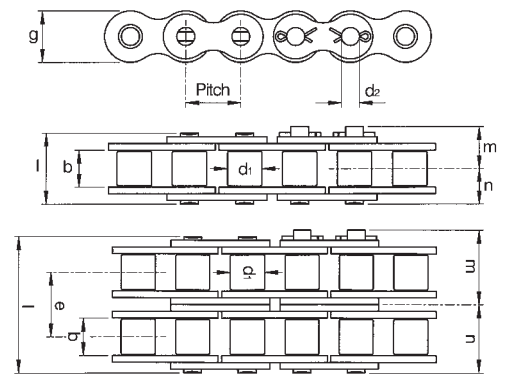

Chain No.	Pitch P inches	Inside Width mm	Roller Diameter mm	Pin Diameter mm	Plate Depth mm	Pin Lengths				Transverse Pitch mm	Bearing Area cm ²	Ultimate Tensile kN	Max Allowable kN	Approx. Weight kg/m
						l max. mm	m2 max. mm	m mm	n mm					
American Standard Simplex Chains														
ANSI 25 1)	1/4	3.18	3.30	2.29	5.9	7.8	8.8	4.9	3.9	-	0.11	2.8	0.11	0.13
ANSI 35 1)	3/8	4.78	5.08	3.58	9.0	12.2	13.7	7.6	6.1	-	0.27	5.7	0.26	0.34
ANSI 40	1/2	7.95	7.92	3.96	11.7	17.0	18.5	10.0	8.5	-	0.44	11.1	0.66	0.62
ANSI 50	5/8	9.53	10.16	5.08	14.6	20.8	22.3	11.9	10.4	-	0.70	17.6	1.02	1.01
ANSI 60	3/4	12.70	11.91	5.95	17.5	26.0	27.9	14.9	13.0	-	1.06	24.5	1.54	1.48
ANSI 80	1	15.88	15.88	7.93	23.4	32.8	35.5	19.1	16.4	-	1.79	42.3	2.65	2.52
ANSI 100	1 1/4	19.05	19.05	9.53	29.3	40.0	43.3	23.3	20.0	-	2.62	51.0	3.82	3.91
ANSI 120	1 1/2	25.40	22.23	11.10	35.1	50.4	54.2	29.0	25.2	-	3.94	68.6	4.66	5.76
ANSI 160	2	31.75	28.58	14.28	46.7	64.4	68.7	36.5	32.2	-	6.50	109.8	6.37	9.79
American Standard Duplex Chains														
ANSI 35-2 1)	3/8	4.78	5.08	3.58	9.0	22.33	23.8	12.7	11.2	10.13	0.54	10.4	0.52	0.65
ANSI 40-2	1/2	7.95	7.92	3.96	11.7	31.38	32.9	17.2	15.7	14.38	0.88	22.2	0.88	1.22
ANSI 50-2	5/8	9.53	10.16	5.08	14.6	38.91	40.4	21.0	19.5	18.11	1.40	35.2	1.36	2.00
ANSI 60-2	3/4	12.70	11.91	5.95	17.5	48.78	50.7	26.3	24.4	22.78	2.12	48.8	2.06	2.85
ANSI 80-2	1	15.88	15.88	7.93	23.4	62.09	64.8	33.7	31.0	29.29	3.58	84.5	3.55	5.00
ANSI 100-2	1 1/4	19.05	19.05	9.53	29.3	75.76	79.1	41.2	37.9	35.76	5.24	101.8	5.10	7.60

• Bush Chains. 1) Bush Diameter. **Bold Type** – Chains from Stock, other chains to order.

Nickel Plated Roller Chains to ANSI Standards

Chain components are electroless nickel plated to provide protection for mildly corrosive areas. Chain retains all physical properties of base chain. Attachments can be supplied to special order.

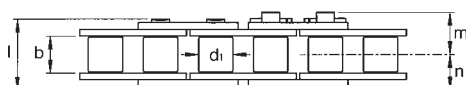
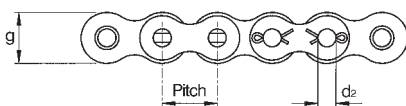

Aat. No.	Pitch P inches	Inside Width b min. mm	Roller Ø d ₁ max. mm	Pin Ø d ₂ max. mm	Plate Depth g mm	Length to Cotter Pin m mm	Length to Rivet Pin n mm	Bearing Area cm ²	Tensile Strength N	Weight Approx. kg/m
•35N	3/8	4.77	5.08 ¹⁾	3.58	9.0	8.7	6.0	0.27	8,400	0.31
40N	1/2	7.85	7.95	3.96	11.8	10.7	8.3	0.44	14,800	0.62
50N	5/8	9.40	10.16	5.08	15.0	14.3	10.1	0.70	24,400	1.01
60N	3/4	12.60	11.91	5.94	18.0	16.3	12.5	1.06	34,400	1.48

• Bush Chains.
1) Bush Diameter.
Chains available rivetted construction only.

Tel +44(0) 121 360 0155 Fax +44(0) 121 325 1079

Email sales@crossmorse.com

Maintenance Free American Standard Roller Chains



Email sales@crossmorse.com Fax +44(0) 121 325 1079 Tel +44(0) 121 360 0155

O-Ring Roller Chain

Morse O-Ring Chain is designed for those difficult applications where lubrication is inconvenient, impractical or expensive. The O-Rings between roller unit and pin seal in a special lubricant, so wear on internal pins and bushes is minimised. The O-Rings also keep out dust and other abrasive elements, thus protecting pins and bushes from damage. Retention of lubricant reduces friction, heat, wear and downtime.

Life of O-Ring chains can be minimised by occasional removal from drive and cleaning with paraffin or mineral spirits. After cleaning chain must be soaked in SAE 80 or 90 oil to coat 'O'-Rings and chain parts.

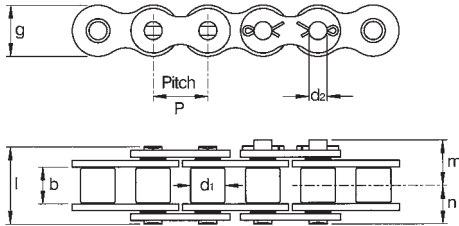

Cat. No.	Pitch P inches	Inside Width b min. mm	Roller Ø d: max. mm	Pin Ø d: max. mm	Plate Depth g mm	Rivet Pin Length l max. mm	Length to Cotter Pin m mm	Length to Rivet Pin n mm	Tensile Strength N	Weight Approx. kg/m
40-OR	1/2	7.85	7.95	3.96	11.8	18.00	20.60	9.00	14,600	0.66
50-OR	5/8	9.40	10.16	5.08	15.0	22.60	12.83	11.30	24,000	1.09
60-OR	3/4	12.60	11.91	5.94	18.0	28.70	16.38	14.35	34,250	1.55
80-OR	1	15.80	15.88	7.92	24.0	35.80	20.45	17.90	60,050	2.62
100-OR	1 1/4	19.00	19.05	9.53	30.0	44.20	24.38	22.10	97850	3.95

Sigma Sintered Bush Chain

Sigma Sintered Bush Chain combines the physical strength of ANSI Roller Chains with the self lubricating properties of special oil impregnated sintered metal bushes, to assure long reliable chain service where external lubrication is prohibited or extremely difficult to apply. The bush is precision formed from sintered steel, and impregnated with special lubricants. The oversize bush is press fitted into the inner link side-plates and protected by thin walled high performance roller.

Chain movement releases the oil to all bearing surfaces of bush, pin, plates and roller, minimising wear and power loss. The drive comes to rest, the lubricant is re-absorbed into the bush. Chain life extended by larger bearing areas.

Sigma SB Chain should not be used in temperatures above 100°C or at chain speeds over 5m/sec.

Sintered Bush Chain has increased breaking strength and fatigue strength compared to standard ANSI Chains.

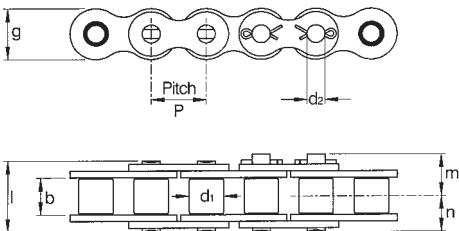

Cat. No.	Pitch P inches	Inside Width b min. mm	Roller Ø d: max. mm	Pin Ø d: max. mm	Plate Depth g mm	Rivet Pin Length l max. mm	Length to Cotter Pin m mm	Length to Rivet Pin n mm	Tensile Strength N	Weight Approx. kg/m
SG50	5/8	9.40	10.16	6.00	15.0	21.6	12.0	10.8	33,000	1.03
SG60	3/4	12.60	11.91	6.65	18.0	26.6	17.5	13.3	45,000	1.50
SG80	1	15.80	15.88	8.52	24.0	33.8	19.9	16.9	79,500	2.55

Thermoplastic Chains

Thermoplastic Chains provide an ideal solution for light duty conveying and transmission applications operating in harsh environmental conditions, moisture or chemicals, such as photographic developing equipment.

Available in four materials, Nylatron, Delrin®, Polypropylene and Kynar® in chains to ANSI 25, 35 and 40 dimensions. These chains have simple connection (the outer links snap together), lightweight (less than 20% steel), low noise level, and natural lubricity. Dependant on material, excellent chemical resistance and non conductivity can be achieved, refer to table; and all chains are non magnetic.

A wide selection of attachments for conveying applications is also available.

A range of Nylatron sprockets to suit all pitches, with tooth sizes from 9 to 45 are available, although chains can be operated on standard steel or stainless steel sprockets. For further details on sprocket sizes and chain selection consult Cross+Morse technical sales.

Material Data	Nylatron	Delrin® Acetal	Polypropylene	Kynar® PVDF
Water Absorption % 24 hrs. 1/8 thk	0.8	0.25	0.01	0.05
Resistance: Effects of				
Weak Acids	resistant	resistant	very-very resistant	very resistant
Strong Acids	attacked	some	slowly	very resistant
Weak Alkalines	very-very resistant	resistant	very-very resistant	very resistant
Strong Alkalines	resistant	resistant	very resistant	attacked
Organic Solvents	resistant	resistant	resistant below 80°C	resistant to most

Catalogue' No.	Dimensions mm							*Working Load kgs				Tensile Strength N			
	Pitch Ins	W Roller Width	D Roller Dia.	C Pin Dia.	F Plate Thick.	L Width Over Pins.	H Inside Plate Height	Material 1)				Material 1)			
								N	D	PP	K	N	D	PP	K
ANSI 25 PC	1/4	3.2	3.3	2.7	1.0	9.1	6.4	3.2	3.6	1.4	2.7	220	209	98	186
ANSI 35 PC	3/8	4.8	5.1	3.6	1.9	13.8	8.9	6.8	7.7	3.6	5.9	453	453	222	364
ANSI 40 PC	1/2	7.9	7.9	4.0	2.2	18.4	11.7	9.1	10.0	4.5	7.2	578	583	298	471

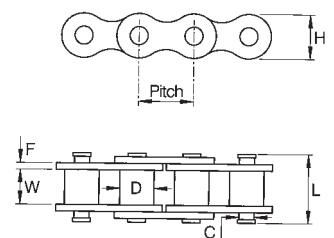

*Note: Values should only be used as a guideline. Application testing is strongly recommended. Use working loads for chain ratings. (I) N-Nylatron (GS) • D-Delrin (Acetal) • PP-Polypropylene • K-Kynar

†Total chain reference includes suffix for type of chain ie ANSI 25PC-D is Delrin.

®Delrin and Kynar are DuPont Trademarks

American Standard Double Pitch Roller Conveyor Chains



Conforming to ANSI B29.3 and B29.4

Double Pitch Roller Chains have twice the distance between rollers of corresponding standard roller chains. For example, ANSI No. 40 standard chain pitch is 1/2", ANSI No. 2040 chain pitch is 1". Since double pitch chains contain only half as many rollers, bushings and pins, they have lighter weight and greater economy than comparable standard chains. They are suited for applications with slow-to-moderate speeds, medium loads and long distances between sprockets, including a variety of conveyor systems and material handling equipment. ANSI transmission series chains feature figure-8 side plates and standard size rollers.

Transmission Series Chains to ANSI B29.3



Figure-8 contour of the transmission series side plates keeps chain weight to a minimum, and permits use of sprockets with maximum hub diameters. Link plate thickness, pins, bushes and rollers are same as corresponding standard roller chain.

ANSI No.	Pitch P inches	Inside Width b min. mm	Roller Ø d _r max mm	Pin Ø d _p max mm	Plate Depth g mm	Plate Thickness t mm	Rivet Pin Length l max mm	Length to Cotter Pin m mm	Length to Rivet Pin n mm	Bearing Area cm ²	Tensile Strength N	Weight Approx. kg/m
2040	1	7.85	7.95	3.96	11.8	1.52	16.6	10.7	8.3	0.44	14,800	0.45
2050	1 1/4	9.40	10.16	5.08	15.0	2.04	20.2	14.3	10.1	0.70	24,400	0.67
2060	1 1/2	12.60	11.91	5.94	18.0	2.38	25.0	16.3	12.5	1.06	34,000	1.02
2080	2	15.80	15.88	7.92	24.0	3.18	32.6	18.8	16.3	1.79	64,500	1.65
2100	2 1/2	19.00	19.05	9.53	30.0	3.96	39.2	23.2	19.6	2.62	100,000	2.89

Conveyor Series Chains to ANSI B29.4 - Standard and Large Diameter Rollers

Conveyor series chains with standard size rollers have straight side plates for increased bearing area when sliding on guides or supporting products. Large size rollers support the chain and load, holding them off the track to minimise friction and

power requirements. Chains 1 1/2" pitch or greater have side plates of same thickness as corresponding ANSI heavy series roller chains.

Standard Roller Series

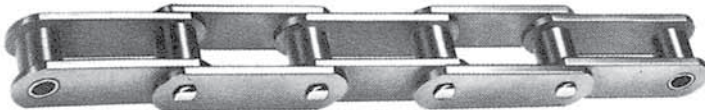

Large Roller Series

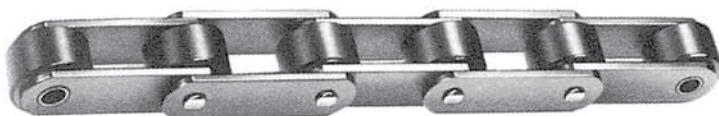

Thermoplastic Large Roller Series

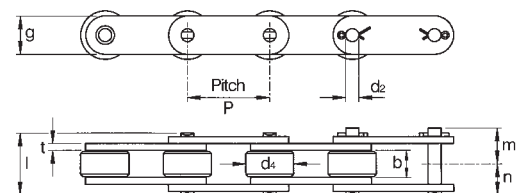
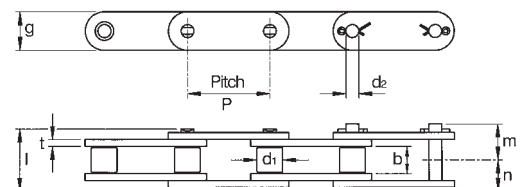
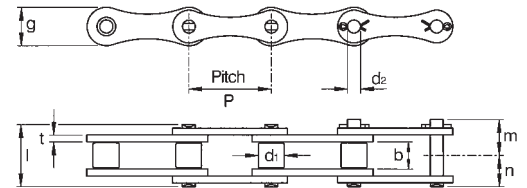
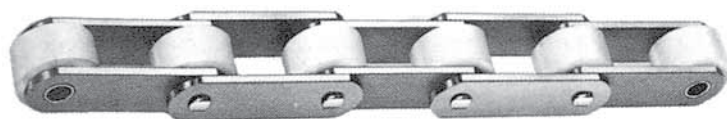

These chains are identical to large Roller Series except that the rollers are of thermoplastic material, reducing weight by approximately one third. Horsepower requirements are lower, and thermoplastic large rollers run quietly and smoothly; are tough and wear-resistant; require no lubrication and have improved resistance to corrosion. Chains with thermoplastic rollers are not recommended for operation below -17°C or above 80°C.

ANSI/CAT. Part No.			Pitch P inches	Inside Width b min.	Standard Roller dia. d _r max.	Large Roller dia. d _r max.	Side Plate		Pin dia. d _p max.	Rivet Pin Length l	Length to Conn Pin m	Length to Rivet Pin n	Tensile Strength N	Approx. Weight kg/m		
Standard Roller	Large Roller	Thermo-plastic					Height g	Thickness t						Standard Roller	Large Roller	Thermo-plastic
C2040	C2042	C2042D	1	7.85	7.95	15.88	11.7	1.52	3.96	16.6	10.7	8.3	14,800	0.48	0.82	0.49
C2050	C2052	C2052D	1 1/4	9.40	10.16	19.05	15.0	2.04	5.08	20.2	14.3	10.1	24,400	0.79	1.25	0.81
C2060H	C2062H	C2062D	1 1/2	12.60	11.91	22.23	17.6	3.18	5.94	28.3	16.6	14.1	34,000	1.37	2.10	1.40
C2080H	C2082H	C2082D	2	15.80	15.88	28.58	22.4	3.96	7.92	35.9	20.4	17.9	64,500	2.26	3.29	2.27
C2100H	C2102H	-	2 1/2	19.00	19.05	39.70	29.2	4.75	9.53	42.5	24.9	21.2	100,000	3.42	5.58	-
C2120H	C2122H	-	3	25.25	22.23	44.45	34.8	5.54	11.10	52.7	30.8	26.3	130,000	5.50	8.50	-
C2160H	C2162H	-	4	31.55	28.58	57.15	47.5	7.14	14.27	66.1	38.7	33.1	227,000	8.70	13.30	-

All dimensions in mm except as indicated.

Tel +44(0) 121 360 0155

Fax +44(0) 121 325 1079

Email sales@crossmorse.com

American Standard Double Pitch Chain Attachments



Email sales@crossmorse.com

Attachments for Double Pitch Chains are available in three basic types; straight attachments for connecting components to the side of chain, bent attachments for mounting components over chain; and extended pins for supporting hollow tubes or for use as driving dogs. All attachments can be fitted to any series of base conveyor chains illustrated on page 23, and different types of attachments may be combined within one chain assembly

Straight Attachments - S1 & S2

Available with either one or two hole attachments for both pin link and roller link. The links can be assembled into the chain on one side only - type S1, or both sides - type S2

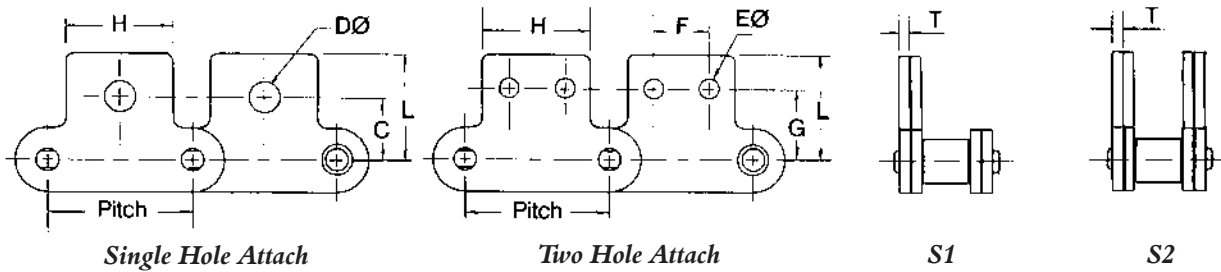

Standard Chain No.	Pitch P inches	Single Hole Attach		Two Hole Attach			Std. Attach. Length H	Attach. Height above Pin C.L. L	Plate Thickness T	Extra Weight Each Attach gms	
		C.L.Hole to C.L. Pin C	Hole Dia. D	Hole Dia. E	Hole Centres F	C.L.Hole to C.L. Pin G				S1	S2
		C	D	E	F	G				S1	S2
C2040	1	11.10	5.08	3.56	9.53	13.49	19.05	19.85	1.52	1.8	3.6
C2050	1 1/4	14.27	6.63	5.08	11.89	15.88	25.40	25.00	2.04	6.4	12.8
C2060H	1 1/2	17.48	8.20	5.08	14.27	19.05	28.58	30.00	3.18	15.9	31.8
C2080H	2	22.23	9.80	6.63	19.05	25.40	38.10	40.00	3.96	33.6	67.2
C2100H	2 1/2	28.58	13.11	8.20	23.83	31.75	47.63	50.40	4.75	60.0	120.0
C2120H	3	33.32	14.68	9.80	28.58	37.29	57.12	59.50	5.54	98.0	196.0

Fax +44(0) 121 325 1079

Bent attachments - B1 & B2

Available with either one or two attachment holes as single tab standard width attachments available for both pin and roller links. Attachments can be assembled into chain on one side only - type B1, or both sides - type B2, at any pitch spacing to suit the application, and can be combined with 'S' attachments if required.

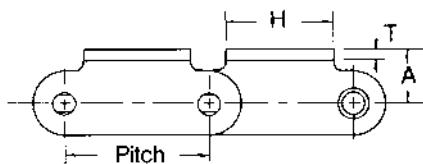
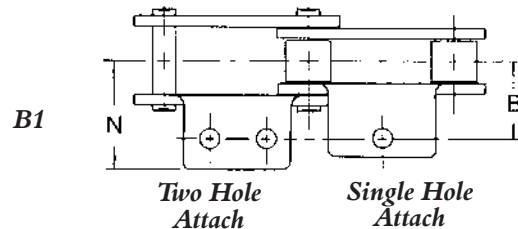

Standard Chain No.	Pitch P inches	Platform Height	Hole C.L. to Chain C.L.	Hole Dia.	Hole Centres	Attach. Length	Attach End to Chain C.L.	Plate Thickness	Extra Weight Each Attach gms	
		A	B	E	F	H	N	T	B1	B2
C2040	1	9.12	12.70	3.56	9.53	19.05	19.45	1.52	1.8	3.6
C2050	1 1/4	11.10	15.88	5.08	11.89	25.40	25.00	2.04	6.4	12.8
C2060H	1 1/2	14.68	21.44	5.08	14.27	28.58	30.55	3.18	15.9	31.8
C2080H	2	19.05	27.76	6.63	19.05	38.10	39.70	3.96	33.6	67.2
C2100H	2 1/2	23.42	33.32	8.20	23.83	47.63	50.00	4.75	60.0	120.0
C2120H	3	27.76	39.67	9.80	28.58	57.15	60.30	5.54	98.0	196.0

All dimensions in mm

Tel +44(0) 121 360 0155

American Standard Double Pitch Chains with Modified Pins



Tel +44(0) 121 360 0155 Fax +44(0) 121 325 1079 Email sales@crossmorse.com

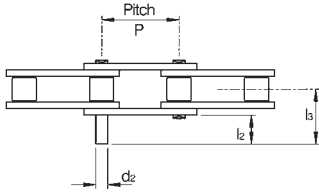

D-1 Single Pin One Side

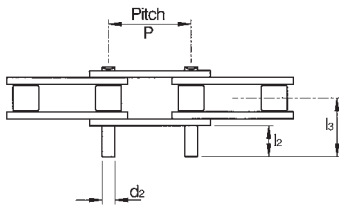

D-3 Double Pin One Side

Extended Pin Chains - D Attachment

All standard conveyor chains can be supplied with rivet pin extended one side only. Either or both pins on a outer link can be extended, the spacing of extended pins within the chain assembly varied to suit application. These attachments may be combined with other attachments within one chain assembly.

Standard Chain No.	Pitch P inches	Pin Dia. d ₂ max.	Pin Projection l ₂	End of Pin to C.L. Chain l ₃
C2040	1	3.96	9.52	16.66
C2050	1 1/4	5.08	11.89	21.03
C2060H	1 1/2	5.94	14.28	26.97
C2080H	2	7.92	19.05	34.93
C2100H	2 1/2	9.53	23.80	42.85
C2120H	3	11.10	28.57	52.37

Hollow Pin Chains - Rollerless and with Large Rollers

Hollow pin conveyor chains are used to support rods to carry wire mesh etc. The standard chain is of bush construction with bush diameter equal to the diameter of standard solid pin chain. Also available is chain fitted with conventional large diameter rollers. Note: These chains cannot be combined with other attachment.

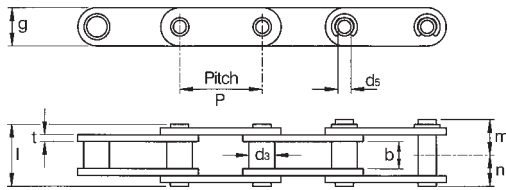

Double Pitch Rollerless Hollow Pin Chain

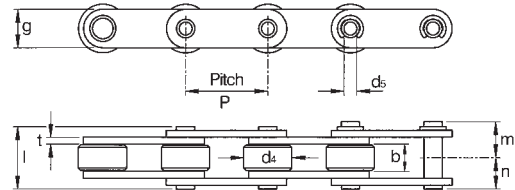

Double Pitch Large Diameter Roller Hollow Pin Chain

Cat. No.		Pitch P Inches	Inside Width b min.	Bush Diameter d ₃	Large Roller Diameter d ₄ max.	Pin Bore d ₅ min.	Sideplate		Rivet Pin Length l	Length to Conn. Pin m	Length to Rivet Pin n	Tensile Strength N	Approx. Weight kg/m	
Bush Chain	Large Roller Chain						Height g	Thickness t					Bush Chain	Large Roller Chain
C2040HP	C2042HP	1	7.85	7.92	15.88	4.01	11.7	1.52	16.6	9.4	8.3	10,000	0.46	0.80
C2050HP	C2052HP	1 1/4	9.40	10.16	19.05	5.15	15.0	2.04	20.2	11.7	10.1	14,800	0.76	1.25
C2060HP	C2062HP	1 1/2	12.60	11.91	22.23	6.02	17.6	2.39	24.7	14.5	12.4	24,400	1.12	1.79
C2080HP	C2082HP	2	15.80	15.88	28.58	8.07	22.4	3.18	31.0	17.8	15.5	34,000	1.98	3.17

Double Pitch Stainless Steel Chains



Email sales@crossmorse.com
 Fax +44(0) 121 325 1079
 Tel +44(0) 121 360 0155

Stainless Steel Chains

Available in standard base chain with standard or large rollers, or chain with thermoplastic large rollers. Sideplate manufactured from 18-8 stainless steel with round parts using 17-7PH or 17-4PH materials, S and B attachments are available in 18-8 material, also D1 and D3 extended pins can be provided to special order. The thermoplastic stainless chains, suffix DS, can be operated without lubrication, and provide quiet operation with high corrosion resistance. DS chains can only be used in applications within operating temperature range -17°C to 80°C.

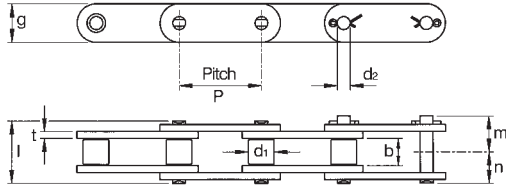

Standard Roller Series

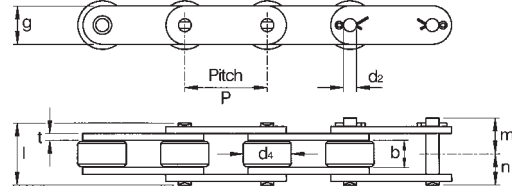

Large Roller and Thermoplastic Series

ANSI/Cat. Part No.			Pitch P Inches	Inside Width b min.	Standard Roller Dia. d: max.	Large Roller Diameter d: max.	Sideplate		Pin Bore d: min.	Rivet Pin Length l	Length to Conn. Pin m	Length to Rivet Pin n	Tensile Strength N	Approx. Weight kg/m		
Standard Roller	Large Roller	Thermo-plastic					Height g	Thickness t						Standard Roller	Large Roller	Thermo-plastic
C2040SS	C2042SS	C2042DSS	1	7.85	7.95	15.88	11.7	1.52	3.96	16.6	10.7	8.3	12,000	0.55	0.89	0.57
C2050SS	C2052SS	C2052DSS	1/4	9.40	10.16	19.05	15.0	2.04	5.08	20.2	14.3	10.2	18,800	0.91	1.37	0.92
C2060SS	C2062SS	C2062DSS	1/2	12.60	11.91	22.23	17.6	2.39	5.94	24.9	16.3	12.5	27,000	1.07	1.80	1.10
C2080SS	C2082SS	C2082DSS	2	15.80	15.88	28.58	22.4	3.18	7.92	32.5	18.8	16.3	48,000	1.46	2.49	1.46
C2100SS	C2102SS	-	2 1/2	19.00	19.05	39.70	29.2	4.75	9.53	42.5	24.9	21.2	100,000	3.42	5.58	-
C2120SS	C2122SS	-	3	25.25	22.23	44.45	34.8	5.54	11.10	52.7	30.8	26.3	130,000	5.50	8.50	-

All dimensions in mm except as indicated.

Triple Speed Conveyor Chain

Triple Speed Conveyor Chain, often referred to as "Accumulator Chain", provides a means of rapid transfer of product combined with the facility to accumulate production in the event of a line overload. The chain is frequently used in the production lines of domestic electronic products, such as televisions, computers, and HiFi equipment. Carriers containing the products being assembled are supported on the large rollers of two or more chains, whilst the chains themselves are supported on the smaller rollers. As the chain is driven forwards frictional drive between the rollers causes the product carrier to be transferred forward at up to 2.6 times the chain speed. If there is an hold-up of product on the line the large carrier rollers are able to slip within the chain, thereby allowing the product carriers to remain static. The speed increasing function of the chain allows the chain to run at slower speeds thereby reducing noise levels and running costs. Chain can be supplied with rollers manufactured in either a conductive plastic material, or alternately a non conductive plastic where insulation is required.

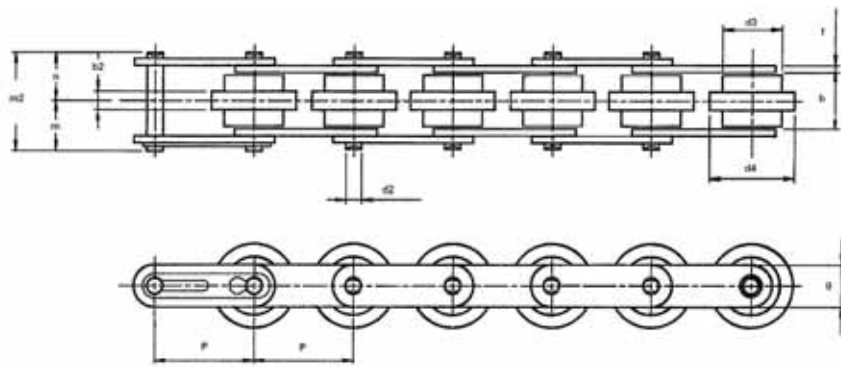

Chain Technical Specifications

Chain No.	Pitch P mm	Roller Material	Allowable Chain Pull N	Max Loading kg	Tensile Strength KN	Speed Ratio	Weight Approx kg/m
C2040TS Cond	25.40	Conductive Plastic	1000	17	14	2.56	0.7
C2040TS Non	25.40	Non Conductive Plastic	1000	17	14	2.56	0.7
C2050TS Cond	31.75	Conductable Plastic	1500	25	23	2.58	1.1
C2050TS Non	31.75	Non Conductive Plastic	1500	25	23	2.58	1.1
C2060TS Cond	38.10	Conductable Plastic	2250	39	32	2.60	2.2
C2060TS Non	38.10	Non Conductive Plastic	2250	39	32	2.60	2.2

Chain Dimension in mm

Chain Ref	Inside Width b	Large Roller Width b2	Pin dia d2	Small Roller dia d3	Large Roller dia d4	Plate Depth g	m	Pin Lengths n	m2	Plate thickness t
C2040TS	22.43	8.94	3.96	15.85	24.61	11.68	16.28	15.24	31.52	1.52
C2050TS	27.81	11.30	5.08	19.05	30.15	15.00	20.83	19.05	39.88	2.03
C2060TS	31.55	14.94	5.94	22.23	35.74	17.53	25.91	23.62	49.53	3.18

Note: Dimensions are applicable to both Conductive and Non Conductive types

Food Processing – Attachment Chain



A range of high-performance power transmission chain has been developed by Cross + Morse to cope with the demands of the food processing industries.

In-Feed Chains

Working with leading manufacturers of food packaging and processing machinery, the Cross + Morse chain system is developed to provide unfailing operation throughout lengthy production cycles, 24 hours a day. Suitable for new or retrofit installation, the in-feed chain system is designed to incorporate attachments, custom-manufactured by Cross + Morse, to transport the product through continuous application processes without operator interaction.

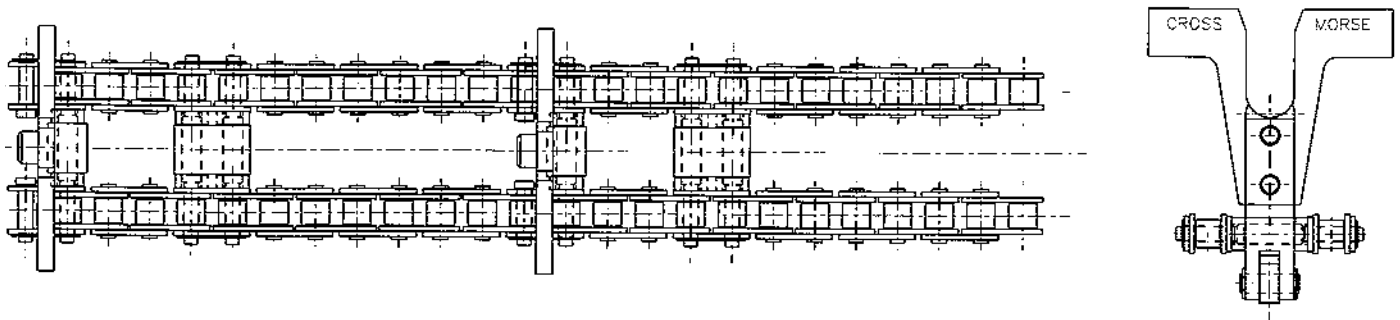

Cross Feed Chains

With its in house machining capability Cross + Morse are able to manufacture pins to suit most requirements. An example of this is the Cross Feed chains with a 7mm dia x 20mm pin every pitch seen below.

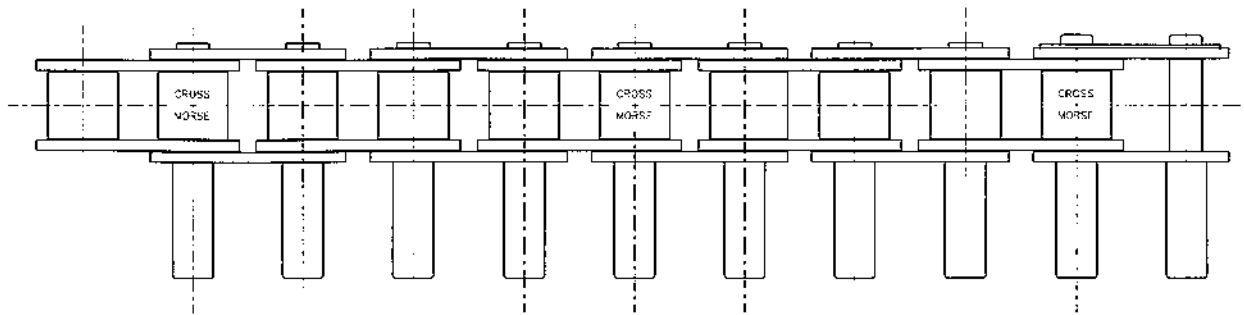

Powerbend Chains

Cross + Morse work with the leading food producers to solve their processing problems, one project resulted in our engineers creating a chain with a bearing and a specially designed pin attached to enable the conveying of product through 180°C.

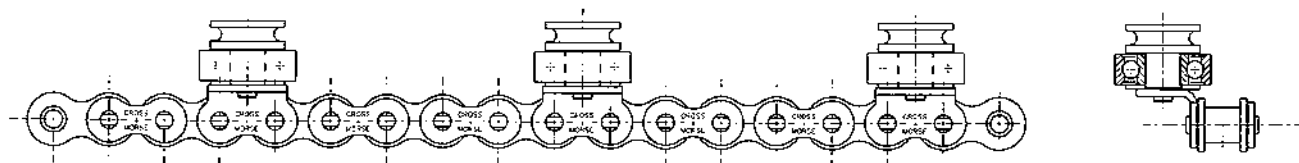

Chocolate Moulding Plant Chains

Attachments and chains for Chocolate Moulding plants are notoriously difficult to replace especially the pin conveying the trays but Cross + Morse have the experience and knowledge to overcome any such problems. We have retro-fitted our chains to a number of machines of different manufacture with outstanding reductions in downtime and extended chainlife.

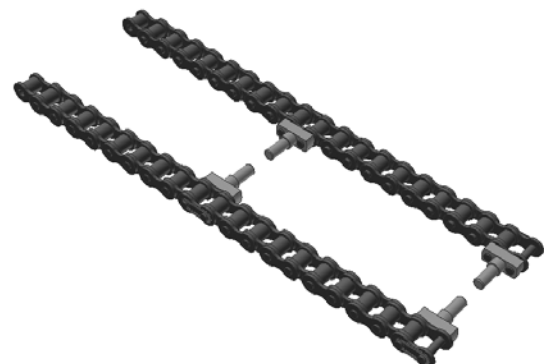

Tel +44(0) 121 360 0155

Fax +44(0) 121 325 1079

Email sales@crossmorse.com

Cross+Morse Machine Shop Manufacturing System



In addition to our comprehensive range of Standard Sprockets and Platewheels to suit British and American Standard Chains, the modern machine shop facilities at Birmingham enable quick, cost effective production of custom designed sprocket assemblies and platewheels to suit most chain drive applications.

Special pulleys for all forms of Timing Belt Drives can be provided including tandem pulleys, units complete with freewheel and teeth cut direct onto shafting.

Specially manufactured gears to customers drawings include straight cut Mitre and Bevel gears up to 250mm diameter. Spur gears up to 1600mm diameter, and Helical gears up to 710mm diameter can be provided with either DP or Module tooth forms. Internal gears, splines and serrations can also be cut.

Straight Racks up to 2 metres individual length can be provided in a variety of materials with either DP or Module tooth forms, and for large drives segment gears can be machined.

Shafting up to 1 metre length can be supplied complete with required splines, keyseats or locking threads. Package drive systems combining the above products, or with enclosed cases, can be designed and manufactured in co-operation with our customers.

General Machining and Turning Department

Programmed Saws can provide blanks up to 420mm dia for turning, larger sizes or castings being sub-contracted from approved suppliers. CNC lathes with Power Tooling enable efficient low cost production of complex blanks including finished milled slots and drilled and tapped holes. Blanks up to 460mm dia, and 1 metre length can be handled, with bar feed facilities up to 65mm dia. The CNC lathes are supported by a selection of standard centre lathes, capstan lathes and vertical lathes up to 1500mm dia.

The department also includes Pillar and Radial Drills enabling quick production of setscrews and drilling for taper bore sprockets; and Universal Milling Machines.

Fine finishes and close tolerances of both base and outside diameters are achieved within the grinding area for diameters up to 300mm, and platewheels for Torque Limiters are face ground on Lumsden Grinder.



Gear Cutting Department

Our gear cutting facilities include a large number of Gear Shapers, mainly used for sprocket production up to 400mm dia, Gear Hobbers for gear and inverted tooth sprocket production up to 900mm dia, and a Sunderland Gear Planer for production all products up to 1500mm dia. Bevel Generators can provide mitres and bevels up to 250mm dia. A wide selection of tooling enables production of most forms of chain sprockets, timing belt pulleys and gears.

Although it is preferred to manufacture sprockets, pulleys or gears complete to ensure total quality control; capacity is available to cut teeth only on customers finished blanks.

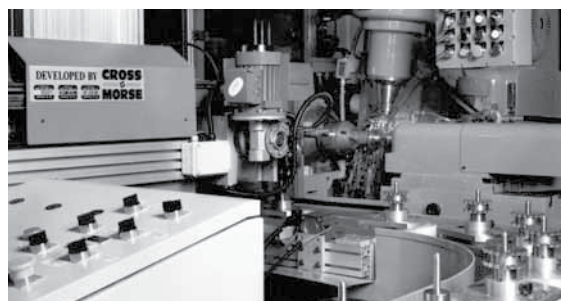

Broaching and Keyseating

A number of horizontal broaching machines can handle work up to 3 metres diameter, with a wide selection of forms available from our stock of more than 1000 broaches including:-

Involute Tooth Splines from 22-76mm Outside Diameter.

Straight sided Serrations from 20-55mm Outside Diameter.

1 to 12 tooth straight sided splines from 7-57mm Outside Diameter.

Square Bores (Imperial) from 0.28-1.25 inches square.

Plus broaches for 'D' holes, holes with flats, hexagons, rectangles and inverted key holes.

All standard sizes of keyseats can be broached, and specials produced on vertical slotter.



Additional Facilities

Other production facilities which are used in the production of gearing products include:-

Induction Hardening for gears up to 450mm diameter and maximum 150mm thickness, ensures fast accurate hardening for both customised products and standard sprockets and gears.

Cold Chemical Blacking Plant used for finishing of standard sprockets to provide corrosion protection and good appearance, is available for all customised product if specified, and hot phosphate plant for timing pulleys and gears.

Both electric and Mig Co² Welding facilities for production of larger sprockets and gears up to 150mm diameter.

**For all your sprocket, pulley and gear requirements
contact Cross+Morse Engineering Sales for advice and price.**

Custom Design Sprockets and Platewheels



Special sprockets and platewheels can be manufactured to customers specifications on short lead times. In addition to conventional designs, double bossed sprockets, split wheels, ring gears and segments can be provided, to suit B.S. and ANSI roller, bush and extended pitch chains of simplex or multistrand construction; Inverted Tooth Chains; and many special pitch and conveyor chains from 4mm to 3" pitch. Complete manufacture is possible from a wide range of materials, with finishes applied as required. Cast Iron wheels and fabricated assemblies can be provided, and a 'tooth cut only' service on customer's finished blanks. Also standard sprockets and platewheels can be customised to suit specific applications by modifying dimensions, reworking the bore, or welding to adaptors etc. Sprockets and platewheels can be supplied combined with other Cross+Morse transmission products such as freewheel clutches and overload protection devices.



Custom design sprockets should conform to the following dimensions:-

Sprocket Pitch Circle Diameter = $P/\sin(180/N)$
 Approx. Outside Diameter = $P[0.5 + \text{Cot}(180/N)]$
 Maximum Hub Diameter = $P[\text{Cot}(180/N) - 1] - 0.8$

Where:- N = No. Sprocket Teeth P = Chain Pitch mm

Roller Chain Sprocket Tooth Data British Standard Chains

Simplex

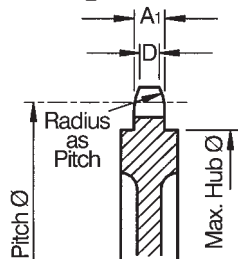

Duplex

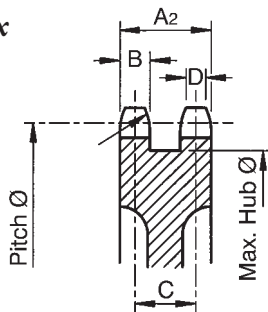

Triplex

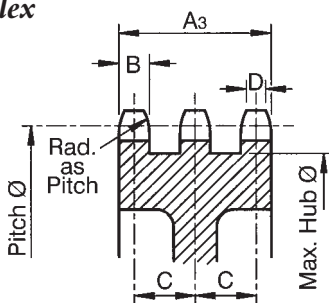

Double Simplex Sprockets

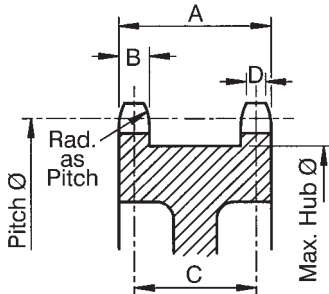

Chain Size	Pitch (in)	A ₁ max.	A ₂ max.	A ₃ max.	B max.	C	D
04B	.236	2.6	-	-	-	-	1.2
05B	.315	2.8	8.3	-	2.7	5.6	1.2
06B	.375	5.3	15.4	25.6	5.2	10.2	3.3
081	.500	3.0	-	-	-	-	0.4
083/084	.500	4.5	-	-	-	-	1.9
08B	.500	7.2	21.0	35.0	7.0	13.9	4.6
10B	.625	9.1	25.6	42.2	9.0	16.6	5.9
12B	.750	11.1	30.3	49.8	10.9	19.5	7.1
16B	1.000	16.1	47.7	79.5	15.8	31.8	11.0
20B	1.250	18.5	54.6	91.1	18.2	36.4	11.5
24B	1.500	24.1	72.0	120.3	23.6	48.4	16.1
28B	1.750	29.4	88.4	148.0	28.8	59.6	19.4
32B	2.000	29.4	87.4	146.0	28.8	58.5	19.4
40B	2.500	36.2	107.7	180.0	35.4	72.3	21.7

American Standard Chains

Chain Size	Pitch (in)	A ₁ max.	A ₂ max.	A ₃ max.	B max.	C	D
25	.250	2.9	9.1	15.5	2.8	6.4	1.5
35	.375	4.3	14.2	24.4	4.2	10.1	1.9
40	.500	7.3	21.4	35.7	7.1	14.4	4.2
41	.500	5.9	-	-	-	-	3.1
50	.625	8.9	26.8	44.9	8.7	18.1	5.8
60	.75	11.9	34.4	57.1	11.7	22.7	7.6
80	1.00	14.9	43.9	73.2	14.6	29.3	9.8
100	1.25	17.9	53.3	89.0	17.5	35.8	11.2
120	1.50	23.9	68.8	114.2	23.4	45.4	15.8
140	1.75	23.9	72.2	121.1	23.4	48.9	13.6
160	2.00	29.9	87.8	146.4	29.3	58.5	19.2
200	2.50	35.9	106.7	178.3	35.2	71.5	21.6

British Standard Chains

Chain Size	A	B max.	D
05B	19.0	2.7	1.2
06B	23.5	5.3	3.3
08B	31.0	7.2	4.6
10B	36.5	9.1	5.9
12B	45.0	11.1	7.1
16B	63.5	16.1	11.0
20B	73.5	18.5	11.5
24B	94.0	24.1	16.1
32B	113.0	29.4	19.4

American Standard Chains

Chain Size	A	B max.	D
35	22.0	4.2	1.9
40	34.5	7.1	4.2
50	39.5	8.7	5.8
60	47.5	11.7	7.6
80	60.5	14.6	9.8
100	74.0	17.5	11.2
120	93.0	23.4	15.8
140	97.0	23.4	13.6
160	115.5	29.3	19.2

Tel +44(0) 121 360 0155

Fax +44(0) 121 325 1079

Email sales@crossmorse.com

Taper Bore Sprockets for $3/8''$ Pitch British Standard Chains Type 06B

Conforming to ISO Std 606

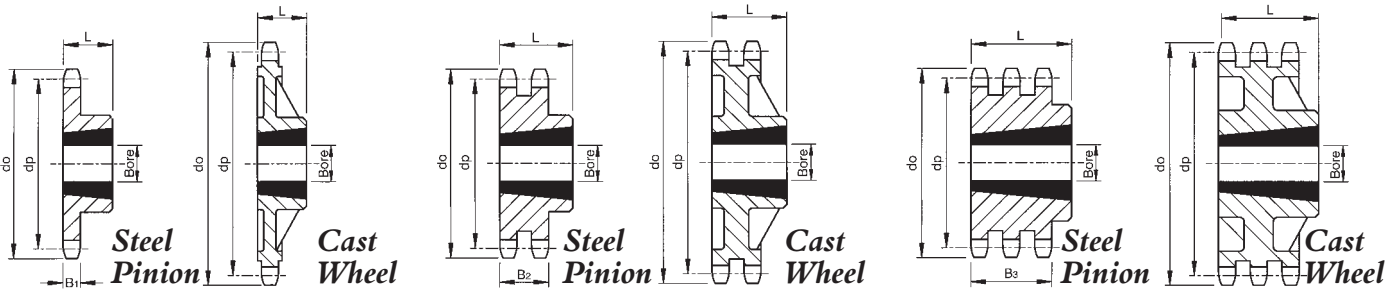

Simplex Sprockets Chain No. 06B-1

Duplex Sprockets Chain No. 06B-2

Triplex Sprockets Chain No. 06B-3

Cat. No.	No. Teeth	Pitch Circle Ø dp	Outside Ø do	Taper Bore Bush			Length L	Approx. Weight kg
				Bush No.	Min. Bore	Max. Bore		

Simplex Chain No. 06B-1 - Tooth Width B_1 - 5.3mm

TB06B1-17	17	51.83	55.3	1008	9	25	22	0.13
TB06B1-18	18	54.85	58.3	1008	9	25	22	0.15
TB06B1-19	19	57.87	61.3	1008	9	25	22	0.17
TB06B1-20	20	60.89	64.3	1008	9	25	22	0.19
TB06B1-21	21	63.91	68.0	1008	9	25	22	0.20
TB06B1-22	22	66.93	71.0	1108	9	28	22	0.20
TB06B1-23	23	69.95	73.5	1210	11	32	25	0.32
TB06B1-24	24	72.97	77.0	1210	11	32	25	0.33
TB06B1-25	25	76.00	80.0	1210	11	32	25	0.35
TB06B1-26	26	79.02	83.0	1210	11	32	25	0.37
TB06B1-27	27	82.05	86.0	1210	11	32	25	0.39
TB06B1-28	28	85.07	89.0	1210	11	32	25	0.41
TB06B1-30	30	91.12	94.7	1210	11	32	25	0.44
TB06B1-38	38	115.35	119.5	1210	11	32	25	0.85
TB06B1-45	45	136.55	140.7	1210	11	32	25	1.15
TB06B1-57	57	172.91	176.9	1210	11	32	25	1.20
TB06B1-76	76	230.49	234.9	1210	11	32	25	1.88
Cast Iron Wheels								
TB06B1-57	57	172.91	177.0	1210	11	32	25	1.5
TB06B1-76	76	230.49	234.9	1210	11	32	25	2.0
TB06B1-95	95	288.08	292.5	1210	11	32	25	3.2
TB06B1-114	114	345.68	349.5	1215	11	32	38	4.0

Duplex Chain No. 06B-2 - Tooth Width B_2 - 15.4mm

TB06B2-17	17	51.83	55.3	1008	9	25	22	0.15
TB06B2-18	18	54.85	58.3	1008	9	25	22	0.17
TB06B2-19	19	57.87	61.3	1008	9	25	22	0.19
TB06B2-20	20	60.89	64.3	1008	9	25	22	0.22
TB06B2-21	21	63.91	68.0	1008	9	25	22	0.25
TB06B2-22	22	66.93	71.0	1108	9	28	22	0.25
TB06B2-23	23	69.95	73.5	1210	11	32	25	0.27
TB06B2-24	24	72.97	77.0	1210	11	32	25	0.34
TB06B2-25	25	76.00	80.0	1210	11	32	25	0.39
TB06B2-26	26	79.02	83.0	1210	11	32	25	0.43
TB06B2-27	27	82.05	86.0	1210	11	32	25	0.47
TB06B2-28	28	85.07	89.0	1210	11	32	25	0.52
TB06B2-30	30	91.12	94.7	1210	11	32	25	0.61
TB06B2-38	38	115.35	119.5	1610	14	42	25	1.00
TB06B2-45	45	136.55	140.7	1610	14	42	25	1.76
TB06B2-57	57	172.91	176.9	1610	14	42	25	2.51
TB06B2-76	76	230.49	234.9	1610	14	42	25	4.55
Cast Iron Wheels								
TB06B2-57	57	172.91	177.0	1610	14	42	25	1.8
TB06B2-76	76	230.49	234.9	1610	14	42	25	2.3
TB06B2-95	95	288.08	292.5	1610	14	42	25	4.6
TB06B2-114	114	345.68	349.5	1615	14	42	38	5.3

Triplex Chain No. 06B-3 - Tooth Width B_3 - 25.6mm

TB06B3-17	17	51.83	55.3	1008	9	25	26	0.20
TB06B3-19	19	57.87	61.3	1008	9	25	26	0.25
TB06B3-21	21	63.91	68.0	1008	9	25	26	0.35
TB06B3-23	23	69.95	73.5	1210	11	32	26	0.25
TB06B3-25	25	76.00	80.0	1210	11	32	26	0.30
TB06B3-30	30	91.12	94.7	1615	14	42	38	1.50
TB06B3-38	38	115.35	119.5	1615	14	42	38	1.50
Cast Iron Wheels								
TB06B3-57	57	172.91	177.0	1615	14	42	38	3.0
TB06B3-76	76	230.49	234.9	1615	14	42	38	3.5

All dimensions in mm. Details Taper Bore Bushes refer pp 38/39.

Additional Facilities

All Steel Taper Bore Sprockets are suitable for Induction Hardening of teeth. Sprockets with teeth hardened to 45 Rc can be supplied on 48-hours lead time.

Taper Bore Sprockets for 1/2" Pitch British Standard Chains Type 08B

Conforming to ISO Std 606

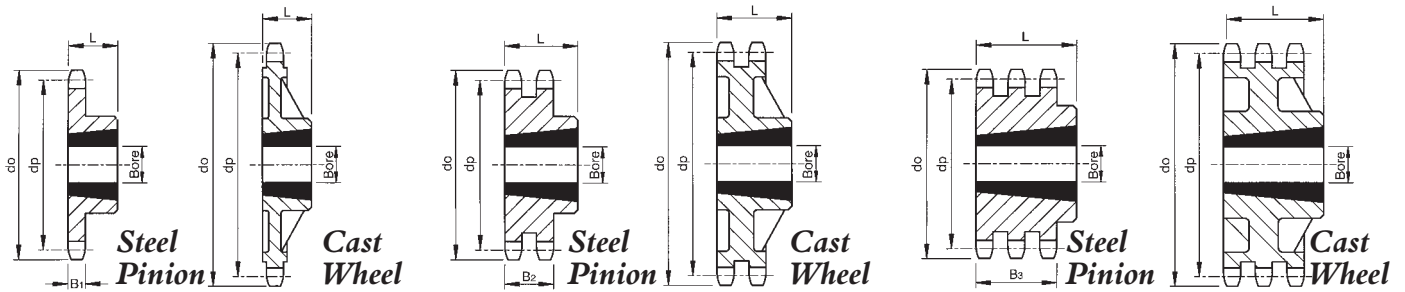

Simplex Sprockets
Chain No. 08B-1

Duplex Sprockets
Chain No. 08B-2

Triplex Sprockets
Chain No. 08B-3

Cat. No.	No. Teeth	Pitch Circle Ø dp	Outside Ø do	Taper Bore Bush			Length L	Approx. Weight kg
				Bush No.	Min. Bore	Max. Bore		

Simplex Chain No. 08B-1 - Tooth Width B₁ - 7.2mm

TB08B1-15	15	61.09	65.5	1008	9	25	22	0.21
TB08B1-16	16	65.10	69.5	1108	9	28	22	0.23
TB08B1-17	17	69.11	73.6	1210	11	32	25	0.24
TB08B1-18	18	73.14	77.8	1210	11	32	25	0.29
TB08B1-19	19	77.16	81.7	1210	11	32	25	0.35
TB08B1-20	20	81.19	85.8	1610	14	42	25	0.40
TB08B1-21	21	85.22	89.7	1610	14	42	25	0.40
TB08B1-22	22	89.24	93.8	1610	14	42	25	0.50
TB08B1-23	23	93.27	98.2	1610	14	42	25	0.54
TB08B1-24	24	97.29	101.8	1610	14	42	25	0.57
TB08B1-25	25	101.33	105.8	1610	14	42	25	0.61
TB08B1-26	26	105.36	110.0	1610	14	42	25	0.65
TB08B1-27	27	109.40	114.0	1610	14	42	25	0.69
TB08B1-28	28	113.42	118.0	2012	14	50	32	0.95
TB08B1-30	30	121.50	126.1	2012	14	50	32	1.00
TB08B1-38	38	153.80	158.6	2012	14	50	32	1.68
TB08B1-45	45	182.07	188.0	2012	14	50	32	2.07
TB08B1-57	57	230.54	236.4	2012	14	50	32	2.70
Cast Iron Wheels								
TB08B1-57	57	230.54	235.7	2012	14	50	32	2.5
TB08B1-76	76	307.33	312.4	2012	14	50	32	3.7
TB08B1-95	95	384.11	389.4	2012	14	50	32	5.1
TB08B1-114	114	460.90	466.9	2517	19	65	45	7.1

Duplex Chain No. 08B-2 - Tooth Width B₂ - 21.0mm

TB08B2-15	15	61.09	65.5	1008	9	25	22	0.21
TB08B2-16	16	65.10	69.5	1108	9	28	22	0.25
TB08B2-17	17	69.11	73.6	1210	11	32	25	0.29
TB08B2-18	18	73.14	77.8	1210	11	32	25	0.35
TB08B2-19	19	77.16	81.7	1210	11	32	25	0.41
TB08B2-20	20	81.19	85.8	1610	14	42	25	0.37
TB08B2-21	21	85.22	89.7	1610	14	42	25	0.43
TB08B2-22	22	89.24	93.8	1610	14	42	25	0.51
TB08B2-23	23	93.27	98.2	1610	14	42	25	0.56
TB08B2-24	24	97.29	101.8	1610	14	42	25	0.65
TB08B2-25	25	101.33	105.8	2012	14	50	32	0.75
TB08B2-26	26	105.36	110.0	2012	14	50	32	0.85
TB08B2-27	27	109.40	114.0	2012	14	50	32	0.95
TB08B2-28	28	113.42	118.0	2012	14	50	32	1.05
TB08B2-30	30	121.50	126.1	2012	14	50	32	1.29
TB08B2-38	38	153.80	158.6	2012	14	50	32	2.57
TB08B2-45	45	182.07	188.0	2012	14	50	32	3.36
Cast Iron Wheels								
TB08B2-57	57	230.54	235.7	2012	14	50	32	3.3
TB08B2-76	76	307.33	312.4	2012	14	50	32	4.9
TB08B2-95	95	384.11	389.4	2012	14	50	32	7.5
TB08B2-114	114	460.90	466.9	2517	19	65	45	9.5

Triplex Chain No. 08B-3 - Tooth Width B₃ - 34.9mm

TB08B3-15	15	61.09	65.5	1008	9	25	35	0.42
TB08B3-17	17	69.11	73.6	1210	11	32	35	0.55
TB08B3-19	19	77.16	81.7	1210	11	32	35	0.75
TB08B3-21	21	85.22	89.7	1610	14	42	35	0.90
TB08B3-23	23	93.27	98.2	1610	14	42	35	1.13
TB08B3-25	25	101.33	105.8	2012	14	50	35	1.45
TB08B3-27	27	109.40	114.0	2012	14	50	35	1.80
TB08B3-30	30	121.50	126.1	2012	14	50	35	2.40
TB08B3-38	38	153.80	158.6	2012	14	50	35	4.87

All dimensions in mm. Details Taper Bore Bushes refer pp 38/39.

Additional Facilities

All Steel Taper Bore Sprockets are suitable for Induction Hardening of teeth. Sprockets with teeth hardened to 45 Rc can be supplied on 48-hours lead time.

Tel +44(0) 121 360 0155

Fax +44(0) 121 325 1079

Email sales@crossmorse.com

Taper Bore Sprockets for $5/8''$ Pitch British Standard Chains Type 10B

Conforming to ISO Std 606

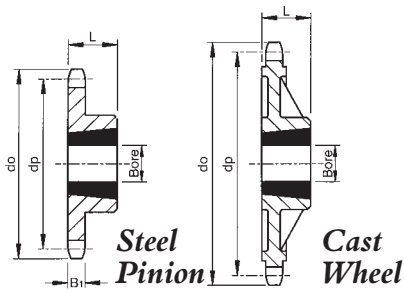

Simplex Sprockets
Chain No. 10B-1

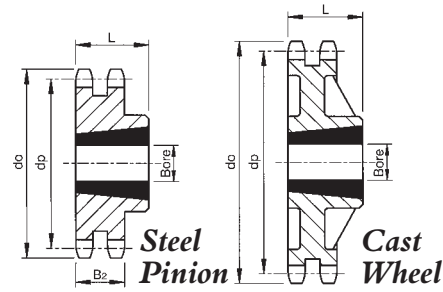

Duplex Sprockets
Chain No. 10B-2

Cat. No.	No. Teeth	Pitch Circle Ø dp	Outside Ø do	Taper Bore Bush			Length L	Approx. Weight kg
				Bush No.	Min. Bore	Max. Bore		

Simplex Chain No. 10B-1 - Tooth Width B₁ -

TB10B1-13	13	66.32	73.0	1008	9	25	22	0.27
TB10B1-14	14	71.34	78.0	1108	9	28	22	0.28
TB10B1-15	15	76.36	83.0	1210	11	32	25	0.38
TB10B1-16	16	81.37	88.0	1610	14	42	25	0.37
TB10B1-17	17	86.39	93.0	1610	14	42	25	0.44
TB10B1-18	18	91.42	98.3	1610	14	42	25	0.52
TB10B1-19	19	96.45	103.3	1610	14	42	25	0.61
TB10B1-20	20	101.49	108.4	1610	14	42	25	0.65
TB10B1-21	21	106.52	113.4	1610	14	42	25	0.72
TB10B1-22	22	111.55	118.0	1610	14	42	25	0.79
TB10B1-23	23	116.58	123.4	1610	14	42	25	0.85
TB10B1-24	24	121.62	128.3	1610	14	42	25	1.06
TB10B1-25	25	126.66	134.0	2012	14	50	32	1.14
TB10B1-26	26	131.70	139.0	2012	14	50	32	1.21
TB10B1-27	27	136.75	144.0	2012	14	50	32	1.28
TB10B1-28	28	141.78	148.7	2012	14	50	32	1.36
TB10B1-30	30	151.87	158.8	2012	14	50	32	1.54
TB10B1-38	38	192.24	199.2	2012	14	50	32	2.52
TB10B1-45	45	227.58	235.0	2012	14	50	32	3.20
TB10B1-57	57	288.18	296.0	2012	14	50	32	4.92

Cast Iron Wheels

TB10B1-57	57	288.18	296.0	2012	14	50	32	3.5
TB10B1-76	76	384.16	392.1	2012	14	50	32	5.4
TB10B1-95	95	480.14	488.5	2517	19	65	45	8.8
TB10B1-114	114	576.13	584.1	2517	19	65	45	14.0

Duplex Chain No. 10B-2 - Tooth Width B₂ - 25.6mm

TB10B2-15	15	76.36	83.0	1210	11	32	26	0.32
TB10B2-16	16	81.37	88.0	1610	14	42	26	0.32
TB10B2-17	17	86.38	93.0	1610	14	42	26	0.41
TB10B2-18	18	91.42	98.3	1610	14	42	26	0.50
TB10B2-19	19	96.45	103.3	1610	14	42	26	0.64
TB10B2-20	20	101.49	108.4	1610	14	42	26	0.78
TB10B2-21	21	106.52	113.4	1610	14	42	26	0.93
TB10B2-22	22	111.55	118.0	1610	14	42	26	1.08
TB10B2-23	23	116.58	123.4	1610	14	42	26	1.23
TB10B2-24	24	121.62	128.3	2012	14	50	32	1.30
TB10B2-25	25	126.66	134.0	2012	14	50	32	1.45
TB10B2-26	26	131.70	139.0	2012	14	50	32	1.60
TB10B2-27	27	136.75	144.0	2012	14	50	32	1.76
TB10B2-28	28	141.78	148.7	2012	14	50	32	1.94
TB10B2-30	30	151.87	158.8	2012	14	50	32	2.30
TB10B2-38	38	192.24	199.2	2517	19	65	45	4.85

All dimensions in mm. Details Taper Bore Bushes refer pp 38/39.

Additional Facilities

All Steel Taper Bore Sprockets are suitable for Induction Hardening of teeth. Sprockets with teeth hardened to 45 Rc can be supplied on 48-hours lead time.

Email sales@crossmorse.com Fax +44(0) 121 325 1079 Tel +44(0) 121 360 0155

Taper Bore Sprockets for $3/4''$ Pitch British Standard Chains Type 12B

Conforming to ISO Std 606

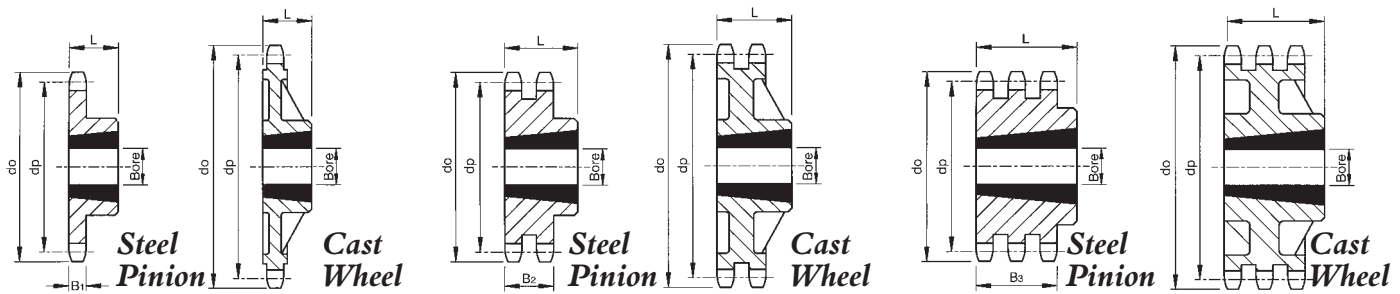

Simplex Sprockets

Chain No. 12B-1

Duplex Sprockets

Chain No. 12B-2

Triplex Sprockets

Chain No. 12B-3

Cat. No.	No. Teeth	Pitch Circle Ø dp	Outside Ø do	Taper Bore Bush			Length L	Approx. Weight kg
				Bush No.	Min. Bore	Max. Bore		

Simplex Chain No. 12B-1 - Tooth Width B_1 - 11.1mm

TB12B1-13	13	79.59	87.5	1210	11	32	25	0.44
TB12B1-14	14	85.61	93.6	1610	14	42	25	0.45
TB12B1-15	15	91.63	99.8	1610	14	42	25	0.53
TB12B1-16	16	97.65	105.5	1610	14	42	25	0.65
TB12B1-17	17	103.67	111.5	1610	14	42	25	0.75
TB12B1-18	18	109.71	118.0	2012	14	50	32	0.96
TB12B1-19	19	115.75	124.2	2012	14	50	32	1.05
TB12B1-20	20	121.78	129.7	2012	14	50	32	1.15
TB12B1-21	21	127.82	136.0	2517	19	65	45	1.45
TB12B1-22	22	133.86	141.8	2517	19	65	45	1.57
TB12B1-23	23	139.90	149.0	2517	19	65	45	1.91
TB12B1-24	24	145.94	153.9	2517	19	65	45	2.02
TB12B1-25	25	152.00	160.0	2517	19	65	45	2.14
TB12B1-26	26	158.04	165.9	2517	19	65	45	2.26
TB12B1-27	27	164.09	172.3	2517	19	65	45	2.40
TB12B1-28	28	170.13	178.0	2517	19	65	45	2.58
TB12B1-30	30	182.25	190.5	2517	19	65	45	2.83
TB12B1-38	38	230.69	239.0	2517	19	65	45	4.77
TB12B1-45	45	273.10	282.5	2517	19	65	45	6.00
TB12B1-57	57	345.81	355.4	2517	19	65	45	8.33
Cast Iron Wheels								
TB12B1-57	57	345.81	354.0	2517	19	65	45	6.0
TB12B1-76	76	460.99	469.9	2517	19	65	45	8.1
TB12B1-95	95	576.17	585.1	2517	19	65	45	12.0
TB12B1-114	114	691.36	700.6	2525	19	65	63	22.5

Duplex Chain No. 12B-2 - Tooth Width B_2 - 30.3mm

TB12B2-15	15	91.63	99.8	1610	14	42	30	0.68
TB12B2-16	16	97.65	105.5	1610	14	42	30	0.88
TB12B2-17	17	103.67	111.5	1610	14	42	30	1.07
TB12B2-18	18	109.71	118.0	2012	14	50	32	1.05
TB12B2-19	19	115.75	124.2	2012	14	50	32	1.29
TB12B2-20	20	121.78	129.7	2517	19	65	45	1.52
TB12B2-21	21	127.82	136.0	2517	19	65	45	1.76
TB12B2-22	22	133.86	141.8	2517	19	65	45	2.02
TB12B2-23	23	139.90	149.0	2517	19	65	45	2.32
TB12B2-24	24	145.94	153.9	2517	19	65	45	2.62
TB12B2-25	25	152.00	160.0	2517	19	65	45	2.94
TB12B2-26	26	158.04	165.9	2517	19	65	45	3.26
TB12B2-27	27	164.09	172.3	2517	19	65	45	3.60
TB12B2-28	28	170.13	178.0	2517	19	65	45	3.96
TB12B2-30	30	182.25	190.5	2517	19	65	45	4.71
TB12B2-38	38	230.69	239.0	3020	25	75	51	8.63
Cast Iron Wheels								
TB12B2-45	45	273.10	282.5	3020	25	75	51	7.6
TB12B2-57	57	345.81	354.0	3020	25	75	51	9.1
TB12B2-76	76	460.99	469.9	3020	25	75	51	14.2
TB12B2-95	95	576.17	585.1	3020	25	75	51	16.1
TB12B2-114	114	691.36	700.6	3030	25	75	76	24.0

Triplex Chain No. 12B-3 - Tooth Width B_3 - 49.8mm

TB12B3-15	15	91.63	99.8	1615	14	42	50	1.02
TB12B3-17	17	103.67	111.5	2012	14	50	50	1.33
TB12B3-19	19	115.75	124.2	2012	14	50	50	2.03
TB12B3-21	21	127.82	136.0	2517	19	65	50	2.29
TB12B3-23	23	139.90	149.0	2517	19	65	50	3.16
TB12B3-25	25	152.00	160.0	2517	19	65	50	4.06
TB12B3-27	27	164.09	172.3	3020	25	75	51	3.94
TB12B3-30	30	182.25	190.5	3020	25	75	51	5.67
TB12B3-38	38	230.69	239.0	3020	25	75	51	12.85
TB12B3-45	45	273.10	282.5	3020	25	75	51	18.00
Cast Iron Wheels								
TB12B3-45	45	273.10	282.5	3020	25	75	51	10.5
TB12B3-57	57	345.81	354.0	3020	25	75	51	13.4
TB12B3-76	76	460.99	469.9	3020	25	75	51	19.5
TB12B3-95	95	576.17	585.1	3030	25	75	76	30.0
TB12B3-114	114	691.36	700.6	3030	25	75	76	44.0

All dimensions in mm. Details Taper Bore Bushes refer pp 38/39.

Tel +44(0) 121 360 0155

Fax +44(0) 121 325 1079

Email sales@crossmorse.com

Taper Bore Sprockets for 1" Pitch British Standard Chains Type 16B

Conforming to ISO Std 606

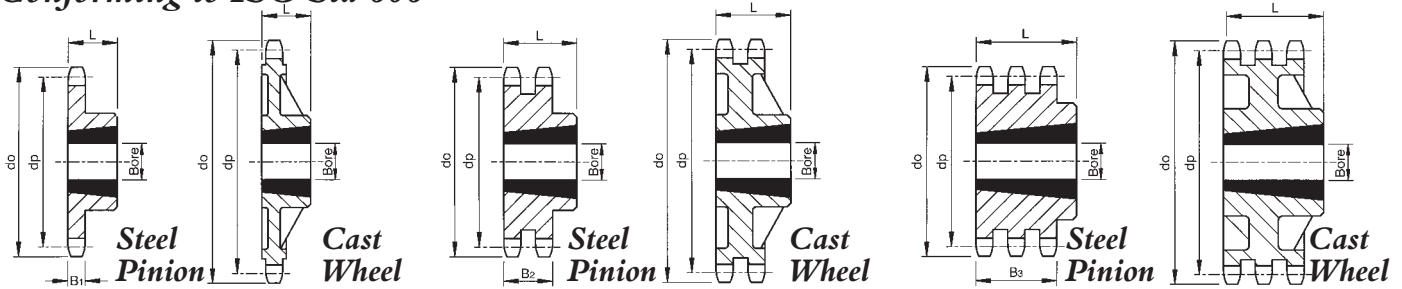

Simplex Sprockets

Chain No. 16B-1

Duplex Sprockets

Chain No. 16B-2

Triplex Sprockets

Chain No. 16B-3

Cat. No.	No. Teeth	Pitch Circle Ø dp	Outside Ø do	Taper Bore Bush			Length L	Approx. Weight kg
				Bush No.	Min. Bore	Max. Bore		

Simplex Chain No. 16B-1 - Tooth Width B₁ - 16.2mm

TB16B1-13	13	106.12	117.0	1610	14	42	25	0.7
TB16B1-14	14	114.15	125.0	1610	14	42	25	0.9
TB16B1-15	15	122.17	133.0	1610	14	42	25	1.1
TB16B1-16	16	130.20	141.0	2012	14	50	32	1.7
TB16B1-17	17	138.22	149.0	2012	14	50	32	1.8
TB16B1-18	18	146.28	157.0	2517	19	65	45	2.3
TB16B1-19	19	154.33	165.2	2517	19	65	45	2.5
TB16B1-20	20	162.38	173.2	2517	19	65	45	2.7
TB16B1-21	21	170.43	181.2	2517	19	65	45	3.0
TB16B1-22	22	178.48	189.3	2517	19	65	45	3.2
TB16B1-23	23	186.53	197.5	2517	19	65	45	3.4
TB16B1-24	24	194.59	205.5	2517	19	65	45	3.8
TB16B1-25	25	202.66	213.5	2517	19	65	45	4.1
TB16B1-26	26	210.72	221.6	2517	19	65	45	4.5
TB16B1-27	27	218.79	229.6	2517	19	65	45	4.8
TB16B1-28	28	226.85	237.7	2517	19	65	45	5.4
TB16B1-30	30	243.00	254.0	3020	25	75	51	7.9
TB16B1-38	38	307.59	320.7	3020	25	75	51	8.5
TB16B1-45	45	364.13	377.0	3020	25	75	51	10.7

Cast Iron Wheels

TB16B1-57	57	461.08	474.0	3020	25	75	51	12.0
TB16B1-76	76	614.65	627.0	3020	25	75	51	18.0
TB16B1-95	95	768.22	781.0	3020	25	75	51	28.0
TB16B1-114	114	921.81	933.0	3030	25	75	76	40.0

Duplex Chain No. 16B-2 - Tooth Width B₂ - 47.7mm

TB16B2-15	15	122.17	133.0	2012	14	50	48	2.1
TB16B2-16	16	130.20	141.0	2517	19	65	48	2.1
TB16B2-17	17	138.22	149.0	2517	19	65	48	2.5
TB16B2-18	18	146.28	157.0	2517	19	65	48	3.1
TB16B2-19	19	154.33	165.2	2517	19	65	48	3.8
TB16B2-20	20	162.38	173.2	2517	19	65	48	4.5
TB16B2-21	21	170.43	181.2	3020	25	75	51	4.2
TB16B2-22	22	178.48	189.3	3020	25	75	51	5.0
TB16B2-23	23	186.53	197.5	3020	25	75	51	5.8
TB16B2-24	24	194.59	205.5	3020	25	75	51	6.7
TB16B2-25	25	202.66	213.5	3020	25	75	51	7.6
TB16B2-26	26	210.72	221.6	3020	25	75	51	8.3
TB16B2-27	27	218.79	229.6	3020	25	75	51	9.0
TB16B2-28	28	226.85	237.7	3020	25	75	51	9.5
TB16B2-30	30	243.00	254.0	3020	25	75	51	10.0
TB16B2-38	38	307.59	320.7	3020	25	75	51	12.0
TB16B2-45	45	364.13	377.1	3020	25	75	51	35.0
TB16B2-57	57	461.07	474.0	3525	32	90	65	60.0

Cast Iron Wheels

TB16B2-45	45	364.13	377.0	3020	25	75	51	15.0
TB16B2-57	57	461.08	474.0	3525	32	90	65	26.2
TB16B2-76	76	614.65	627.0	3525	32	90	65	40.5
TB16B2-95	95	768.22	781.0	3525	32	90	65	55.0
TB16B2-114	114	921.81	933.0	4040	40	100	102	65.0

Triplex Chain No. 16B-3 - Tooth Width B₃ - 79.6mm

TB16B3-17	17	138.22	149.0	2517	19	65	80	4.2
TB16B3-19	19	154.33	165.2	3020	25	75	80	3.6
TB16B3-21	21	170.43	181.2	3020	25	75	80	6.1
TB16B3-23	23	186.53	197.5	3525	32	90	80	7.0
TB16B3-25	25	202.66	213.5	3525	32	90	80	9.5
TB16B3-27	27	218.79	229.6	3525	32	90	80	12.5
TB16B3-30	30	243.00	254.0	3525	32	90	80	18.0
TB16B3-38	38	307.59	320.0	3525	32	90	80	23.0
TB16B3-45	45	364.13	377.1	4030	40	100	80	53.0
TB16B3-57	57	461.07	474.0	4030	40	100	80	90.0
TB16B3-76	76	614.65	627.0	4030	40	100	80	170.5

Cast Iron Wheels

TB16B3-45	45	364.13	377.0	4030	40	100	80	32.0
TB16B3-57	57	461.08	474.0	4030	40	100	80	40.0
TB16B3-76	76	614.65	627.0	4030	40	100	80	58.0
TB16B3-95	95	768.22	781.0	4030	40	100	80	85.0
TB16B3-114	114	921.81	933.0	4545	55	110	114	90.0

All dimensions in mm. Details Taper Bore Bushes refer pp 38/39.

Taper Bore Sprockets for 1¹/₄" Pitch British Standard Chains Type 20B

Conforming to ISO Std 606

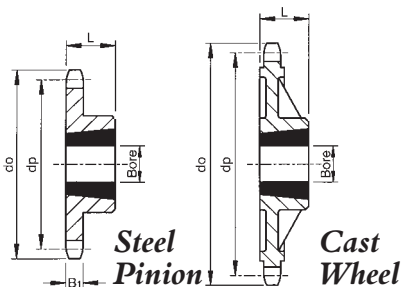

Simplex Sprockets
Chain No. 20B-1

Cat. No.	No. Teeth	Pitch Circle Ø dp	Outside Ø do	Taper Bore Bush			Length L	Approx. Weight kg
				Bush No.	Min. Bore	Max. Bore		

Simplex Chain No. 20B-1 - Tooth Width B₁ - 18.5mm

TB20B1-13	13	132.65	147.8	2012	14	50	32	1.53
TB20B1-14	14	142.68	157.8	2517	19	65	45	1.83
TB20B1-15	15	152.72	167.9	2517	19	65	45	2.37
TB20B1-16	16	162.75	177.9	2517	19	65	45	2.72
TB20B1-17	17	172.78	187.9	2517	19	65	45	3.04
TB20B1-18	18	182.85	198.0	2517	19	65	45	3.46
TB20B1-19	19	192.91	207.1	2517	19	65	45	3.90
TB20B1-20	20	202.98	218.1	2517	19	65	45	4.30
TB20B1-21	21	213.04	228.2	2517	19	65	45	4.74
TB20B1-23	23	233.17	248.3	2517	19	65	45	5.72
TB20B1-25	25	253.33	268.5	2517	19	65	45	6.50
TB20B1-27	27	273.40	288.6	3020	25	75	51	9.00
TB20B1-30	30	303.75	318.9	3020	25	75	51	10.90
TB20B1-38	38	384.49	399.6	3020	25	75	51	18.00
TB20B1-45	45	455.17	470.3	3020	25	75	51	24.00
TB20B1-57	57	576.36	591.5	3020	25	75	51	38.50
TB20B1-76	76	768.32	783.5	3020	25	75	51	68.00
Cast Iron Wheels								
TB20B1-38	38	384.49	399.6	3020	25	75	51	12.6
TB20B1-45	45	455.17	470.3	3020	25	75	51	17.0
TB20B1-57	57	576.36	591.5	3020	25	75	51	25.6
TB20B1-76	76	768.32	783.5	3020	25	75	51	39.0

Rivet Extractors

Roller Chain tools reduce time both in the field and in the shop and are a necessity for disconnecting roller chains from bulk length, or for chain repair and alteration purposes. The tool requires virtually no maintenance, all parts being produced from high grade steels, with moving parts hardened for maximum strength and wear resistant qualities. When ordering rivet extractors, always state the extractor number as indicated below.



Tool Number	Chain Pitch	Roller Chain Sizes		
		B.S.	ANSI	Ext. Pitch
36	1/4" - 3/4"	05B-12B	25-60	208-212
610	3/4" - 1 1/4"	12B-20B	60-100	212-216
1220	1 1/2" - 2"	24B-32B	120-160	

Chain Pullers

This unique tool was designed to make roller chain installation quick and easy both in the field and the workshop.

In use the pullers jaws are opened by releasing the screw, and then hooked into each open end of the chain. The screw is tightened to bring the two ends of the chain almost together with bush centres pitch length apart. The connecting link is then easily fitted to the chain. Two sizes of unit are available as below:-

Tool Number	Chain Pitch	Roller Chain Sizes		
		B.S.	ANSI	Ext. Pitch
35	3/8" - 3/4"	06B-12B	35-60	208-212
50	1/2" - 1"	08B-16B	40-80	208-216
80	1" - 2"	16B-32B	80-160	216-224

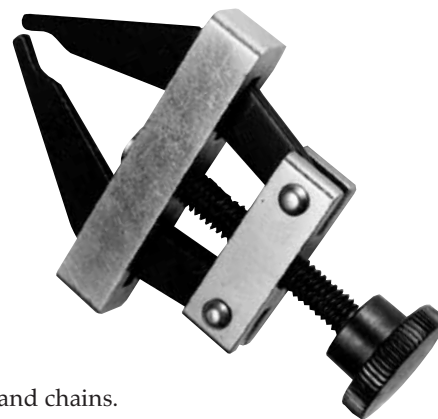

Although primarily for Simplex chains, these pullers can also be used for multi-strand chains.

For larger pitch chains other tools are available to assist in assembly and disassembly including Chain Vice, and Hook-up tools suitable for both Inverted Tooth and Roller Chains of up to 2 1/2 inch pitch and 12 inch width. Knock-down and Rivet Tools can also be supplied to order, ensuring correct assembly of rivetted endless chains.

These tools, combined with the Chains, Sprockets, and Idlers ensure that you only need contact -

- CROSS+MORSE for the TOTAL CHAIN TRANSMISSION PACKAGE -

Tel +44(0) 121 360 0155

Fax +44(0) 121 325 1079

Email sales@crossmorse.com

Taper Bushes



Email sales@crossmorse.com
Fax +44(0) 121 325 1079
Tel +44(0) 121 360 0155

Taper bushes provide a low cost, simple, quick method of securing sprocket, pulleys and couplings to a wide range of standard metric and imperial dimensioned shafts of general commercial tolerances and finish.

The taper surfaces on the bush and mating hub are driven together by high tensile screws, causing the split bush to be firmly contracted onto the shaft. The strong clamping force which can be achieved enables transmission of high torque without the problems of fretting associated with simple keyseated drives.

The design ensures quick, easy installation of sprockets and pulleys onto shafts with simple positioning for alignment. Positive jacking-off of the bush during removal ensures quick disassembly without normal problems of seizure between shaft and pulley. The standard bushes shown opposite are suitable for taper bore sprockets shown on pages 32-37, taper bored hubs on page 69, and the taper bored pulleys offered in the timing belt catalogue.

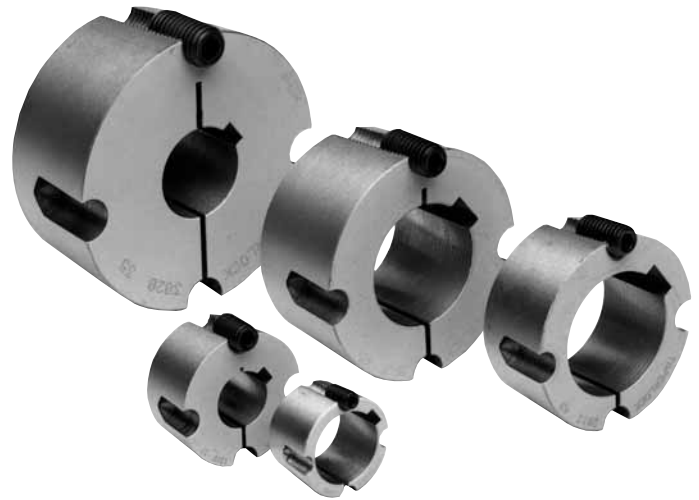

Instructions - Installation and Removal

Installation

1. Remove protective coating from the bore and outside bush, and bore of hub. After ensuring the mating tapered surfaces are completely clean, insert bush in hub so that holes line up.
2. Oil thread and point of grub screws, or thread and under head of cap screws. Place screws loosely in holes threaded in hub, shown thus  in diagram.
3. Clean shaft and fit hub and bush to shaft. Locate in position, remembering bush will nip the shaft first and then hub will be drawn on to the bush.
4. Using a hexagon wrench tighten screws gradually and alternately until all are pulled up very tightly. Use a piece of pipe on wrench to increase leverage.
5. When a key is not used, hammer against large end of bush using a block or sleeve to prevent damage. Screws will now turn a little more. Repeat this alternate hammering and screw tightening once or twice. After drive has run under load for a short time, check tightness of screws.
6. If a key is to be fitted, do so after the bush has been tightened on to the shaft, and then fit a parallel key that is side fitting with top clearance.
7. Fill empty holes with grease to exclude dirt.

Removal

1. Slacken all screws by several turns, remove one or two according to number of jacking off holes thus  in diagram. Insert screws in jacking off holes after oiling thread and point of grub screws or thread under head of cap screws.
2. Tighten screws alternately until bush is loosened in hub and assembly is free on the shaft.
3. Remove assembly from shaft.

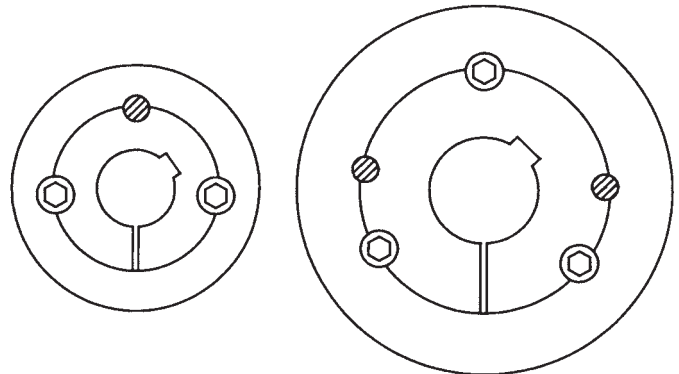

Bush with 2 Grub Screws
(Sizes 1008-3030)

Bush with 3 Grub Screws
(Sizes 3535 and above)

Installation and Design Recommendations

It is recommended that a key should be fitted with bushes in rigid and flexible couplings, timing belt and chain drives, and wherever loads of a heavy pulsating nature are encountered. All keyways are parallel keyways to British Standard 4235 Part 1 : 1972 for metric dimensional shafts, or British Standard 46 Part 1 : 1958 for imperial dimensional shafts, with the exception of those marked* in the tables which are slightly shallower. Where a key is used it should be parallel type with side fitting and top clearance.

It is not recommended to use taper bushes with maximum or minimum bore sizes on drives where high shock loads may be encountered.

Taper Bushes

Bush Dimensions



Bush No.	Approx. Weight kg	Bush Dimensions					Metric Bore Bushes					Imperial Bore Sizes						
		Length mm	o.d. large end of taper mm	Grub Screws			Bore sizes available mm				Keyway mm		Bore sizes available inches		Keyway Inches			
				No.	Screw Size	Key Size mm					Width	Depth at Centre			Width	Depth at Side		
1008	0.11	22.2	35	2	1/4" x 1/2" B.S.W.	3	9	11	10	12	3	1.4	3/8	1/2	1/8	3/16	1/16	3/32
1108	0.12	22.2	38	2	1/4" x 1/2" B.S.W.	3	9	11	10	12	3	1.4	3/8	1/2	1/8	3/16	1/16	3/32
1210	0.23	25.4	48	2	3/8" x 5/8" B.S.W.	5	14	11	16	12	4	1.8	5/8	3/4	1/8	3/16	1/16	3/32
1215	0.35	38.1					18	19	20	22	6	2.8	7/8	1	1/4	5/16	1/8	1/8
1310	0.28	25.4	51	2	3/8" x 5/8" B.S.W.	5	14	16	16	22	5	2.3	5/8	3/4	1/8	3/16	1/16	3/32
1610	0.35	25.4	57	2	3/8" x 5/8" B.S.W.	5	14	16	22	22	5	2.3	5/8	3/4	1/8	3/16	1/16	3/32
1615	0.45	38.1					18	19	20	22	6	2.8	7/8	1	1/4	5/16	1/8	1/8
2012	0.68	31.8	70	2	7/16" x 7/8" B.S.W.	6	14	15	16	22	5	2.3	7/8	1	3/16	1/4	3/32	1/8
2517	1.5	44.5	86	2	1/2" x 1" B.S.W.	6	24	19	20	22	6	2.8	7/8	1	5/16	3/8	1/8	1/8
2525	1.9	63					32	25	28	30	8	3.3	1 1/8	1 1/4	7/16	1/2	5/32	5/32
3020	2.7	50.8	108	2	5/8" x 1 1/4" B.S.W.	8	25	28	30	30	8	3.3	1 3/8	1 1/2	3/8	7/16	1/8	5/32
3030	3.6	76					32	35	38	42	10	3.3	1 5/8	1 3/4	1/2	5/8	7/32	7/32
3525	4.0	63	127	3	1/2" x 1 1/2" B.S.W.	10	45	48	50	55	10	3.3	1 5/8	1 1/2	7/16	3/8	5/32	1/8
3535	5.0	89					60	65	70	75	12	3.3	2 1/4	2 1/2	5/8	3/4	7/32	1/4
4030	6.5	76	146	3	5/8" x 1 3/4" B.S.W.	12	40	42	50	55	12	3.3	2 1/4	2 3/8	7/16	1/2	5/32	5/32
4040	7.7	102					48	50	55	60	14	3.8	2 3/4	3	5/8	3/4	7/32	1/4
4535	8	89	162	3	3/4" x 2" B.S.W.	14	60	65	75	80	16	4.3	2 3/4	3	5/8	3/4	7/32	1/4
4545	10	114					70	75	80	85	18	4.4	3 1/4	4	7/8	1	5/16	3/8
5040	12	102	178	3	7/8" x 2 1/4" B.S.W.	17	70	75	85	90	20	4.9	3 1/4	4	1 1/4	3/4	1/4	1/4
5050	14	127					80	85	90	95	22	5.4	4 1/4	4 1/2	7/8	1 1/4	5/16	3/8
							100	105	110	110	28	6.4	4 1/2	5	1 1/4	1 1/4	5/16	5/16*
							115	120	125	125	32	7.4						

†Bore size 65mm has keyway 2.3mm deep on 2525 Bush

* Shallow Key not to B.S. 46 Part 1.

**Shallow Key not to B.S. 4235 Part 1.

Tel +44(0) 121 360 0155

Fax +44(0) 121 325 1079

Email sales@crossmorse.com

Standard Sprockets for 8mm Pitch British Standard Chain Type 05B

Conforming to ISO Std 606



Email sales@crossmorse.com Fax +44(0) 121 325 1079 Tel +44(0) 121 360 0155

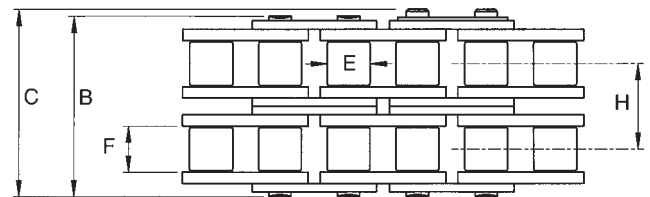
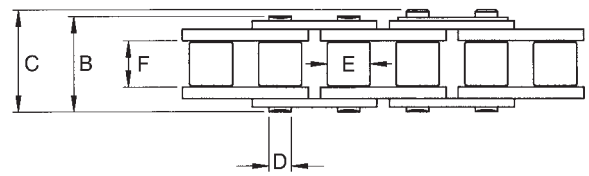
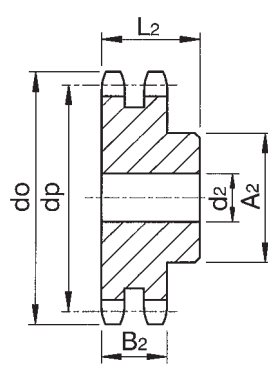
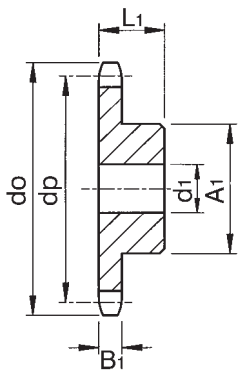

Simplex Sprockets

Chain No. 05B1-1
Pitch 8.0mm
E Roller Diameter 5.0mm
F Inside Width 3.0mm
B₁ Tooth Width 2.8mm

Duplex Sprockets

Chain No. 05B-2
Pitch 8.0mm
E Roller Diameter 5.0mm
F Inside Width 3.0mm
B₂ Tooth Width 8.3mm

Chain Specifications

Chain No.	Simplex 05B-1	Duplex 05B-2
Plate Depth	7.1	7.1
B Pin Length	8.6	14.3
C Overall Width	11.7	17.4
D Pin Diameter	2.31	2.31
Tensile Strength N	4600	7500
Weight per metre kg	0.18	0.36

No. Teeth Z	Pitch Circle Ø dp	Outside Ø do	Simplex Sprocket						Duplex Sprocket					
			Cat. No.	Min. † Bore d ₁	Max. Bore	L.T.B. L ₁	Hub Ø A ₁	App. Weight kg	Cat. No.	Min. † Bore d ₂	Max. Bore	L.T.B. L ₂	Hub Ø A ₂	App. Weight kg
Steel Pinions														
8	20.90	24.0	05B1-08	6	8	12	13	.013	05B2-08	8	8	18	12	.018
9	23.39	26.6	05B1-09	6	10	12	15	.018	05B2-09	8	10	18	15	.027
10	25.89	29.2	05B1-10	8	11	12	17	.023	05B2-10	8	11	18	17	.033
11	28.39	31.7	05B1-11	8	12	13	18	.028	05B2-11	10	12	18	19	.043
12	30.91	34.2	05B1-12	8	13	13	20	.035	05B2-12	10	13	18	21	.054
13	33.42	36.7	05B1-13	8	14	13	23	.045	05B2-13	10	15	18	24	.07
14	35.95	39.2	05B1-14	8	16	13	25	.055	05B2-14	10	17	18	26	.08
15	38.48	41.7	05B1-15	8	19	13	28	.07	05B2-15	10	20	18	29	.10
16	41.01	44.3	05B1-16	8	20	14	30	.08	05B2-16	10	21	20	32	.13
17	43.53	46.8	05B1-17	8	20	14	30	.085	05B2-17	10	23	20	34	.15
18	46.07	49.3	05B1-18	8	20	14	30	.09	05B2-18	10	25	20	37	.17
19	48.61	51.9	05B1-19	8	20	14	30	.09	05B2-19	10	26	20	39	.20
20	51.14	54.4	05B1-20	8	20	14	30	.10	05B2-20	10	27	20	40	.21
21	53.68	57.0	05B1-21	8	24	14	35	.12	05B2-21	10	27	20	40	.25
22	56.21	59.5	05B1-22	8	24	14	35	.13	05B2-22	10	27	20	40	.26
23	58.75	62.0	05B1-23	8	24	14	35	.13	05B2-23	10	27	20	40	.28
24	61.29	64.6	05B1-24	8	24	14	35	.14	05B2-24	10	27	20	40	.29
25	63.83	67.5	05B1-25	8	24	14	35	.14	05B2-25	10	27	20	40	.31
26	66.37	69.5	05B1-26	10	27	16	40	.19	05B2-26	12	34	22	50	.39
27	68.91	72.2	05B1-27	10	27	16	40	.20	05B2-27	12	34	22	50	.40
28	71.45	74.8	05B1-28	10	27	16	40	.20	05B2-28	12	34	22	50	.42
29	73.99	77.3	05B1-29	10	27	16	40	.21	05B2-29	12	34	22	50	.44
30	76.53	79.8	05B1-30	10	27	16	40	.21	05B2-30	12	34	22	50	.46
31	79.08	82.4	05B1-31	12	27	16	40	.22	05B2-31	12	40	22	60	.57
32	81.61	84.9	05B1-32	12	27	16	40	.22	05B2-32	12	40	22	60	.59
33	84.16	87.5	05B1-33	12	27	16	40	.23	05B2-33	12	40	22	60	.61
34	86.70	90.0	05B1-34	12	27	16	40	.24	05B2-34	12	40	22	60	.63
35	89.25	92.5	05B1-35	12	27	16	40	.24	05B2-35	12	40	22	60	.65
36	91.79	95.0	05B1-36	12	27	16	40	.25	05B2-36	12	40	22	60	.67
37	94.33	97.6	05B1-37	12	27	16	40	.26	05B2-37	12	40	22	60	.70
38	96.88	100.2	05B1-38	12	27	16	40	.27	05B2-38	12	40	22	60	.72
39	99.42	102.7	05B1-39	12	27	16	40	.28	05B2-39	12	40	22	60	.74
40	101.97	105.3	05B1-40	12	27	16	40	.29	05B2-40	12	40	22	60	.77
45	114.69	118.0	05B1-45	12	40	20	60	.58						
50	127.41	130.7	05B1-50	12	40	20	60	.63						
57	145.22	148.6	05B1-57	14	52	20	80	1.00						
76	193.59	197.7	05B1-76	20	52	25	80	1.60						

All dimensions in mm. †Min. tolerance bore which can be machined in sprocket. Material:-Steel Pinions 8 to 40 tooth minimum U.T.S. 600N/mm² - Above 40T - 410N/mm²

Finished Bored and Keyed Sprockets

All standard plain bore sprockets can be supplied finish bored, keywayed and with setscrews to customers' specifications. Where possible standard bores and keyways should always be used (Refer to p95 for details). For idler applications sprockets can be supplied fitted with phosphor bronze or sintered bushes with bores up to a maximum indicated for sprocket bores. All modifications are offered on our 48 hour rework service. Steel pinions 8 to 40 tooth can be supplied with teeth induction hardened to 45Rc.

Standard Sprockets for 3/8" Pitch British Standard Chains Type 06B

Conforming to ISO Std 606

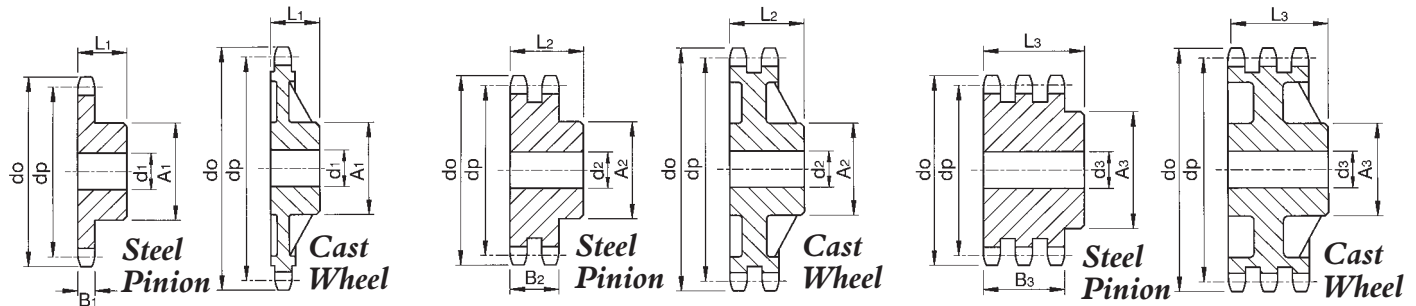

Simplex Sprockets

Chain No. 06B-1
Pitch 9.525mm
Roller Dia. 6.35mm
Inside Width 5.72mm
Overall Width 15.0mm
Tooth Width B₁ 5.3mm

Duplex Sprockets

Chain No. 06B-2
Pitch 9.525mm
Roller Dia. 6.35mm
Inside Width 5.72mm
Overall Width 25.1mm
Tooth Width B₂ 15.4mm

Triplex Sprockets

Chain No. 06B-3
Pitch 9.525mm
Roller Dia. 6.35mm
Inside Width 5.72mm
Overall Width 35.0mm
Tooth Width B₃ 25.6mm

No. Teeth Z	Pitch Circle Ø dp	Outside Ø do	Simplex Sprocket					Duplex Sprocket					Triplex Sprocket							
			Cat. No.	Min. † Bore d ₁	Max. Bore d ₁	L.T.B. L ₁	Hub Ø A ₁	App. Weight kg	Cat. No.	Min. † Bore d ₂	Max. Bore d ₂	L.T.B. L ₂	Hub Ø A ₂	App. Weight kg	Cat. No.	Min. † Bore d ₃	Max. Bore d ₃	L.T.B. L ₃	Hub Ø A ₃	App. Weight kg
Steel Pinions																				
8	24.89	28.0	06B1-08	8	10	22	15	.03	06B2-08	8	10	22	15	.04	06B3-08	8	10	32	15	.05
9	27.85	31.0	06B1-09	8	12	22	18	.05	06B2-09	8	12	22	18	.05	06B3-09	8	12	32	18	.07
10	30.82	34.0	06B1-10	8	13	22	20	.06	06B2-10	8	13	22	20	.07	06B3-10	8	13	32	20	.09
11	33.80	37.0	06B1-11	8	14	25	22	.08	06B2-11	10	14	25	22	.09	06B3-11	12	14	35	22	.12
12	36.80	40.0	06B1-12	8	16	25	25	.11	06B2-12	10	16	25	25	.12	06B3-12	12	16	35	25	.15
13	39.79	43.0	06B1-13	10	19	25	28	.13	06B2-13	10	19	25	28	.14	06B3-13	12	19	35	28	.19
14	42.80	46.3	06B1-14	10	20	25	31	.16	06B2-14	10	20	25	31	.17	06B3-14	12	20	35	31	.24
15	42.80	49.3	06B1-15	10	23	25	34	.19	06B2-15	10	23	25	34	.21	06B3-15	12	23	35	34	.28
16	48.82	52.3	06B1-16	10	25	28	37	.24	06B2-16	12	25	30	37	.27	06B3-16	12	25	35	37	.33
17	51.83	55.3	06B1-17	10	27	28	40	.29	06B2-17	12	27	30	40	.32	06B3-17	12	27	35	40	.39
18	54.85	58.3	06B1-18	10	29	28	43	.33	06B2-18	12	29	30	43	.37	06B3-18	12	29	35	43	.45
19	57.87	61.3	06B1-19	10	30	28	45	.37	06B2-19	12	31	30	46	.42	06B3-19	12	31	35	46	.51
20	60.89	64.3	06B1-20	10	31	28	46	.39	06B2-20	12	33	30	49	.48	06B3-20	12	33	35	49	.58
21	63.91	68.0	06B1-21	12	32	28	48	.42	06B2-21	16	35	30	52	.52	06B3-21	16	35	40	52	.70
22	66.93	71.0	06B1-22	12	34	28	50	.46	06B2-22	16	36	30	55	.58	06B3-22	16	36	40	55	.79
23	69.95	73.5	06B1-23	12	35	28	52	.50	06B2-23	16	38	30	58	.65	06B3-23	16	38	40	58	.88
24	72.97	77.0	06B1-24	12	36	28	54	.54	06B2-24	16	40	30	61	.72	06B3-24	16	40	40	61	.97
25	76.00	80.0	06B1-25	12	38	28	57	.61	06B2-25	16	43	30	64	.79	06B3-25	16	43	40	64	1.07
26	79.02	83.0	06B1-26	12	40	28	60	.67	06B2-26	16	44	30	67	.87	06B3-26	16	44	40	67	1.17
27	82.05	86.0	06B1-27	12	40	28	60	.73	06B2-27	16	46	30	70	.95	06B3-27	16	46	40	70	1.28
28	85.07	89.0	06B1-28	12	40	28	60	.81	06B2-28	16	48	30	73	1.03	06B3-28	16	48	40	73	1.39
29	88.09	92.0	06B1-29	12	40	28	60	.88	06B2-29	16	50	30	76	1.12	06B3-29	16	50	40	76	1.51
30	91.12	94.7	06B1-30	12	40	30	60	.92	06B2-30	16	53	30	79	1.21	06B3-30	16	53	40	79	1.63
31	94.15	98.3	06B1-31	14	43	30	65	.97	06B2-31	16	54	30	80	1.27	06B3-31	16	54	40	80	1.72
32	97.17	101.3	06B1-32	14	43	30	65	.99	06B2-32	16	54	30	80	1.32	06B3-32	16	54	40	80	1.81
33	100.20	104.3	06B1-33	14	43	30	65	1.01	06B2-33	16	54	30	80	1.38	06B3-33	16	54	40	80	1.90
34	103.23	107.3	06B1-34	14	43	30	65	1.03	06B2-34	16	54	30	80	1.43	06B3-34	16	57	40	85	2.06
35	106.26	110.4	06B1-35	14	43	30	65	1.05	06B2-35	16	54	30	80	1.49	06B3-35	16	57	40	85	2.16
36	109.29	113.4	06B1-36	16	46	30	70	1.07	06B2-36	16	60	30	90	1.55	06B3-36	16	60	40	90	2.23
37	112.32	116.4	06B1-37	16	46	30	70	1.09	06B2-37	16	60	30	90	1.61	06B3-37	16	60	40	90	2.43
38	115.35	119.5	06B1-38	16	46	30	70	1.11	06B2-38	16	60	30	90	1.67	06B3-38	16	60	40	90	2.62
39	118.37	122.5	06B1-39	16	46	30	70	1.13	06B2-39	16	60	30	90	1.74	06B3-39	16	60	40	90	2.72
40	121.40	125.5	06B1-40	16	46	30	70	1.16	06B2-40	16	60	30	90	1.80	06B3-40	16	60	40	90	2.92
42	127.46	131.6	06B1-42	16	54	32	*80	1.50	06B2-42	20	60	40	*90	2.54	06B3-42	20	60	56	*90	3.70
45	136.55	140.7	06B1-45	16	54	32	*80	1.58	06B2-45	20	60	40	*90	2.76	06B3-45	20	60	56	*90	4.06
48	145.64	149.7	06B1-48	20	54	32	*80	1.63	06B2-48	20	60	40	*90	2.99	06B3-48	20	60	56	*90	4.45
50	151.69	155.7	06B1-50	20	54	32	*80	1.69	06B2-50	20	60	40	*90	3.16	06B3-50	20	60	56	*90	4.72
57	172.91	176.9	06B1-57	20	54	32	*80	1.91	06B2-57	20	60	40	*90	3.79	06B3-57	20	60	56	*90	5.78
60	182.00	186.0	06B1-60	20	54	32	*80	2.01	06B2-60	20	60	40	*90	4.09	06B3-60	20	60	56	*90	6.28
Cast Iron Wheels																				
57	172.91	176.9	06B1-57	19	42	32	70	1.60	06B2-57	19	48	40	80	2.50	06B3-57	23	54	56	90	3.60
76	230.49	234.9	06B1-76	19	42	32	70	2.10	06B2-76	19	48	40	80	3.10	06B3-76	23	60	56	100	4.00
95	288.08	292.5	06B1-95	19	48	40	80	3.50	06B2-95	19	54	45	90	4.60	06B3-95	23	60	56	100	6.50
114	345.68	349.6	06B1-114	19	48	40	80	4.20	06B2-114	19	54	45	90	5.30	06B3-114	23	60	56	100	8.00
150	454.82	459.2	06B1-150	23	54	45	90	9.00	06B2-150	23	60	50	100	10.50	06B3-150	23	75	60	125	14.00

All dimensions in mm.

†Min. toleranced bore which can be machined in sprocket.

Steel Pinions 8 to 40 tooth minimum U.T.S. 600N/mm² - Above 40T - 410N/mm²

Stock Sprockets can be reworked to customers bore and keyway requirements, on 48 hour service.

Steel pinions 8 to 40 tooth can be supplied with teeth induction hardened to 45Rc.

*Sprockets with an asterisk on hub Ø may be of fabricated construction.

Standard Sprockets for 1/2" Pitch Narrow Series Roller Chains



Email sales@crossmorse.com

Fax +44(0) 121 325 1079

Fax +44(0) 121 360 0155

Tel +44(0) 121 360 0155

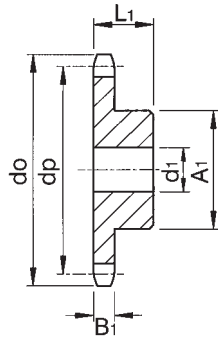

Chain No. 081
Pitch 12.7mm
Roller Dia. 7.75mm
Inside Width 3.3mm
Tooth Width B 3.0mm

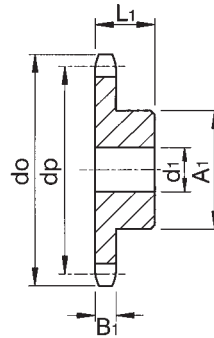

Chain No. 083
Pitch 12.7mm
Roller Dia. 7.75mm
Inside Width 4.88mm
Tooth Width B 4.5mm

No. Teeth Z	Pitch Circle Ø dp	Outside Ø do	Simplex Sprocket for 081 Chain						Sprockets for 083 Chain					
			Cat. No.	Min. † Bore d ₁	Max. Bore d ₁	L.T.B. L ₁	Hub Ø A ₁	App. Weight kg	Cat. No.	Min. † Bore d ₁	Max. Bore d ₁	L.T.B. L ₁	Hub Ø A ₁	App. Weight kg
Steel Pinions														
8	33.18	37.2	081-08	8	13	14	21	.04	083-08	8	13	14	21	.04
9	37.13	41.5	081-09	8	16	14	25	.06	083-09	8	16	14	25	.06
10	41.10	46.2	081-10	8	19	14	28	.08	083-10	8	19	14	28	.08
11	45.07	49.6	081-11	8	20	16	31	.10	083-11	8	20	16	31	.11
12	49.07	53.9	081-12	8	24	16	35	.13	083-12	8	24	16	35	.14
13	53.06	58.4	081-13	8	26	16	39	.16	083-13	8	26	16	39	.17
14	57.07	62.8	081-14	8	29	16	43	.19	083-14	8	29	16	43	.20
15	61.09	66.8	081-15	8	31	16	47	.23	083-15	8	31	16	47	.24
16	65.10	70.9	081-16	10	34	18	50	.29	083-16	10	34	18	50	.30
17	69.11	74.9	081-17	10	34	18	50	.31	083-17	10	34	18	50	.32
18	73.14	78.9	081-18	10	34	18	50	.32	083-18	10	34	18	50	.33
19	77.16	82.9	081-19	10	34	18	50	.34	083-19	10	34	18	50	.34
20	81.19	86.9	081-20	10	34	18	50	.35	083-20	10	34	18	50	.36
21	85.22	91.0	081-21	12	40	20	60	.49	083-21	12	40	20	60	.51
22	89.24	95.0	081-22	12	40	20	60	.51	083-22	12	40	20	60	.53
23	93.27	99.0	081-23	12	40	20	60	.53	083-23	12	40	20	60	.55
24	97.29	103.0	081-24	12	40	20	60	.55	083-24	12	40	20	60	.57
25	101.33	107.1	081-25	12	40	20	60	.57	083-25	12	40	20	60	.59
26	105.36	111.2	081-26	16	46	20	70	.68	083-26	16	46	20	70	.72
27	109.40	115.4	081-27	16	46	20	70	.70	083-27	16	46	20	70	.74
28	113.42	119.4	081-28	16	46	20	70	.72	083-28	16	46	20	70	.77
29	117.46	123.4	081-29	16	46	20	70	.74	083-29	16	46	20	70	.79
30	121.50	127.5	081-30	16	46	20	70	.75	083-30	16	46	20	70	.82
31	125.54	131.5	081-31	16	46	20	70	.77	083-31	16	46	20	70	.84
32	129.56	135.5	081-32	16	46	20	70	.78	083-32	16	46	20	70	.87
33	133.60	139.6	081-33	16	46	20	70	.80	083-33	16	46	20	70	.90
34	137.64	143.6	081-34	16	46	20	70	.82	083-34	16	46	20	70	.93
35	141.68	147.6	081-35	16	46	20	70	.85	083-35	16	46	20	70	.96
36	145.72	151.7	081-36	16	46	25	70	1.00	083-36	16	46	25	70	1.13
37	149.76	155.7	081-37	16	46	25	70	1.02	083-37	16	46	25	70	1.16
38	153.80	159.8	081-38	16	46	25	70	1.05	083-38	16	46	25	70	1.20
39	157.83	163.8	081-39	16	46	25	70	1.08	083-39	16	46	25	70	1.23
40	161.87	167.8	081-40	16	46	25	70	1.10	083-40	16	46	25	70	1.26

All dimensions in mm. Material:-Steel Pinions 8 to 40 tooth minimum U.T.S. 600N/mm² - Above 40T - 410N/mm²

Stock Sprockets can be reworked to customers bore and keyway requirements.

†Min. tolerance bore which can be machined in sprocket.

Steel pinions 8 to 40 tooth can be supplied with teeth induction hardened to 45Rc.

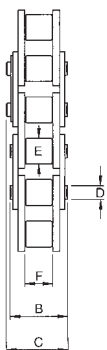

Chains for Sprocket Types 081, 083 and 08L

Sprocket Ref.	Chain Ref.	Pin Length B	Overall Width C	Pin Diameter D	Roller Diameter E	Inside Width F	Ultimate Strength N	Weight per Metre kg
081	081	10.2	11.7	3.60	7.75	3.30	8,200	0.28
083	083	12.9	14.4	4.09	7.75	4.88	12,000	0.42
	084	14.5	16.3	4.09	7.75	4.88	16,000	0.59
	08N	10.9	13.7	3.60	7.75	4.88	8,200	0.33

Standard Sprockets for 1/2" Pitch British Standard Chains Type 08B

Conforming to ISO Std 606



Tel +44(0) 121 360 0155 Fax +44(0) 121 325 1079 Email sales@crossmorse.com

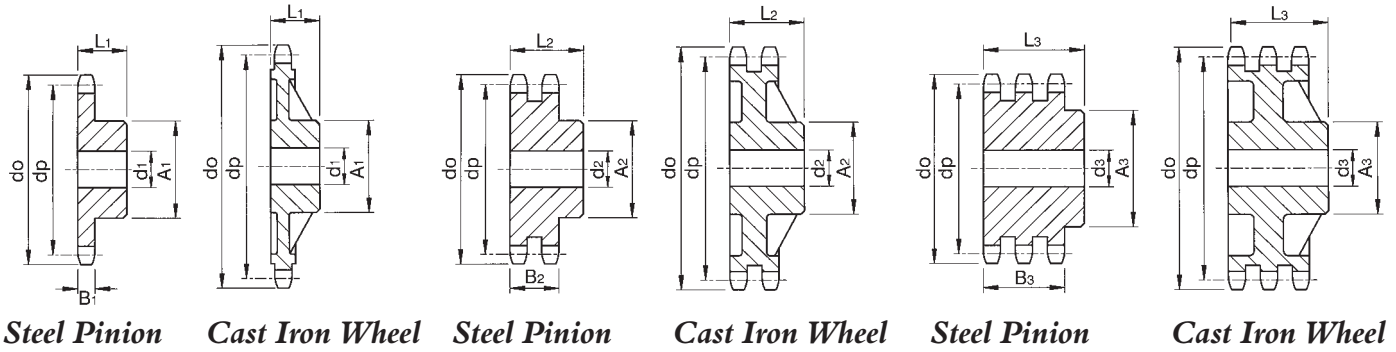

Simplex Sprockets

Chain No. 08B-1	
Pitch	12.7mm
Roller Dia.	8.51mm
Inside Width	7.75mm
Overall Width	18.3mm
Tooth Width B ₁	7.2mm

Duplex Sprockets

Chain No. 08B-2	
Pitch	12.7mm
Roller Dia.	8.51mm
Inside Width	7.75mm
Overall Width	32.1mm
Tooth Width B ₂	21.0mm

Triplex Sprockets

Chain No. 08B-3	
Pitch	12.7mm
Roller Dia.	8.51mm
Inside Width	7.75mm
Overall Width	46.1mm
Tooth Width B ₃	34.9mm

No. Teeth Z	Pitch Circle Ø dp	Outside Ø do	Simplex Sprocket						Duplex Sprocket						Triplex Sprocket					
			Cat. No.	Min.† Bore d ₁	Max. Bore d ₁	L.T.B. L ₁	Hub Ø A ₁	App. Weight kg	Cat. No.	Min.† Bore d ₂	Max. Bore d ₂	L.T.B. L ₂	Hub Ø A ₂	App. Weight kg	Cat. No.	Min.† Bore d ₃	Max. Bore d ₃	L.T.B. L ₃	Hub Ø A ₃	App. Weight kg
Steel Pinions																				
8	33.18	37.2	08B1-08	10	13	25	20	.07	08B2-08	10	13	32	20	.10	08B3-08	10	13	46	20	.14
9	37.13	41.0	08B1-09	10	15	25	24	.10	08B2-09	10	15	32	24	.13	08B3-09	12	15	46	24	.18
10	41.10	45.2	08B1-10	10	17	25	26	.12	08B2-10	10	19	32	28	.18	08B3-10	12	19	46	28	.25
11	45.07	48.7	08B1-11	10	20	25	29	.15	08B2-11	12	21	35	32	.24	08B3-11	16	21	50	32	.31
12	49.07	53.0	08B1-12	10	22	28	33	.21	08B2-12	12	24	35	35	.30	08B3-12	16	24	50	35	.39
13	53.06	57.4	08B1-13	10	25	28	37	.26	08B2-13	12	26	35	38	.36	08B3-13	16	26	50	38	.49
14	57.07	61.8	08B1-14	10	27	28	41	.32	08B2-14	12	28	35	42	.44	08B3-14	16	28	50	42	.60
15	61.09	65.5	08B1-15	10	30	28	45	.39	08B2-15	12	31	35	46	.52	08B3-15	16	31	50	46	.72
16	65.10	69.5	08B1-16	12	34	28	50	.46	08B2-16	14	34	35	50	.63	08B3-16	16	34	50	50	.85
17	69.11	73.6	08B1-17	12	35	28	52	.51	08B1-17	14	36	35	54	.74	08B3-17	16	36	50	54	.99
18	73.14	77.8	08B1-18	12	37	28	56	.59	08B2-18	14	38	35	58	.85	08B3-18	16	38	50	58	1.14
19	77.16	81.7	08B1-19	12	40	28	60	.67	08B2-19	14	41	35	62	.97	08B3-19	16	41	50	62	1.30
20	81.19	85.8	08B1-20	12	43	28	64	.76	08B2-20	14	44	35	66	1.10	08B3-20	16	44	50	66	1.47
21	85.22	89.7	08B1-21	14	45	28	68	.84	08B2-21	16	46	40	70	1.29	08B3-21	20	46	55	70	1.75
22	89.24	93.8	08B1-22	14	46	28	70	.91	08B2-22	16	46	40	70	1.38	08B3-22	20	46	55	70	1.88
23	93.27	98.2	08B1-23	14	46	28	70	.94	08B2-23	16	46	40	70	1.46	08B3-23	20	46	55	70	2.03
24	97.29	101.8	08B1-24	14	46	28	70	.97	08B2-24	16	50	40	75	1.64	08B3-24	20	50	55	75	2.27
25	101.33	105.8	08B1-25	14	46	28	70	1.00	08B2-25	16	54	40	80	1.83	08B3-25	20	54	55	80	2.52
26	105.36	110.0	08B1-26	16	46	30	70	1.09	08B2-26	20	57	40	85	1.99	08B3-26	20	57	55	85	2.79
27	109.40	114.0	08B1-27	16	46	30	70	1.12	08B2-27	20	57	40	85	2.09	08B3-27	20	57	55	85	2.96
28	113.42	118.0	08B1-28	16	46	30	70	1.16	08B2-28	20	60	40	90	2.30	08B3-28	20	60	55	90	3.25
29	117.46	122.0	08B1-29	16	54	30	80	1.41	08B2-29	20	63	40	95	2.52	08B3-29	20	63	55	95	3.55
30	121.50	126.1	08B1-30	16	54	30	80	1.45	08B2-30	20	67	40	100	2.76	08B3-30	20	67	55	100	3.87
31	125.54	130.2	08B1-31	16	60	30	90	1.74	08B2-31	20	67	40	100	2.88	08B3-31	20	74	55	110	4.33
32	129.56	134.3	08B1-32	16	60	30	90	1.78	08B2-32	20	67	40	100	3.00	08B3-32	20	74	55	110	4.54
33	133.60	138.4	08B1-33	16	60	30	90	1.83	08B2-33	20	67	40	100	3.13	08B3-33	20	74	55	110	4.75
34	137.64	142.6	08B1-34	16	60	30	90	1.87	08B2-34	20	67	40	100	3.26	08B3-34	20	74	55	110	4.87
35	141.68	146.7	08B1-35	16	60	30	90	1.92	08B2-35	20	67	40	100	3.40	08B3-35	20	74	55	110	5.20
36	145.72	151.0	08B1-36	20	60	35	90	2.18	08B2-36	20	67	40	100	3.55	08B3-36	25	80	55	120	5.64
37	149.76	154.6	08B1-37	20	60	35	90	2.23	08B2-37	20	67	40	100	3.69	08B3-37	25	80	55	120	5.89
38	153.80	158.6	08B1-38	20	60	35	90	2.28	08B2-38	20	67	40	100	3.84	08B3-38	25	80	55	120	6.14
39	157.83	162.7	08B1-39	20	60	35	90	2.33	08B2-39	20	67	40	100	4.00	08B3-39	25	80	55	120	6.39
40	161.87	166.8	08B1-40	20	60	35	90	2.38	08B2-40	20	67	40	100	4.16	08B3-40	25	80	55	120	6.66
42	169.94	175.4	08B1-42	20	60	40	*90	2.74	08B2-42	20	74	50	*110	5.46	08B3-42	25	74	60	*110	7.29
45	182.06	188.0	08B1-45	20	60	40	*90	2.93	08B2-45	20	74	50	*110	6.01	08B3-45	25	74	60	*110	8.20
48	194.18	200.3	08B1-48	20	60	40	*90	3.14	08B2-48	20	74	50	*110	6.60	08B3-48	25	74	60	*110	9.17
50	202.26	208.3	08B1-50	20	60	40	*90	3.27	08B2-50	20	74	50	*110	7.00	08B3-50	25	74	60	*110	9.83
57	230.54	236.4	08B1-57	20	60	40	*90	3.80	08B2-57	25	74	50	*110	8.48	08B3-57	25	74	60	*110	12.41
60	242.66	248.6	08B1-60	20	60	40	*90	4.05	08B2-60	25	74	50	*110	9.21	08B3-60	25	74	60	*110	13.62
Cast Iron Wheels																				
57	230.54	236.4	08B1-57	19	42	40	70	2.40	08B2-57	23	54	50	90	4.40	08B3-57	23	60	60	100	6.70
76	307.32	313.3	08B1-76	23	48	40	80	4.10	08B2-76	23	60	56	100	6.40	08B3-76	23	60	60	100	8.20
95	384.11	390.1	08B1-95	23	48	45	80	5.40	08B2-95	23	60	56	100	8.80	08B3-95	23	72	67	120	12.80
114	460.91	466.9	08B1-114	23	54	45	90	7.10	08B2-114	23	60	63	100	10.20	08B3-114	23	72	67	120	16.50

All dimensions in mm.

†Min. toleranced bore which can be machined in sprocket.

Steel Pinions 8 to 40 tooth minimum U.T.S. 600N/mm² - Above 40T - 410N/mm²

Stock Sprockets can be reworked to customers bore and keyway requirements, on 48 hour service.

Steel pinions 8 to 40 tooth can be supplied with teeth induction hardened to 45Rc.

*Sprockets with an asterisk on hub Ø may be of fabricated construction.

Standard Sprockets for 5/8" Pitch British Standard Chains Type 10B

Conforming to ISO Std 606

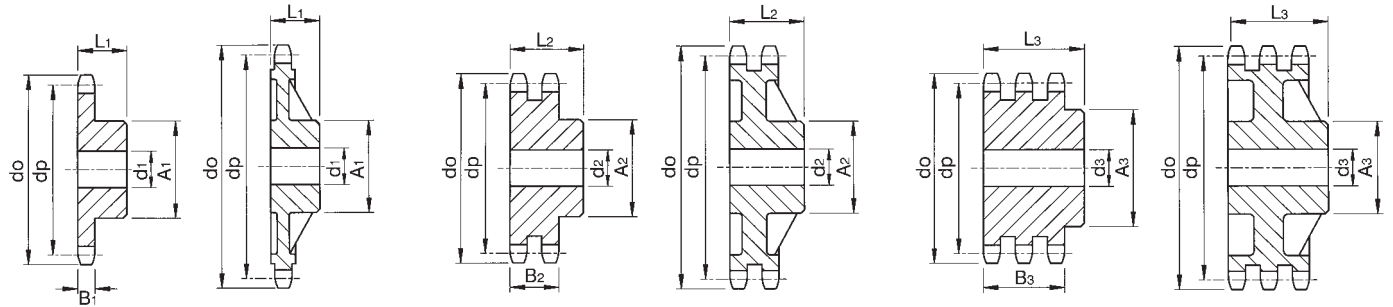

Steel Pinion Cast Iron Wheel Steel Pinion Cast Iron Wheel Steel Pinion Cast Iron Wheel

Simplex Sprockets

Chain No. 10B-1
Pitch 15.875mm
Roller Dia. 10.16mm
Inside Width 9.52mm
Overall Width 20.8mm
Tooth Width B₁ 9.1mm

Duplex Sprockets

Chain No. 10B-2
Pitch 15.875mm
Roller Dia. 10.16mm
Inside Width 9.52mm
Overall Width 37.6mm
Tooth Width B₂ 25.5mm

Triplex Sprockets

Chain No. 10B-3
Pitch 15.875mm
Roller Dia. 10.16mm
Inside Width 9.52mm
Overall Width 54.1mm
Tooth Width B₃ 42.1mm

No. Teeth Z	Pitch Circle Ø dp	Outside Ø do	Simplex Sprocket					Duplex Sprocket					Triplex Sprocket							
			Cat. No.	Min. † Bore d ₁	Max. Bore d ₁	L.T.B. L ₁	Hub Ø A ₁	App. Weight kg	Cat. No.	Min. † Bore d ₂	Max. Bore d ₂	L.T.B. L ₂	Hub Ø A ₂	App. Weight kg	Cat. No.	Min. † Bore d ₃	Max. Bore d ₃	L.T.B. L ₃	Hub Ø A ₃	App. Weight kg
Steel Pinions																				
8	41.48	47.0	10B1-08	10	16	25	25	.12	10B2-08	12	16	40	25	.19	10B3-08	12	16	55	25	.27
9	46.42	52.6	10B1-09	10	20	25	30	.17	10B2-09	12	20	40	30	.27	10B3-09	12	20	55	30	.38
10	51.37	57.5	10B1-10	10	24	25	35	.22	10B2-10	12	24	40	35	.36	10B3-10	16	24	55	35	.47
11	56.34	63.0	10B1-11	12	25	30	37	.29	10B2-11	14	26	40	39	.43	10B3-11	16	26	55	39	.61
12	61.34	68.0	10B1-12	12	28	30	42	.38	10B2-12	14	29	40	44	.55	10B3-12	16	29	55	44	.78
13	66.32	73.0	10B1-13	12	31	30	47	.47	10B2-13	14	33	40	49	.68	10B3-13	16	33	55	49	.95
14	71.34	78.0	10B1-14	12	35	30	52	.56	10B2-14	14	36	40	54	.82	10B3-14	16	36	55	54	1.15
15	76.36	83.0	10B1-15	12	38	30	57	.67	10B2-15	14	39	40	59	.97	10B3-15	16	39	55	59	1.37
16	81.37	88.0	10B1-16	14	40	30	60	.76	10B2-16	16	43	45	64	1.26	10B3-16	16	43	60	64	1.72
17	86.39	93.0	10B1-17	14	40	30	60	.80	10B2-17	16	46	45	69	1.46	10B3-17	16	46	60	69	1.98
18	91.42	98.3	10B1-18	14	46	30	70	1.02	10B2-18	16	49	45	74	1.67	10B3-18	16	49	60	74	2.27
19	96.45	103.3	10B1-19	14	46	30	70	1.07	10B2-19	16	53	45	79	1.90	10B3-19	16	53	60	79	2.58
20	101.49	108.4	10B1-20	14	50	30	75	1.21	10B2-20	16	56	45	84	2.14	10B3-20	16	56	60	84	2.90
21	106.52	113.4	10B1-21	16	50	30	75	1.25	10B2-21	16	57	45	85	2.27	10B3-21	20	57	60	85	3.12
22	111.55	118.0	10B1-22	16	54	30	80	1.40	10B2-22	16	60	45	90	2.54	10B3-22	20	60	60	90	3.48
23	116.58	123.4	10B1-23	16	54	30	80	1.46	10B2-23	16	63	45	95	2.82	10B3-23	20	63	60	95	3.85
24	121.62	128.3	10B1-24	16	54	30	80	1.53	10B2-24	16	67	45	100	3.11	10B3-24	20	67	60	100	4.25
25	126.66	134.0	10B1-25	16	54	30	80	1.59	10B2-25	16	70	45	105	3.42	10B3-25	20	70	60	105	4.66
26	131.70	139.0	10B1-26	20	57	35	85	1.82	10B2-26	20	74	45	110	3.74	10B3-26	20	74	60	110	5.10
27	136.75	144.0	10B1-27	20	57	35	85	1.89	10B2-27	20	74	45	110	3.94	10B3-27	20	74	60	110	5.43
28	141.78	148.7	10B1-28	20	60	35	90	2.24	10B2-28	20	77	45	115	4.28	10B3-28	20	77	60	115	5.89
29	146.83	153.8	10B1-29	20	60	35	90	2.31	10B2-29	20	77	45	115	4.49	10B3-29	20	77	60	115	6.24
30	151.87	158.8	10B1-30	20	60	35	90	2.39	10B2-30	20	80	45	120	4.86	10B3-30	20	80	60	120	6.74
31	156.92	163.9	10B1-31	20	63	35	95	2.62	10B2-31	20	80	45	*120	5.09	10B3-31	20	80	60	*120	7.12
32	161.95	168.9	10B1-32	20	63	35	95	2.71	10B2-32	20	80	45	*120	5.33	10B3-32	20	80	60	*120	7.51
33	167.00	174.5	10B1-33	20	63	35	95	2.79	10B2-33	20	80	45	*120	5.58	10B3-33	20	80	60	*120	7.92
34	172.05	179.0	10B1-34	20	63	35	95	2.88	10B2-34	20	80	45	*120	5.83	10B3-34	20	80	60	*120	8.34
35	177.10	184.1	10B1-35	20	63	35	95	2.98	10B2-35	20	80	45	*120	6.10	10B3-35	20	80	60	*120	8.78
36	182.15	189.1	10B1-36	20	67	35	100	3.23	10B2-36	20	80	45	*120	6.37	10B3-36	25	80	60	*120	9.14
37	187.20	194.2	10B1-37	20	67	35	100	3.33	10B2-37	20	80	45	*120	6.65	10B3-37	25	80	60	*120	9.60
38	192.24	199.2	10B1-38	20	67	35	100	3.43	10B2-38	20	80	45	*120	6.93	10B3-38	25	80	60	*120	10.10
39	197.29	204.2	10B1-39	20	67	35	100	3.53	10B2-39	20	80	45	*120	7.23	10B3-39	25	80	60	*120	10.60
40	202.34	209.3	10B1-40	20	67	35	100	3.64	10B2-40	20	80	45	*120	7.53	10B3-40	25	80	60	*120	11.10
42	212.43	219.9	10B1-42	20	67	40	*100	4.23	10B2-42	20	87	50	*130	9.01	10B3-42	25	87	60	*130	12.40
45	227.58	235.0	10B1-45	20	67	40	*100	4.59	10B2-45	20	87	50	*130	10.03	10B3-45	25	87	60	*130	14.07
48	242.73	250.2	10B1-48	20	67	40	*100	4.99	10B2-48	25	87	50	*130	11.06	10B3-48	25	87	60	*130	15.87
50	252.82	260.3	10B1-50	20	67	40	*100	5.26	10B2-50	25	87	50	*130	11.82	10B3-50	25	87	60	*130	17.13
57	288.18	296.0	10B1-57	25	67	40	*100	6.27	10B2-57	25	87	50	*130	14.79	10B3-57	25	87	60	*130	22.00
60	303.33	310.8	10B1-60	25	67	50	*100	7.33	10B2-60	25	87	63	*130	17.46	10B3-60	25	87	67	*130	24.95
Cast Iron Wheels																				
57	288.18	296.0	10B1-57	23	54	45	90	4.30	10B2-57	29	60	56	100	7.50	10B3-57	31	60	63	100	9.30
76	384.15	392.1	10B1-76	23	54	50	90	6.50	10B2-76	29	60	63	100	9.30	10B3-76	34	66	67	110	14.20
95	480.14	488.5	10B1-96	23	60	56	100	9.20	10B2-95	29	66	63	110	10.50	10B3-95	34	75	70	125	18.50
114	576.13	584.1	10B1-114	23	60	56	100	14.00	10B2-114	29	75	70	125	17.00	10B3-114	34	75	80	125	26.00

All dimensions in mm.

†Min. tolerated bore which can be machined in sprocket.

Steel Pinions 8 to 35 tooth minimum U.T.S. 600N/mm² - Above 35T - 410N/mm²

Stock Sprockets can be reworked to customers bore and keyway requirements, on 48 hour service.

Steel pinions (other than fabricated types) 8 to 35 tooth can be supplied with teeth induction hardened to 45Rc.

*Sprockets with an asterisk on hub Ø may be of fabricated construction.

Standard Sprockets for 3/4" Pitch British Standard Chains Type 12B



Conforming to ISO Std. 606

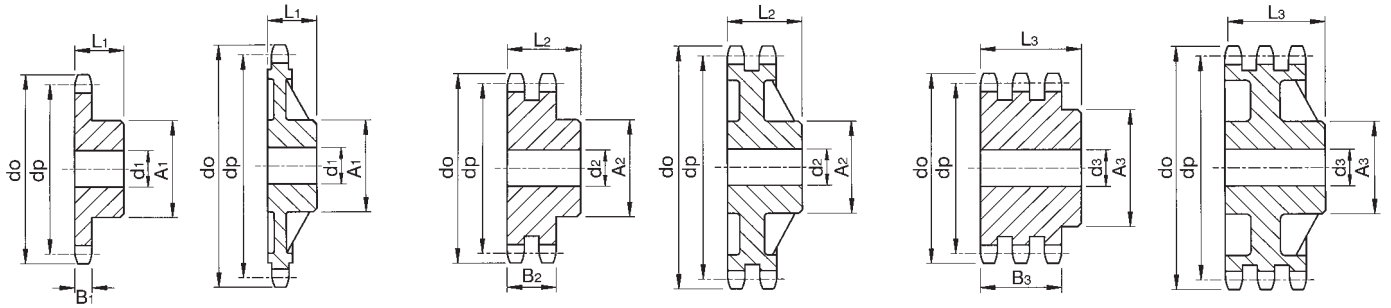

Steel Pinion Cast Iron Wheel Steel Pinion Cast Iron Wheel Steel Pinion Cast Iron Wheel

Simplex Sprockets

Chain No. 12B-1
Pitch 19.05mm
Roller Dia. 12.07mm
Inside Width 11.68mm
Overall Width 24.5mm
Tooth Width B₁ 11.1mm

Duplex Sprockets

Chain No. 12B-2
Pitch 19.05mm
Roller Dia. 12.07mm
Inside Width 11.68mm
Overall Width 44.0mm
Tooth Width B₂ 30.3mm

Triplex Sprockets

Chain No. 12B-3
Pitch 19.05mm
Roller Dia. 12.07mm
Inside Width 11.68mm
Overall Width 63.4mm
Tooth Width B₃ 49.8mm

No. Teeth Z	Pitch Circle Ø dp	Outside Ø do	Simplex Sprocket					Duplex Sprocket					Triplex Sprocket							
			Cat. No.	min. † bore d ₁	max. bore d ₁	L.T.B. L ₁	Hub dia. A ₁	Wt. kg	Cat. No.	min. † bore d ₂	max. bore d ₂	L.T.B. L ₂	Hub dia. A ₂	Wt. kg	Cat. No.	min. † bore d ₃	max. bore d ₃	L.T.B. L ₃	Hub dia. A ₃	Wt. kg
Steel Pinions																				
8	49.78	57.6	12B1-08	12	20	30	31	.21	12B2-08	12	20	45	31	.31	12B3-08	16	20	65	31	.45
9	55.70	62.0	12B1-09	12	25	30	37	.30	12B2-09	12	25	45	37	.44	12B3-09	16	25	65	37	.64
10	61.64	69.0	12B1-10	12	28	30	42	.38	12B2-10	12	28	45	42	.59	12B3-10	16	28	65	42	.87
11	67.61	75.0	12B1-11	14	31	35	46	.51	12B2-11	16	31	50	47	.77	12B3-11	20	31	70	47	1.10
12	73.61	81.5	12B1-12	14	35	35	52	.65	12B2-12	16	35	50	53	.98	12B3-12	20	35	70	53	1.39
13	79.59	87.5	12B1-13	14	38	35	58	.80	12B2-13	16	39	50	59	1.21	12B3-13	20	39	70	59	1.72
14	85.61	93.6	12B1-14	14	43	35	64	.97	12B2-14	16	43	50	65	1.46	12B3-14	20	43	70	65	2.08
15	91.63	99.8	12B1-15	14	46	35	70	1.16	12B2-15	16	47	50	71	1.74	12B3-15	20	47	70	71	2.47
16	97.65	105.5	12B1-16	16	50	35	75	1.34	12B2-16	20	51	50	77	2.04	12B3-16	20	51	70	77	2.80
17	103.67	111.5	12B1-17	16	54	35	80	1.53	12B2-17	20	56	50	83	2.36	12B3-17	20	56	70	83	3.25
18	109.71	118.0	12B1-18	16	54	35	80	1.61	12B2-18	20	59	50	89	2.70	12B3-18	20	59	70	89	3.74
19	115.75	124.2	12B1-19	16	54	35	80	1.70	12B2-19	20	63	50	95	3.07	12B3-19	20	63	70	95	4.25
20	121.78	129.7	12B1-20	16	54	35	80	1.79	12B2-20	20	67	50	100	3.44	12B3-20	20	67	70	100	4.78
21	127.82	136.0	12B1-21	20	60	40	90	2.34	12B2-21	20	67	50	100	3.70	12B3-21	20	67	70	100	5.20
22	133.86	141.8	12B1-22	20	60	40	90	2.44	12B2-22	20	67	50	100	3.97	12B3-22	20	67	70	100	5.65
23	139.90	149.0	12B1-23	20	60	40	90	2.55	12B2-23	20	74	50	110	4.51	12B3-23	20	74	70	110	6.38
24	145.94	153.9	12B1-24	20	60	40	90	2.66	12B2-24	20	74	50	110	4.81	12B3-24	20	74	70	110	6.87
25	152.00	160.0	12B1-25	20	60	40	90	2.77	12B2-25	20	80	50	120	5.41	12B3-25	20	80	70	120	7.67
26	158.04	165.9	12B1-26	20	63	40	95	3.06	12B2-26	20	80	50	120	5.74	12B3-26	20	80	70	120	8.21
27	164.09	172.3	12B1-27	20	63	40	95	3.19	12B2-27	20	80	50	120	6.08	12B3-27	20	80	70	120	8.77
28	170.13	178.0	12B1-28	20	63	40	95	3.32	12B2-28	20	80	50	120	6.44	12B3-28	20	80	70	120	9.36
29	176.19	184.1	12B1-29	20	63	40	95	3.45	12B2-29	20	80	50	120	6.81	12B3-29	20	80	70	120	9.96
30	182.25	190.5	12B1-30	20	63	40	95	3.59	12B2-30	20	80	50	120	7.19	12B3-30	20	80	70	120	10.6
31	188.31	196.3	12B1-31	20	67	40	100	3.73	12B2-31	20	80	50	*120	7.59	12B3-31	25	87	70	*130	11.6
32	194.35	203.3	12B1-32	20	67	40	100	3.88	12B2-32	20	80	50	*120	8.00	12B3-32	25	87	70	*130	12.3
33	200.40	209.3	12B1-33	20	67	40	100	4.04	12B2-33	20	80	50	*120	8.42	12B3-33	25	87	70	*130	13.0
34	206.46	214.6	12B1-34	20	67	40	100	4.20	12B2-34	20	80	50	*120	8.86	12B3-34	25	87	70	*130	13.7
35	212.52	221.0	12B1-35	20	67	40	100	4.36	12B2-35	20	80	50	*120	9.32	12B3-35	25	87	70	*130	14.4
36	218.58	226.8	12B1-36	25	67	40	100	4.65	12B2-36	25	80	50	*120	9.7	12B3-36	25	87	70	*130	15.2
37	224.64	232.9	12B1-37	25	67	40	100	4.82	12B2-37	25	80	50	*120	10.2	12B3-37	25	87	70	*130	16.0
38	230.69	239.0	12B1-38	25	67	40	100	5.00	12B2-38	25	80	50	*120	10.7	12B3-38	25	87	70	*130	16.8
39	236.75	245.1	12B1-39	25	67	40	100	5.19	12B2-39	25	80	50	*120	11.2	12B3-39	25	87	70	*130	17.6
40	242.81	251.3	12B1-40	25	67	40	100	5.37	12B2-40	25	80	50	*120	11.8	12B3-40	25	87	70	*130	18.5
42	254.92	264.5	12B1-42	25	74	56	*110	7.42	12B2-42	25	94	63	*140	15.1	12B3-42	25	94	70	*140	20.7
45	273.09	282.5	12B1-45	25	74	56	*110	8.06	12B2-45	25	94	63	*140	16.9	12B3-45	25	94	70	*140	23.6
48	291.27	300.1	12B1-48	25	74	56	*110	8.72	12B2-48	25	94	63	*140	18.7	12B3-48	25	94	70	*140	26.6
50	303.39	312.3	12B1-50	25	74	56	*110	9.21	12B2-50	25	94	63	*140	20.0	12B3-50	25	94	70	*140	28.8
57	345.81	355.4	12B1-57	25	74	56	*110	11.10	12B2-57	25	94	63	*140	25.2	12B3-57	30	94	70	*140	37.0
60	363.99	373.0	12B1-60	25	74	56	*110	11.94	12B2-60	25	94	63	*140	27.5	12B3-60	30	94	70	*140	40.8
Cast Iron Wheels																				
57	345.81	354.0	12B1-57	29	60	56	100	6.7	12B2-57	29	72	63	120	12.0	12B3-57	39	84	70	140	16.5
76	460.98	469.9	12B1-76	29	60	56	100	10.3	12B2-76	29	80	63	135	17.0	12B3-76	39	96	75	160	24.0
95	576.17	585.1	12B1-95	29	60	65	100	14.2	12B2-95	29	80	70	135	21.0	12B3-95	39	102	82	170	32.0
114	691.36	700.6	12B1-114	29	60	65	100	23.3	12B2-114	44	80	70	135	30.5	12B3-114	49	102	82	170	46.0

All dimensions in mm.

†Min. toleranced bore which can be machined in sprocket.

Steel Pinions 8 to 30 tooth minimum U.T.S. 600N/mm² - Above 30T - 410N/mm²

Stock Sprockets can be reworked to customers bore and keyway requirements, on 48 hour service.

Steel pinions (other than fabricated types) 8 to 30 tooth can be supplied with teeth induction hardened to 45Rc.

*Sprockets with an asterisk on hub Ø may be of fabricated construction.

Standard Sprockets for 1" Pitch British Standard Chains Type 16B

Conforming to ISO Std 606

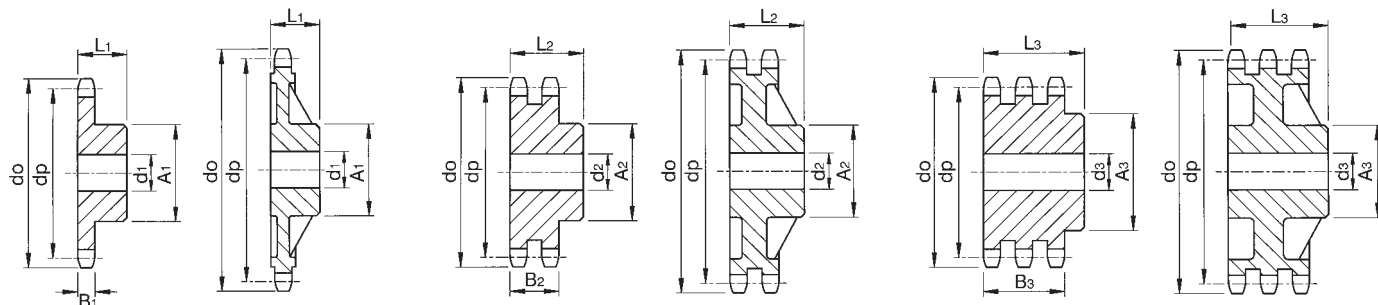

Steel Pinion

Cast Iron Wheel

Steel Pinion

Cast Iron Wheel

Steel Pinion

Cast Iron Wheel

Simplex Sprockets

Chain No. 16B-1
Pitch 25.4mm
Roller Dia. 15.88mm
Inside Width 17.02mm
Overall Width 38.7mm
Tooth Width B₁ 16.2mm

Duplex Sprockets

Chain No. 16B-2
Pitch 25.4mm
Roller Dia. 15.88mm
Inside Width 17.02mm
Overall Width 70.7mm
Tooth Width B₂ 47.7mm

Triplex Sprockets

Chain No. 16B-3
Pitch 25.4mm
Roller Dia. 15.88mm
Inside Width 17.02mm
Overall Width 102.5mm
Tooth Width B₃ 79.6mm

No. Teeth Z	Pitch Circle Ø dp	Outside Ø do	Simplex Sprocket						Duplex Sprocket						Triplex Sprocket					
			Cat. No.	Min. † Bore d ₁	Max. Bore d ₁	L.T.B. L ₁	Hub Ø A ₁	App. Weight kg	Cat. No.	Min. † Bore d ₂	Max. Bore d ₂	L.T.B. L ₂	Hub Ø A ₂	App. Weight kg	Cat. No.	Min. † Bore d ₃	Max. Bore d ₃	L.T.B. L ₃	Hub Ø A ₃	App. Weight kg
Steel Pinions																				
8	66.37	77.0	16B1-08	16	28	35	42	.47	16B2-08	16	28	65	42	.81	16B3-08	20	28	95	42	1.18
9	74.27	85.0	16B1-09	16	34	35	50	.65	16B2-09	16	34	65	50	1.15	16B3-09	20	34	95	50	1.68
10	82.19	93.0	16B1-10	16	36	35	55	.82	16B2-10	16	37	65	56	1.52	16B3-10	20	37	95	56	2.23
11	90.14	99.5	16B1-11	16	40	40	61	1.06	16B2-11	20	43	70	64	2.08	16B3-11	25	43	100	64	2.85
12	98.14	109.0	16B1-12	16	46	40	69	1.34	16B2-12	20	47	70	72	2.60	16B3-12	25	47	100	72	3.61
13	106.12	117.0	16B1-13	16	52	40	78	1.68	16B2-13	20	54	70	80	3.19	16B3-13	25	54	100	80	4.45
14	114.15	125.0	16B1-14	16	56	40	84	2.03	16B2-14	20	58	70	88	3.83	16B3-14	25	58	100	88	5.36
15	122.17	133.0	16B1-15	16	61	40	92	2.41	16B2-15	20	64	70	96	4.52	16B3-15	25	64	100	96	6.36
16	130.20	141.0	16B1-16	20	67	45	100	3.12	16B2-16	25	69	70	104	5.17	16B3-16	30	69	100	104	7.27
17	138.22	149.0	16B1-17	20	67	45	100	3.31	16B2-17	25	75	70	112	5.98	16B3-17	30	75	100	112	8.43
18	146.28	157.0	16B1-18	20	67	45	100	3.52	16B2-18	25	80	70	120	6.84	16B3-18	30	80	100	120	9.67
19	154.33	165.2	16B1-19	20	67	45	100	3.74	16B2-19	25	85	70	128	7.76	16B3-19	30	85	100	128	11.0
20	162.38	173.2	16B1-20	20	67	45	100	3.97	16B2-20	25	87	70	130	8.52	16B3-20	30	87	100	130	12.2
21	170.43	181.2	16B1-21	20	74	50	110	4.89	16B2-21	25	87	70	*130	9.2	16B3-21	30	87	100	*130	13.4
22	178.48	189.3	16B1-22	20	74	50	110	5.14	16B2-22	25	87	70	*130	10.0	16B3-22	30	87	100	*130	14.7
23	186.53	197.5	16B1-23	20	74	50	110	5.41	16B2-23	25	87	70	*130	10.8	16B3-23	30	87	100	*130	16.0
24	194.59	205.5	16B1-24	20	74	50	110	5.69	16B2-24	25	87	70	*130	11.7	16B3-24	30	87	100	*130	17.4
25	202.66	213.5	16B1-25	20	74	50	110	5.99	16B2-25	25	87	70	*130	12.5	16B3-25	30	87	100	*130	18.8
26	210.72	221.6	16B1-26	20	80	50	120	6.78	16B2-26	25	87	70	*130	13.5	16B3-26	30	87	100	*130	20.4
27	218.79	229.6	16B1-27	20	80	50	120	7.10	16B2-27	25	87	70	*130	14.4	16B3-27	30	87	100	*130	21.9
28	226.85	237.7	16B1-28	20	80	50	120	7.43	16B2-28	25	87	70	*130	15.4	16B3-28	30	87	100	*130	23.6
29	234.92	245.8	16B1-29	20	80	50	120	7.78	16B2-29	25	87	70	*130	16.4	16B3-29	30	87	100	*130	25.3
30	243.00	254.0	16B1-30	20	80	50	120	8.13	16B2-30	25	87	70	*130	17.5	16B3-30	30	87	100	*130	27.1
31	251.08	262.0	16B1-31	25	80	50	*120	8.50	16B2-31	25	94	70	*140	19.0	16B3-31	30	94	100	*140	29.3
32	259.13	270.0	16B1-32	25	80	50	*120	8.88	16B2-32	25	94	70	*140	20.1	16B3-32	30	94	100	*140	31.2
33	267.21	278.5	16B1-33	25	80	50	*120	9.28	16B2-33	25	94	70	*140	21.3	16B3-33	30	94	100	*140	33.1
34	275.28	287.0	16B1-34	25	80	50	*120	9.68	16B2-34	25	94	70	*140	22.5	16B3-34	30	94	100	*140	35.2
35	283.36	296.2	16B1-35	25	80	50	*120	10.10	16B2-35	25	94	70	*140	23.8	16B3-35	30	94	100	*140	37.3
36	291.44	304.6	16B1-36	25	80	50	*120	10.5	16B2-36	25	94	70	*140	25.1	16B3-36	30	94	100	*140	39.4
37	299.51	312.6	16B1-37	25	80	50	*120	11.0	16B2-37	25	94	70	*140	26.4	16B3-37	30	94	100	*140	41.6
38	307.59	320.7	16B1-38	25	80	50	*120	11.5	16B2-38	25	94	70	*140	27.8	16B3-38	30	94	100	*140	43.9
39	315.67	328.8	16B1-39	25	80	50	*120	11.9	16B2-39	25	94	70	*140	29.2	16B3-39	30	94	100	*140	46.3
40	323.75	336.9	16B1-40	25	80	50	*120	12.4	16B2-40	25	94	70	*140	30.7	16B3-40	30	94	100	*140	48.7
42	339.89	353.0	16B1-42	25	94	70	*125	17.4	16B2-42	25	100	80	*150	35.6	16B3-42	30	107	100	*160	54.7
45	364.12	377.1	16B1-45	25	94	70	*125	19.0	16B2-45	25	100	80	*150	40.4	16B3-45	30	107	100	*160	62.7
48	388.36	401.3	16B1-48	25	94	70	*125	20.8	16B2-48	30	100	80	*150	45.5	16B3-48	30	107	100	*160	71.3
50	404.52	417.4	16B1-50	25	94	70	*125	22.0	16B2-50	30	100	80	*150	49.1	16B3-50	30	107	100	*160	77.3
57	461.08	474.0	16B1-57	30	94	70	*125	26.7	16B2-57	30	107	90	*160	65.2	16B3-57	40	120	110	*180	102.9
60	485.33	498.3	16B1-60	30	94	80	*140	30.1	16B2-60	40	107	90	*160	71.4	16B3-60	40	120	110	*180	113.8
Cast Iron Wheels																				
57	461.08	474.0	16B1-57	34	75	70	125	13.0	16B2-57	39	96	90	160	20.5	16B3-57	44	100	100	165	42.0
76	614.64	627.0	16B1-76	34	84	80	140	25.3	16B2-76	39	105	95	175	44.0	16B3-76	44	120	110	200	63.0
95	768.22	781.0	16B1-95	39	84	80	140	36.0	16B2-95	44	105	95	175	56.0	16B3-95	49	120	110	200	88.0
114	921.81	934.0	16B1-114	39	90	80	150	46.5	16B2-114	44	105	95	175	61.0	16B3-114	49	120	115	200	90.0

All dimensions in mm.

Steel Pinions 8 to 21 tooth minimum U.T.S. 600N/mm² - Above 21T - 410N/mm²

*Sprockets with an asterisk on hub Ø may be of fabricated construction.

Stock Sprockets can be reworked to customers bore and keyway requirements, on 48 hour service.

Steel pinions (other than fabricated types) 8 to 21 tooth can be supplied with teeth induction hardened to 45Rc.

†Min. toleranced bore which can be machined in sprocket.

Standard Sprockets for 1 1/4" Pitch British Standard Chains Type 20B

Conforming to ISO Std 606

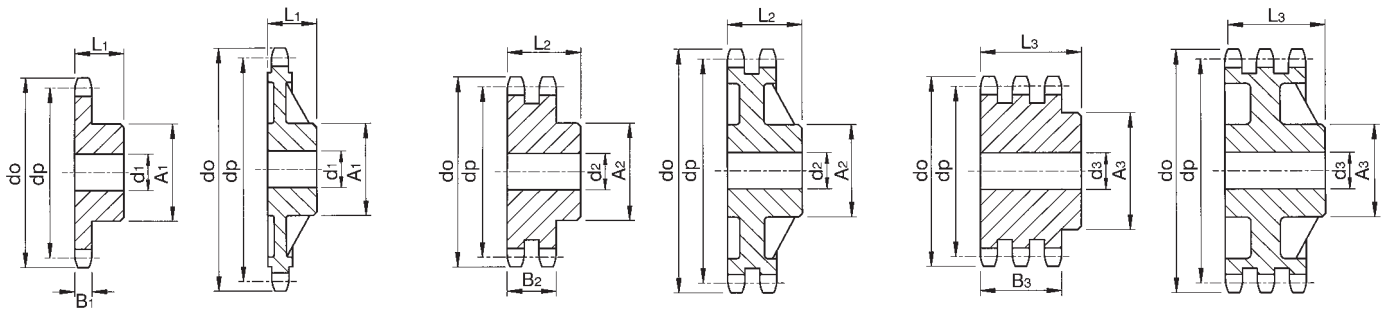

Steel Pinion Cast Iron Wheel Steel Pinion Cast Iron Wheel Steel Pinion Cast Iron Wheel

Simplex Sprockets

Chain No. 20B-1
Pitch 31.75mm
Roller Dia. 19.05mm
Inside Width 19.56mm
Overall Width 44.1mm
Tooth Width B₁ 18.5mm

Duplex Sprockets

Chain No. 20B-2
Pitch 31.75mm
Roller Dia. 19.05mm
Inside Width 19.56mm
Overall Width 80.5mm
Tooth Width B₂ 54.6mm

Triplex Sprockets

Chain No. 20B-3
Pitch 31.75mm
Roller Dia. 19.05mm
Inside Width 19.56mm
Overall Width 117.1mm
Tooth Width B₃ 91.0mm

No. Teeth Z	Pitch Circle Ø dp	Outside Ø do	Simplex Sprocket						Duplex Sprocket						Triplex Sprocket					
			Cat. No.	Min. † Bore d ₁	Max. Bore d ₁	L.T.B. L ₁	Hub Ø A ₁	App. Weight kg	Cat. No.	Min. † Bore d ₂	Max. Bore d ₂	L.T.B. L ₂	Hub Ø A ₂	App. Weight kg	Cat. No.	Min. † Bore d ₃	Max. Bore d ₃	L.T.B. L ₃	Hub Ø A ₃	App. Weight kg
Steel Pinions																				
8	82.96	98.1	20B1-08	20	35	40	53	.85	20B2-08	20	35	75	53	1.57	20B3-08	25	35	110	53	2.14
9	92.84	108.0	20B1-09	20	42	40	63	1.18	20B2-09	20	42	75	63	2.19	20B3-09	25	42	110	63	3.04
10	102.74	117.9	20B1-10	20	46	40	70	1.50	20B2-10	20	46	75	70	2.84	20B3-10	25	46	110	70	4.02
11	112.68	127.8	20B1-11	20	51	45	77	2.02	20B2-11	25	54	80	80	3.71	20B3-11	30	54	115	80	5.17
12	122.68	137.8	20B1-12	20	58	45	88	2.57	20B2-12	25	60	80	90	4.65	20B3-12	30	60	115	90	6.53
13	132.65	147.8	20B1-13	20	65	45	98	3.14	20B2-13	25	67	80	100	5.69	20B3-13	30	67	115	100	8.03
14	142.68	157.8	20B1-14	20	72	45	108	3.77	20B2-14	25	74	80	110	6.83	20B3-14	30	74	115	110	9.68
15	152.72	167.9	20B1-15	20	78	45	118	4.45	20B2-15	25	80	80	120	8.07	20B3-15	30	80	115	120	11.5
16	162.75	177.9	20B1-16	25	80	50	120	5.22	20B2-16	30	80	80	120	8.88	20B3-16	30	80	115	120	13.1
17	172.78	187.9	20B1-17	25	80	50	120	5.57	20B2-17	30	80	80	120	9.90	20B3-17	30	80	115	120	14.7
18	182.85	198.0	20B1-18	25	80	50	120	5.95	20B2-18	30	80	80	*120	11.0	20B3-18	30	80	115	*120	16.5
19	192.91	208.1	20B1-19	25	80	50	120	6.35	20B2-19	30	80	80	*120	12.2	20B3-19	30	80	115	*120	18.4
20	202.98	218.1	20B1-20	25	80	50	120	6.77	20B2-20	30	80	80	*120	13.4	20B3-20	30	80	115	*120	20.5
21	213.04	228.2	20B1-21	30	94	55	140	8.73	20B2-21	30	94	80	*140	15.5	20B3-21	30	94	115	*140	23.4
22	223.11	238.2	20B1-22	30	94	55	140	9.20	20B2-22	30	94	80	*140	16.9	20B3-22	30	94	115	*140	25.6
23	233.17	248.3	20B1-23	30	94	55	140	9.68	20B2-23	30	94	80	*140	18.3	20B3-23	30	94	115	*140	28.0
24	243.23	258.4	20B1-24	30	94	55	140	10.2	20B2-24	30	94	80	*140	19.8	20B3-24	30	94	115	*140	30.5
25	253.33	268.5	20B1-25	30	94	55	140	10.8	20B2-25	30	94	80	*140	21.4	20B3-25	30	94	115	*140	33.1
26	263.40	278.6	20B1-26	30	100	55	*150	12.0	20B2-26	30	100	80	*150	23.4	20B3-26	30	100	115	*150	36.2
27	273.49	288.6	20B1-27	30	100	55	*150	12.6	20B2-27	30	100	80	*150	25.1	20B3-27	30	100	115	*150	39.0
28	283.56	298.7	20B1-28	30	100	55	*150	13.2	20B2-28	30	100	80	*150	26.9	20B3-28	30	100	115	*150	42.0
29	293.65	308.8	20B1-29	30	100	55	*150	13.8	20B2-29	30	100	80	*150	28.8	20B3-29	30	100	115	*150	45.0
30	303.75	318.9	20B1-30	30	100	55	*150	14.4	20B2-30	30	100	80	*150	30.7	20B3-30	30	100	115	*150	48.2
31	313.85	329.0	20B1-31	30	100	55	*150	15.1	20B2-31	30	100	80	*150	32.6	20B3-31	30	100	115	*150	51.5
32	323.91	339.1	20B1-32	30	100	55	*150	15.8	20B2-32	30	100	80	*150	34.7	20B3-32	30	100	115	*150	54.9
33	334.01	349.2	20B1-33	30	100	55	*150	16.5	20B2-33	30	100	80	*150	36.8	20B3-33	30	100	115	*150	58.4
34	344.10	359.3	20B1-34	30	100	55	*150	17.2	20B2-34	30	100	80	*150	39.0	20B3-34	30	100	115	*150	62.0
35	354.20	369.4	20B1-35	30	100	55	*150	18.0	20B2-35	30	100	80	*150	41.2	20B3-35	30	100	115	*150	65.8
36	364.30	379.5	20B1-36	30	100	55	*150	18.8	20B2-36	30	100	80	*150	43.6	20B3-36	30	100	115	*150	69.6
37	374.39	389.5	20B1-37	30	100	55	*150	19.6	20B2-37	30	100	80	*150	45.9	20B3-37	30	100	115	*150	73.6
38	384.49	399.6	20B1-38	30	100	55	*150	20.4	20B2-38	30	100	80	*150	48.4	20B3-38	30	100	115	*150	77.7
39	394.59	409.7	20B1-39	30	100	55	*150	21.3	20B2-39	30	100	80	*150	50.9	20B3-39	30	100	115	*150	86.2
40	404.69	419.8	20B1-40	30	100	55	*150	22.2	20B2-40	30	100	80	*150	53.5	20B3-40	30	100	115	*150	86.2
42	424.86	440.0	20B1-42	30	100	70	*150	26.8	20B2-42	30	107	90	*160	61.5	20B3-42	40	120	110	*180	95.8
45	455.15	470.3	20B1-45	30	100	70	*150	29.7	20B2-45	30	107	90	*160	70.1	20B3-45	40	120	110	*180	110.2
48	485.45	500.6	20B1-48	30	100	70	*150	33.0	20B2-48	30	107	90	*160	79.4	20B3-48	40	120	110	*180	125.6
50	505.65	520.8	20B1-50	30	100	70	*150	35.2	20B2-50	30	107	90	*160	85.9	20B3-50	40	120	110	*180	136.4
57	576.35	591.5	20B1-57	30	100	80	*150	45.2	20B2-57	40	107	100	*160	112.0	20B3-57	40	120	125	*180	180.8
60	606.66	621.8	20B1-60	30	100	80	*150	49.2	20B2-60	40	107	100	*160	123.8	20B3-60	40	120	125	*180	200.3
Cast Iron Wheels																				
57	576.35	591.5	20B1-57	39	80	80	135	25.6	20B2-57	49	96	100	160	45.0	20B3-57	62	108	125	180	65.0
76	768.30	783.5	20B1-76	49	84	90	140	39.0	20B2-76	55	108	100	180	65.0	20B3-76	63	120	140	200	85.0

All dimensions in mm.

†Min. tolerated bore which can be machined in sprocket.

Steel Pinions 8 to 21 tooth minimum U.T.S. 600N/mm² - Above 21T - 410N/mm²

Stock Sprockets can be reworked to customers bore and keyway requirements, on 48 hour service.

*Sprockets with asterisk on hub Ø may be of fabricated construction.

Steel pinions (other than fabricated types) 8 to 21 tooth can be supplied with teeth induction hardened to 45Rc.

Tel +44(0) 121 360 0155

Fax +44(0) 121 325 1079

Email sales@crossmorse.com

Standard Sprockets for 1 1/2" Pitch British Standard Chains Type 24B

Conforming to ISO Std 606



Email sales@crossmorse.com Tel +44(0) 121 325 1079 Fax +44(0) 121 360 0155

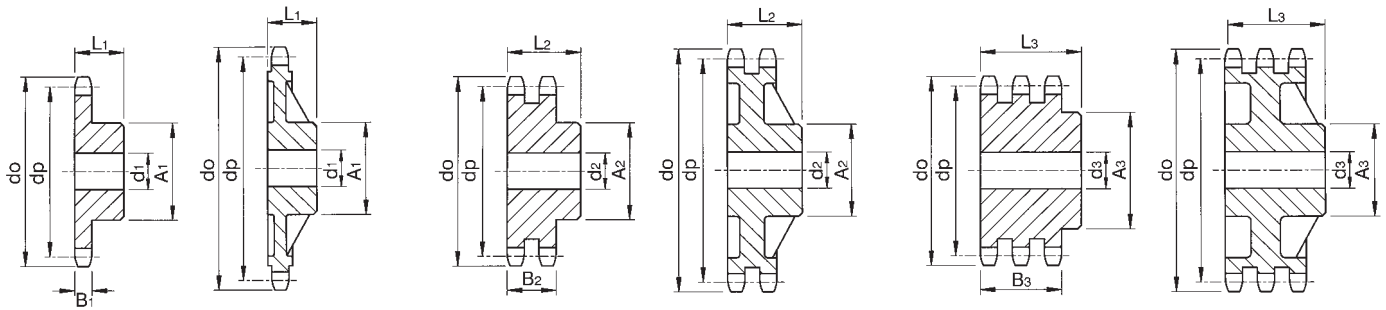

Steel Pinion Cast Iron Wheel Steel Pinion Cast Iron Wheel Steel Pinion Cast Iron Wheel

Simplex Sprockets

Chain No. 24B-1
Pitch 38.1mm
Roller Dia. 25.4mm
Inside Width 25.4mm
Overall Width 56.9mm
Tooth Width B₁ 24.1mm

Duplex Sprockets

Chain No. 24B-2
Pitch 38.1mm
Roller Dia. 25.4mm
Inside Width 25.4mm
Overall Width 105.0mm
Tooth Width B₂ 72.0mm

Triplex Sprockets

Chain No. 24B-3
Pitch 38.1mm
Roller Dia. 25.4mm
Inside Width 25.4mm
Overall Width 153.0mm
Tooth Width B₃ 120.3mm

No. Teeth Z	Pitch Circle Ø dp	Outside Ø do	Simplex Sprocket					Duplex Sprocket					Triplex Sprocket							
			Cat. No.	Min. † Bore d ₁	Max. Bore d ₁	L.T.B. L ₁	Hub Ø A ₁	App. Weight kg	Cat. No.	Min. † Bore d ₂	Max. Bore d ₂	L.T.B. L ₂	Hub Ø A ₂	App. Weight kg	Cat. No.	Min. † Bore d ₃	Max. Bore d ₃	L.T.B. L ₃	Hub Ø A ₃	App. Weight kg
Steel Pinions																				
8	99.55	115.0	24B1-08	20	38	45	58	1.35	24B2-08	25	38	95	58	2.66	24B3-08	25	38	140	58	3.95
9	111.40	126.4	24B1-08	20	46	45	70	1.88	24B2-09	25	46	95	70	3.75	24B3-09	25	46	140	70	5.56
10	123.29	138.0	24B1-10	20	54	45	80	2.42	24B2-10	25	54	95	80	4.96	24B3-10	25	54	140	80	7.38
11	135.21	150.0	24B1-11	25	60	50	90	3.22	24B2-11	25	60	100	90	6.56	24B3-11	30	60	150	90	9.66
12	147.22	162.0	24B1-12	25	68	50	102	4.04	24B2-12	25	68	100	102	8.22	24B3-12	30	68	150	102	12.2
13	159.18	174.2	24B1-13	25	76	50	114	4.95	24B2-13	25	76	100	114	10.1	24B3-13	30	76	150	114	15.0
14	171.22	186.2	24B1-14	25	85	50	128	6.03	24B2-14	25	85	100	128	12.2	24B3-14	30	85	150	128	18.1
15	183.26	198.2	24B1-15	25	94	50	140	7.13	24B2-15	25	94	100	140	14.4	24B3-15	30	88	150	132	21.4
16	195.30	210.3	24B1-16	25	94	55	*140	8.31	24B2-16	30	94	100	*140	16.0	24B3-16	30	92	150	136	24.9
17	207.34	222.3	24B1-17	25	94	55	*140	8.96	24B2-17	30	100	100	*150	18.4	24B3-17	30	94	150	*140	28.1
18	219.42	234.3	24B1-18	25	94	55	*140	9.64	24B2-18	30	100	100	*150	21.0	24B3-18	30	100	150	*150	32.0
19	231.49	246.5	24B1-19	25	94	55	*140	10.4	24B2-19	30	107	100	*160	23.2	24B3-19	30	107	150	*160	35.6
20	243.57	258.6	24B1-20	25	94	55	*140	11.2	24B2-20	30	107	100	*160	25.4	24B3-20	30	107	150	*160	39.4
21	255.65	270.6	24B1-21	30	100	60	*150	13.2	24B2-21	30	107	100	*160	27.9	24B3-21	40	107	150	*160	42.8
22	267.73	282.7	24B1-22	30	100	60	*150	14.1	24B2-22	30	107	100	*160	30.4	24B3-22	40	107	150	*160	47.0
23	279.80	294.8	24B1-23	30	100	60	*150	15.0	24B2-23	30	107	100	*160	33.1	24B3-23	40	107	150	*160	51.5
24	291.88	306.8	24B1-24	30	100	60	*150	15.9	24B2-24	30	107	100	*160	35.9	24B3-24	40	107	150	*160	56.1
25	304.00	319.0	24B1-25	30	100	60	*150	16.9	24B2-25	30	107	100	*160	38.8	24B3-25	40	107	150	*160	61.0
26	316.08	331.0	24B1-26	30	107	60	*160	18.6	24B2-26	30	107	100	*160	41.9	24B3-26	40	107	150	*160	66.1
27	328.19	343.2	24B1-27	30	107	60	*160	19.7	24B2-27	30	107	100	*160	45.1	24B3-27	40	107	150	*160	71.4
28	340.27	355.2	24B1-28	30	107	60	*160	20.8	24B2-28	30	107	100	*160	48.4	24B3-28	40	107	150	*160	77.0
29	352.38	367.3	24B1-29	30	107	60	*160	21.9	24B2-29	30	107	100	*160	51.8	24B3-29	40	107	150	*160	82.7
30	364.50	379.5	24B1-30	30	107	60	*160	23.1	24B2-30	30	107	100	*160	55.4	24B3-30	40	107	150	*160	88.7
31	376.62	391.6	24B1-31	30	107	60	*160	24.2	24B2-31	40	107	100	*160	58.7						
32	388.69	403.7	24B1-32	30	107	60	*160	25.5	24B2-32	40	107	100	*160	62.5	24B3-32	40	107	150	*160	101.3
33	400.81	415.8	24B1-33	30	107	60	*160	26.8	24B2-33	40	107	100	*160	66.5	24B3-33	40	107	150	*160	107.9
34	412.93	427.8	24B1-34	30	107	60	*160	28.2	24B2-34	40	107	100	*160	70.6	24B3-34	40	107	150	*160	114.8
35	425.04	440.0	24B1-35	30	107	60	*160	29.6	24B2-35	40	107	100	*160	74.8	24B3-35	40	107	150	*160	121.8
36	437.16	452.0	24B1-36	30	107	60	*160	31.0	24B2-36	40	107	100	*160	79.2	24B3-36	40	107	150	*160	129.1
37	449.27	464.2	24B1-37	30	107	60	*160	32.5	24B2-37	40	107	100	*160	83.7						
38	461.39	476.2	24B1-38	30	107	60	*160	34.0	24B2-38	40	107	100	*160	88.3	24B3-38	40	107	150	*160	144.3
39	473.50	488.5	24B1-39	30	107	60	*160	35.6	24B2-39	40	107	100	*160	93.0						
40	485.62	500.6	24B1-40	30	107	60	*160	37.2	24B2-40	10	107	100	*160	97.9	24B3-40	40	107	150	*160	160.4
42	509.83	524.7	24B1-42	30	107	90	*160	46.0	24B2-42	40	120	100	*180	108.6	24B3-42	40	135	150	*200	178.6
45	546.19	561.2	24B1-45	30	107	90	*160	51.5	24B2-45	40	120	100	*180	124.9	24B3-45	40	135	150	*200	205.6
48	582.54	597.4	24B1-48	30	107	90	*160	57.4	24B2-48	40	120	100	*180	142.2	24B3-48	40	135	150	*200	234.5
50	606.78	621.7	24B1-50	30	107	90	*160	61.6	24B2-50	40	120	100	*180	154.5	24B3-50	40	135	150	*200	255.0
57	691.62	706.5	24B1-57	30	107	100	*160	79.0	24B2-57	40	135	110	*200	205.1	24B3-57	40	135	150	*220	335.8
60	727.99	742.8	24B1-60	30	107	100	*160	85.5	24B2-60	40	135	110	*200	227.1	24B3-60	40	135	150	*220	371.5
Cast Iron Wheels																				
57	691.62	706.5	24B1-57	44	96	100	160	42.5	24B2-57	54	120	110	200	73.0	24B3-57	62	120	150	200	117.0
76	921.96	936.9	24B1-76	44	102	100	170	66.5	24B2-76	54	132	120	220	127.0	24B3-76	69	150	150	250	180.0
95	1152.33	1167.3	24B1-95	50	120	125	200	82.0	24B2-95	55	132	140	220	163.0						

All dimensions in mm.

Steel Pinions 8 to 21 tooth minimum U.T.S. 600 N/mm² - Above 21T - 410N/mm²

*Sprockets with an asterisk on hub Ø may be of fabricated construction.

Stock Sprockets can be reworked to customers bore and keyway requirements, on 48 hour service.

Steel pinions (other than fabricated types) 8 to 21 tooth can be supplied with teeth induction hardened to 45Rc.

Standard Sprockets for 1³/₄" Pitch British Standard Chains Type 28B

Conforming to ISO Std 606

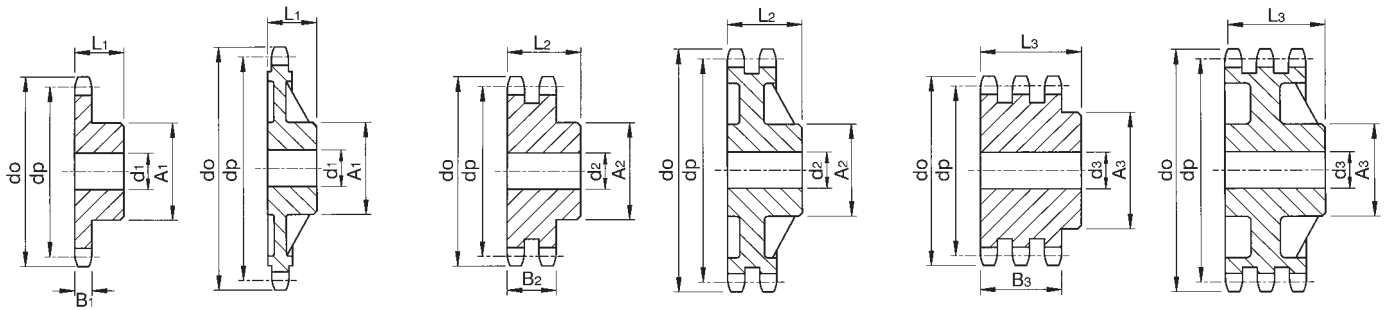

Steel Pinion Cast Iron Wheel Steel Pinion Cast Iron Wheel Steel Pinion Cast Iron Wheel

Simplex Sprockets

Chain No. 28B-1
Pitch 44.45mm
Roller Dia. 27.94mm
Inside Width 30.99mm
Overall Width 71.3mm
Tooth Width B₁ 29.4mm

Duplex Sprockets

Chain No. 28B-2
Pitch 44.45mm
Roller Dia. 127.94mm
Inside Width 30.99mm
Overall Width 130.3mm
Tooth Width B₂ 88.4mm

Triplex Sprockets

Chain No. 28B-3
Pitch 44.45mm
Roller Dia. 27.94mm
Inside Width 30.99mm
Overall Width 189.9mm
Tooth Width B₃ 148.0mm

No. Teeth Z	Pitch Circle Ø dp	Outside Ø do	Simplex Sprocket						Duplex Sprocket						Triplex Sprocket					
			Cat. No.	Min. † Bore d ₁	Max. Bore d ₁	L.T.B. L ₁	Hub Ø A ₁	App. Weight kg	Cat. No.	Min. † Bore d ₂	Max. Bore d ₂	L.T.B. L ₂	Hub Ø A ₂	App. Weight kg	Cat. No.	Min. † Bore d ₃	Max. Bore d ₃	L.T.B. L ₃	Hub Ø A ₃	App. Weight kg
8	116.15	132.0	28B1-08	25	48	70	74	2.8	28B2-08	30	48	120	74	4.7	28B3-08	30	48	180	74	7.0
9	129.96	148.4	28B1-09	25	59	70	88	3.9	28B2-09	30	59	120	88	6.6	28B3-09	30	59	180	88	9.8
10	143.85	162.3	28B1-10	25	67	70	100	5.1	28B2-10	30	67	120	100	8.7	28B3-10	30	67	180	100	13.0
11	157.77	176.3	28B1-11	25	75	70	112	6.4	28B2-11	30	75	120	112	11.1	28B3-11	30	75	180	120	16.6
12	171.74	189.5	28B1-12	25	83	70	125	7.9	28B2-12	30	83	120	125	13.8	28B3-12	30	83	180	125	20.7
13	185.75	204.2	28B1-13	25	83	70	*125	9.1	28B2-13	30	83	120	*125	16.4	28B3-13	30	83	180	*125	24.8
14	199.76	218.2	28B1-14	25	87	70	*130	10.3	28B2-14	30	87	120	*130	19.2	28B3-14	30	87	180	*130	29.2
15	213.79	232.2	28B1-15	25	95	70	*145	11.9	28B2-15	30	95	120	*145	22.5	28B3-15	30	95	180	*145	34.4
16	227.84	246.3	28B1-16	30	107	75	*160	14.9	28B2-16	30	107	120	*160	26.3	28B3-16	30	107	180	*160	40.2
17	241.91	260.0	28B1-17	30	107	75	*160	16.0	28B2-17	30	107	120	*160	29.5	28B3-17	30	107	180	*160	45.5
18	255.98	274.0	28B1-18	30	107	75	*160	17.1	28B2-18	30	107	120	*160	32.9	28B3-18	30	107	180	*160	51.1
19	270.06	289.0	28B1-19	30	107	75	*160	18.3	28B2-19	30	120	120	*180	37.9	28B3-19	30	120	180	*180	58.5
20	284.15	303.0	28B1-20	30	107	75	*160	19.6	28B2-20	30	120	120	*180	41.7	28B3-20	30	120	180	*180	64.9
21	298.24	317.0	28B1-21	30	114	75	*170	21.8	28B2-21	30	120	120	*180	45.7	28B3-21	40	120	180	*180	70.8
22	312.34	331.0	28B1-22	30	114	75	*170	23.2	28B2-22	30	120	120	*180	50.0	28B3-22	40	120	180	*180	77.9
23	326.44	345.0	28B1-23	30	114	75	*170	24.7	28B2-23	30	120	120	*180	54.5	28B3-23	40	120	180	*180	85.4
24	340.55	359.0	28B1-24	30	114	75	*170	26.2	28B2-24	30	120	120	*180	59.2	28B3-24	40	120	180	*180	93.2
25	354.66	373.0	28B1-25	30	114	75	*170	27.9	28B2-25	30	120	120	*180	64.0	28B3-25	40	120	180	*180	102.0
26	368.77	387.0	28B1-26	30	114	75	*170	29.6	28B2-26	40	120	120	*180	69.2	28B3-26	40	120	180	*180	109.9
27	382.88	401.4	28B1-27	30	114	75	*170	31.3	28B2-27	40	120	120	*180	74.5	28B3-27	40	120	180	*180	118.8
28	397.00	416.0	28B1-28	30	114	75	*170	33.2	28B2-28	40	120	120	*180	80.0	28B3-28	40	120	180	*180	128.1
29	411.12	430.0	28B1-29	30	114	75	*170	35.0	28B2-29	40	120	120	*180	85.8	28B3-29	40	120	180	*180	138.0
30	425.24	444.0	28B1-30	30	114	75	*170	37.0	28B2-30	40	120	120	*180	91.3	28B3-30	40	120	180	*180	148.0
31	439.37	458.0	28B1-31	30	120	75	*180	40.1												
32	453.49	472.0	28B1-32	30	120	75	*180	42.2												
33	467.62	486.0	28B1-33	30	120	75	*180	44.4												
34	481.75	500.0	28B1-34	30	120	75	*180	46.6												
35	495.88	514.0	28B1-35	30	120	75	*180	48.9	28B2-35	40	134	120	*200	126.0	28B3-35	40	134	180	*200	205.0
36	510.01	529.0	28B1-36	30	120	75	*180	51.3												
37	524.14	543.0	28B1-37	30	120	75	*180	53.8												
38	538.27	557.0	28B1-38	30	120	75	*180	56.3	28B2-38	40	134	120	*200	148.5	28B3-38	40	134	180	*200	242.0
39	552.40	571.0	28B1-39	30	120	75	*180	58.9												
40	566.54	585.0	28B1-40	30	120	75	*180	61.6	28B2-40	40	134	120	*200	164.5	28B3-40	40	134	180	*200	270.0
45	637.22	656.0	28B1-45	30	120	90	*180	82.0	28B2-45	40	135	120	*200	210.0	28B3-45	40	135	180	*200	344.0
50	707.91	726.0	28B1-50	40	120	90	*180	98.0	28B2-50	40	135	120	*200	259.0	28B3-50	40	135	180	*200	427.0
57	806.89	825.0	28B1-57	40	125	100	*200	130.0	28B2-57	40	145	120	*220	340.0	28B3-57	40	145	180	*220	560.0

All dimensions in mm.

†Min. tolerated bore which can be machined in sprocket.

Steel Pinions 8 to 21 tooth minimum U.T.S. 600 N/mm² - Above 21T - 410N/mm²

Stock Sprockets can be reworked to customers bore and keyway requirements, on 48 hour service.

*Sprockets with asterisk on hub Ø may be of fabricated construction.

Steel pinions (other than fabricated types) 8 to 21 tooth can be supplied with teeth induction hardened to 45Rc.

Tel +44(0) 121 360 0155

Fax +44(0) 121 325 1079

Email sales@crossmorse.com

Standard Sprockets for 2" Pitch British Standard Chains Type 32B

Conforming to ISO Std 606

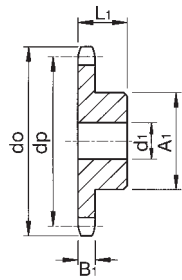

Steel Pinion

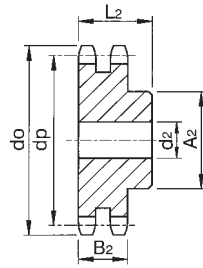

Steel Pinion

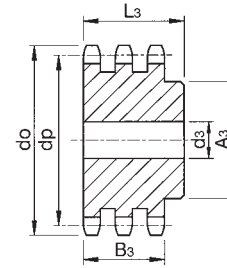

Steel Pinion

Simplex Sprockets

Chain No. 32B-1
Pitch 50.8mm
Roller Dia. 29.21mm
Inside Width 30.99mm
Overall Width 68.6mm
Tooth Width B₁ 29.4mm

Duplex Sprockets

Chain No. 32B-2
Pitch 50.8mm
Roller Dia. 29.21mm
Inside Width 30.99mm
Overall Width 126.8mm
Tooth Width B₂ 87.4mm

Triplex Sprockets

Chain No. 32B-3
Pitch 50.8mm
Roller Dia. 29.21mm
Inside Width 30.99mm
Overall Width 185.0mm
Tooth Width B₃ 146.0mm

No. Teeth Z	Pitch Circle Ø dp	Outside Ø do	Simplex Sprocket						Duplex Sprocket						Triplex Sprocket					
			Cat. No.	Min. † Bore d ₁	Max. Bore d ₁	L.T.B. L ₁	Hub Ø A ₁	App. Weight kg	Cat. No.	Min. † Bore d ₂	Max. Bore d ₂	L.T.B. L ₂	Hub Ø A ₂	App. Weight kg	Cat. No.	Min. † Bore d ₃	Max. Bore d ₃	L.T.B. L ₃	Hub Ø A ₃	App. Weight kg
8	132.69	153.2	32B1-08	30	55	80	82	4.2	32B2-08	30	55	120	82	6.6	32B3-08	30	55	180	82	9.8
9	148.54	169.0	32B1-09	30	58	80	88	5.7	32B2-09	30	58	120	88	9.1	32B3-09	30	58	180	88	13.6
10	164.44	185.0	32B1-10	30	69	80	104	7.6	32B2-10	30	69	120	104	12.0	32B3-10	30	69	180	104	17.9
11	180.34	200.8	32B1-11	30	80	80	*120	9.2	32B2-11	35	80	120	120	14.7	32B3-11	35	80	180	120	22.1
12	196.29	216.8	32B1-12	30	90	80	*133	10.8	32B2-12	35	90	120	*133	17.8	32B3-12	35	90	180	*133	27.1
13	212.29	232.8	32B1-13	30	97	80	*145	12.9	32B2-13	35	97	120	*145	21.6	32B3-13	35	97	180	*145	32.8
14	228.29	248.8	32B1-14	30	103	80	*155	15.0	32B2-14	35	103	120	*155	25.5	32B3-14	35	103	180	*155	38.9
15	244.30	264.8	32B1-15	30	107	80	*160	16.8	32B2-15	35	107	120	*160	29.4	32B3-15	35	107	180	*160	45.2
16	260.40	280.9	32B1-16	30	107	90	*160	19.2	32B2-16	40	107	120	*160	33.0	32B3-16	40	107	180	*160	51.2
17	276.40	296.9	32B1-17	30	114	90	*170	21.9	32B2-17	40	120	120	*180	38.5	32B3-17	40	120	180	*180	59.5
18	292.55	313.0	32B1-18	30	114	90	*170	23.4	32B2-18	40	120	120	*180	42.9	32B3-18	40	120	180	*180	66.9
19	308.66	329.1	32B1-19	30	114	90	*170	25.0	32B2-19	40	134	120	*200	49.2	32B3-19	40	134	180	*200	76.3
20	324.71	345.2	32B1-20	30	120	90	*180	28.0	32B2-20	40	134	120	*200	54.2	32B3-20	40	134	180	*200	84.6
21	340.82	361.3	32B1-21	40	120	90	*180	29.8	32B2-21	40	134	120	*200	59.4	32B3-21	40	134	180	*200	93.3
22	356.98	377.5	32B1-22	40	120	90	*180	31.6	32B2-22	40	134	120	*200	65.0	32B3-22	40	134	180	*200	102.5
23	373.08	393.6	32B1-23	40	120	90	*180	33.6	32B2-23	40	134	120	*200	70.8	32B3-23	40	134	180	*200	112.2
24	389.18	409.7	32B1-24	40	120	90	*180	35.6	32B2-24	40	134	120	*200	76.9	32B3-24	40	134	180	*200	122.4
25	405.33	425.8	32B1-25	40	120	90	*180	37.7	32B2-25	40	134	120	*200	83.3	32B3-25	40	134	180	*200	133.0
26	421.44	441.9	32B1-26	40	120	90	*180	40.0	32B2-26	40	134	120	*200	89.9	32B3-26	40	134	180	*200	144.1
27	437.59	458.1	32B1-27	40	120	90	*180	42.3	32B2-27	40	134	120	*200	96.8	32B3-27	40	134	180	*200	155.6
28	453.69	474.2	32B1-28	40	120	90	*180	44.7	32B2-28	40	134	120	*200	104.0	32B3-28	40	134	180	*200	167.6
29	469.90	490.4	32B1-29	40	120	90	*180	47.2												
30	486.00	506.5	32B1-30	40	120	90	*180	49.7	32B2-30	40	134	120	*200	119.3	32B3-30	40	134	180	*200	193.0
32	581.26	538.8	32B1-32	40	120	90	*180	55.2												
35	566.72	589.5	32B1-35	40	120	90	*180	64.0												
38	615.14	635.5	32B1-38	40	120	90	*180	73.6	32B2-38	40	134	120	*200	176.0	32B3-38	40	134	180	*200	285.0
40	647.49	670.3	32B1-40	40	120	90	*180	80.5												
45	728.25	751.0	32B1-45	40	120	100	*180	112.7	32B2-45	40	140	120	*200	274.0	32B3-45	40	140	180	*200	449.0
50	809.04	831.8	32B1-50	40	120	100	*180	134.9	32B2-50	40	140	120	*200	338.0	32B3-50	40	140	180	*200	557.0
57	922.16	993.4	32B1-57	40	120	100	*180	187.1	32B2-57	40	145	120	*220	476.0	32B3-57	40	165	180	*250	782.0

All dimensions in mm.

Steel Pinions 8 to 21 tooth minimum U.T.S. 600 N/mm² - Above 21T - 410N/mm²

Stock Sprockets can be reworked to customers bore and keyway requirements, on 48 hour service.

*Sprockets with asterisk on hub Ø may be of fabricated construction.

Steel pinions (other than fabricated types) 8 to 21 tooth can be supplied with teeth induction hardened to 45Rc.

†Min. toleranced bore which can be machined in sprocket.

Standard Stainless Steel Sprockets for 3/8" to 1" Pitch British Standard Chains Types 06S1-12 to 10S1-18



Conforming to ISO Std 606

Sprocket Data

A standard stock range of sprockets manufactured from Stainless Steel type ANSI 304L for maximum corrosion resistance. These sprockets are suitable for corrosive environments, including the high temperature and moisture conditions found in many food process and packaging operations, and will also withstand many alkaline and acidic fluids at elevated temperatures.

The sprockets are suitable to use with either stainless steel chains or plated chains, refer page 18.

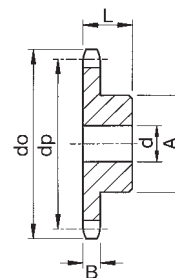

Chain No.	Tooth Width B
06B-1	5.3
08B-1	7.2
10B-1	9.2
ANSI 50	9.2
12B-1	11.2
16B-1	16.2

Cat No.	Pitch	No of Teeth	Pitch Circle Ø dp	Outside Ø do	Min. Bore d	Max. Bore d	L.T.B. L	Hub Ø A	Weight
06S1-12	3/8"	12	36.80	40.00	8.00	16.00	25.00	25.00	0.11
06S1-13		13	39.80	43.00	10.00	19.00	25.00	28.00	0.13
06S1-14		14	42.80	46.30	10.00	20.00	25.00	31.00	0.16
06S1-15		15	45.81	49.30	10.00	23.00	25.00	34.00	0.19
06S1-16		16	48.82	52.30	10.00	25.00	28.00	37.00	0.24
06S1-17		17	51.84	55.30	10.00	27.00	28.00	40.00	0.29
06S1-18		18	54.85	58.30	10.00	29.00	28.00	43.00	0.33
06S1-19		19	57.87	61.30	10.00	30.00	28.00	45.00	0.37
06S1-20		20	60.89	64.30	10.00	31.00	28.00	46.00	0.39
06S1-21		21	63.91	68.00	12.00	32.00	28.00	48.00	0.42
06S1-22		22	66.93	71.00	12.00	34.00	28.00	50.00	0.47
06S1-23		23	69.95	73.50	12.00	35.00	28.00	52.00	0.50
06S1-24	24	72.97	77.00	12.00	36.00	28.00	54.00	0.55	
06S1-25	25	76.00	80.00	12.00	38.00	28.00	57.00	0.61	
06S1-30	30	91.12	94.70	12.00	40.00	28.00	60.00	0.92	
08S1-12	1/2"	12	49.07	53.00	10.00	22.00	28.00	33.00	0.21
08S1-13		13	53.07	57.90	10.00	25.00	28.00	37.00	0.26
08S1-14		14	57.07	61.80	10.00	27.00	28.00	41.00	0.31
08S1-15		15	61.08	65.50	10.00	30.00	28.00	45.00	0.39
08S1-16		16	65.10	69.90	12.00	34.00	28.00	50.00	0.46
08S1-17		17	69.12	73.60	12.00	35.00	28.00	52.00	0.51
08S1-18		18	73.14	78.00	12.00	37.00	28.00	56.00	0.59
08S1-19		19	77.16	81.70	12.00	40.00	28.00	60.00	0.67
08S1-20		20	81.18	86.00	12.00	43.00	28.00	64.00	0.55
08S1-21		21	85.21	90.10	14.00	45.00	28.00	68.00	0.84
08S1-22		22	89.24	93.80	14.00	46.00	28.00	70.00	0.91
08S1-23		23	93.27	98.10	14.00	46.00	28.00	70.00	0.94
08S1-24		24	97.30	101.80	14.00	46.00	28.00	70.00	1.00
08S1-25		25	101.33	105.80	14.00	54.00	28.00	80.00	1.10
08S1-26		26	105.36	110.00	16.00	46.00	28.00	70.00	1.09
08S1-27		27	109.40	114.00	16.00	46.00	30.00	80.00	1.12
08S1-30	30	121.50	126.30	16.00	54.00	30.00	80.00	1.48	
08S1-34	34	137.64	142.60	16.00	63.00	30.00	90.00	1.87	
08S1-38	38	153.79	158.60	20.00	63.00	35.00	90.00	2.00	
08S1-40	40	161.87	166.80	20.00	63.00	35.00	90.00	2.38	
10S1-10	5/8"	10	41.10	57.50	10.00	24.00	25.00	35.00	0.22
10S1-11		11	45.08	63.00	12.00	25.00	30.00	37.00	0.29
10S1-12		12	49.07	68.00	12.00	28.00	30.00	42.00	0.38
10S1-13		13	66.33	73.00	12.00	31.00	30.00	47.00	0.47
10S1-14		14	71.34	78.00	12.00	35.00	30.00	52.00	0.60
10S1-15		15	76.35	83.00	12.00	38.00	30.00	57.00	0.67
10S1-16		16	81.37	88.00	12.00	40.00	30.00	60.00	0.76
10S1-17		17	86.39	93.00	12.00	40.00	30.00	60.00	0.82
10S1-18		18	91.42	98.30	12.00	46.00	30.00	70.00	1.02

Tel +44(0) 121 360 0155

Fax +44(0) 121 325 1079

Email sales@crossmorse.com

Standard Stainless Steel Sprockets for 3/8" to 1" Pitch British Standard Chains Types 10S1-19 to 16S1-30



Conforming to ISO Std 606

Sprocket Data

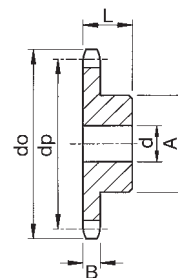

Chain No.	Tooth Width B
06B-1	5.3
08B-1	7.2
10B-1	9.2
ANSI 50	9.2
12B-1	11.2
16B-1	16.2

A standard stock range of sprockets manufactured from Stainless Steel type ANSI 304L for maximum corrosion resistance. These sprockets are suitable for corrosive environments, including the high temperature and moisture conditions found in many food process and packaging operations, and will also withstand many alkaline and acidic fluids at elevated temperatures.

The sprockets are suitable to use with either stainless steel chains or plated chains, refer page 18.

Cat No.	Pitch	No of Teeth	Pitch Circle Ø dp	Outside Ø do	Min. Bore d	Max. Bore d	L.T.B. L	Hub Ø A	Weight
10S1-19	5/8"	19	96.45	103.30	14.00	50.00	30.00	75.00	1.15
10S1-20		20	101.48	108.40	14.00	50.00	30.00	75.00	1.21
10S1-21		21	106.51	113.40	16.00	54.00	30.00	80.00	1.36
10S1-22		22	111.55	118.00	16.00	54.00	30.00	80.00	1.40
10S1-23		23	116.59	123.40	16.00	54.00	30.00	80.00	1.46
10S1-24		24	121.62	128.30	16.00	54.00	30.00	80.00	1.53
10S1-25		25	126.66	134.00	16.00	54.00	30.00	80.00	1.59
10S1-26		26	131.70	139.00	20.00	57.00	35.00	85.00	1.82
10S1-30		30	151.87	158.80	20.00	60.00	35.00	90.00	2.39
10S1-35		35	177.10	184.10	20.00	63.00	35.00	95.00	2.00
12S1-11	3/4"	11	56.35	75.00	14.00	31.00	35.00	46.00	0.54
12S1-12		12	61.34	81.50	14.00	35.00	35.00	52.00	0.70
12S1-13		13	79.60	87.50	16.00	38.00	35.00	58.00	0.80
12S1-14		14	85.61	93.60	14.00	43.00	35.00	64.00	1.00
12S1-15		15	91.63	99.80	16.00	46.00	35.00	70.00	1.16
12S1-16		16	97.65	105.00	16.00	50.00	35.00	75.00	1.34
12S1-17		17	103.67	115.50	16.00	54.00	35.00	80.00	1.53
12S1-18		18	109.70	118.00	16.00	54.00	35.00	80.00	1.61
12S1-19		19	115.74	124.20	16.00	54.00	35.00	80.00	1.70
12S1-20		20	121.78	129.70	16.00	54.00	35.00	80.00	1.79
12S1-21		21	127.82	136.00	20.00	60.00	40.00	90.00	2.34
12S1-22		22	133.86	141.80	20.00	60.00	40.00	90.00	2.40
12S1-23		23	139.90	149.00	20.00	60.00	40.00	90.00	2.55
12S1-24		24	145.95	153.90	20.00	60.00	40.00	90.00	2.74
12S1-25	25	151.99	160.00	20.00	60.00	40.00	90.00	2.77	
12S1-27	27	164.09	144.00	20.00	57.00	35.00	85.00	2.77	
12S1-30	30	182.25	190.50	20.00	63.00	40.00	95.00	3.72	
16S1-12	1"	12	73.60	109.00	16.00	46.00	40.00	69.00	1.34
16S1-13		13	106.14	117.00	16.00	52.00	40.00	78.00	1.68
16S1-14		14	114.15	125.00	16.00	56.00	40.00	84.00	2.03
16S1-15		15	122.17	133.00	16.00	61.00	40.00	92.00	2.41
16S1-16		16	130.20	141.00	19.00	67.00	45.00	100.00	3.12
16S1-17		17	138.23	149.00	20.00	67.00	45.00	100.00	3.31
16S1-18		18	146.27	157.00	20.00	67.00	45.00	100.00	3.52
16S1-19		19	154.32	165.20	20.00	67.00	45.00	100.00	3.74
16S1-20		20	162.37	173.00	20.00	67.00	45.00	100.00	3.97
16S1-21		21	170.42	181.20	20.00	74.00	50.00	100.00	4.89
16S1-22		22	178.48	189.30	20.00	74.00	50.00	110.00	5.14
16S1-23		23	186.54	197.50	20.00	74.00	50.00	110.00	5.62
16S1-24		24	194.60	205.50	20.00	74.00	50.00	110.00	5.90
16S1-25		25	202.66	213.50	20.00	74.00	50.00	110.00	6.18
16S1-30		30	243.00	254.00	20.00	80.00	50.00	120.00	8.13

Original T. D. Cross Sprockets

Refs. H11 and H11A with Double Boss
to suit 1/2" Pitch Chains Types 086 and 08B-1



These sprockets are to original T. D. Cross & Sons dimensions with a small boss on the face side of the sprocket, to act as spacer. All sprockets, now manufactured from medium carbon steel for improved wear life, are suitable for induction hardening.

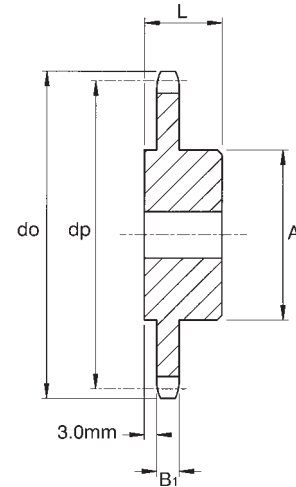

Simplex Sprocket

Sprocket Type	H11	H11A
Chain Ref.	086	08B-1
Chain Size	1/2" x 0.205"	1/2" x 5/16"
Roller Diameter	8.51mm	8.51mm
Tooth Width B ₁	4.7mm	7.2mm

Sprocket Series H11 for 1/2" Pitch Narrow Series Chain Ref. 086

Cat No.	No. Teeth	Pitch Circle Ø dp	Outside Ø do max.	Stock Bore d H8	Max. Bore d max.	Hub dia. A	Length L	App. Weight kg
H11-10	10	41.10	46.3	12.70	18	27.0	25.4	0.11
H11-11	11	45.07	50.3	12.70	18	27.0	25.4	0.14
H11-12	12	49.07	54.4	12.70	24	35.0	25.4	0.18
H11-13	13	53.06	58.2	12.70	24	35.0	25.4	0.24
H11-14	14	57.07	62.3	12.70	27	41.3	25.4	0.29
H11-15	15	61.09	66.3	12.70	31	47.0	25.4	0.36
H11-16	16	65.10	70.4	12.70	31	47.0	25.4	0.41
H11-17	17	69.11	74.5	12.70	36	54.0	25.4	0.47
H11-18	18	73.14	78.3	12.70	36	54.0	25.4	0.52
H11-19	19	77.16	82.3	12.70	36	54.0	25.4	0.53
H11-20	20	81.19	86.4	12.70	36	54.0	25.4	0.56
H11-21	21	85.22	90.5	12.70	46	70.0	25.4	0.59
H11-22	22	89.24	94.5	12.70	46	70.0	25.4	0.62
H11-23	23	93.27	98.6	12.70	46	70.0	25.4	0.65
H11-24	24	97.29	102.6	12.70	46	70.0	25.4	0.68
H11-25	25	101.33	106.5	12.70	46	70.0	25.4	0.72
H11-26	26	105.36	110.5	12.70	46	70.0	25.4	0.76
H11-27	27	109.40	114.6	19.05	46	70.0	31.8	1.03
H11-28	28	113.42	118.6	19.05	46	70.0	31.8	1.06
H11-29	29	117.46	122.7	19.05	46	70.0	31.8	1.22
H11-30	30	121.50	126.8	19.05	46	70.0	31.8	1.30

Sprocket Series H11A for 1/2" Pitch Narrow Series Chain Ref. 08B-1

Cat No.	No. Teeth	Pitch Circle Ø dp	Outside Ø do max.	Stock Bore d H8	Max. Bore d max.	Hub dia. A	Length L	App. Weight kg
H11A-10	10	41.10	46.3	12.70	18	27.0	25.4	0.11
H11A-11	11	45.07	50.3	12.70	18	27.0	25.4	0.14
H11A-12	12	49.07	54.4	12.70	24	35.0	25.4	0.18
H11A-13	13	53.06	58.2	12.70	24	35.0	25.4	0.24
H11A-14	14	57.07	62.3	12.70	27	41.3	25.4	0.29
H11A-15	15	61.09	66.3	12.70	31	47.0	25.4	0.36
H11A-16	16	65.10	70.4	12.70	31	47.0	25.4	0.41
H11A-17	17	69.11	74.5	12.70	36	54.0	25.4	0.47
H11A-18	18	73.14	78.3	12.70	36	54.0	25.4	0.52
H11A-19	19	77.16	82.3	12.70	36	54.0	25.4	0.53
H11A-20	20	81.19	86.4	12.70	36	54.0	25.4	0.56
H11A-21	21	85.22	90.5	12.70	46	70.0	25.4	0.59
H11A-22	22	89.24	94.5	12.70	46	70.0	25.4	0.62
H11A-23	23	93.27	98.6	12.70	46	70.0	25.4	0.65
H11A-24	24	97.29	102.6	12.70	46	70.0	25.4	0.68
H11A-25	25	101.33	106.5	12.70	46	70.0	25.4	0.72
H11A-26	26	105.36	110.5	12.70	46	70.0	25.4	0.76
H11A-27	27	109.40	114.6	19.05	46	70.0	31.8	1.03
H11A-28	28	113.42	118.6	19.05	46	70.0	31.8	1.06
H11A-29	29	117.46	122.7	19.05	46	70.0	31.8	1.22
H11A-30	30	121.50	126.8	19.05	46	70.0	31.8	1.30

All dimensions in mm.
Stock Sprockets can be reworked to customers bore and keyway requirements.

Tel +44(0) 121 360 0155

Fax +44(0) 121 325 1079

Email sales@crossmorse.com

Original T. D. Cross Sprockets

Refs. H11C and H11D with Double Boss
to suit Chain Types 10B-1 ($5/8$ " pitch) and 06B-1 ($3/8$ " pitch)



These sprockets are to original T. D. Cross & Sons dimensions with a small boss on the face side of the sprocket, to act as spacer. All sprockets, now manufactured from medium carbon steel for improved wear life, are suitable for induction hardening.

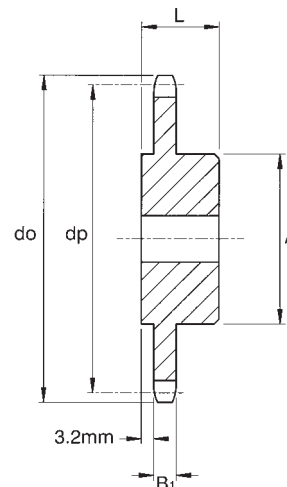

Simplex Sprocket

Sprocket Type	H11C	H11D
Chain Ref.	10B-1	06B-1
Chain Size	$5/8$ " x $3/8$ "	$3/8$ " x $7/32$ "
Roller Diameter	10.16mm	6.35mm
Tooth Width B ₁	9.0mm	5.3mm

Sprocket Series H11C for $5/8$ " Pitch Chain to ISO Ref. 10B-1

Cat No.	No. Teeth	Pitch Circle Ø dp	Outside Ø do max.	Stock Bore d H8	Max. Bore d max.	Hub dia. A	Length L	App. Weight kg
H11C-10	10	51.37	58.9	12.70	23	34.9	25.4	0.22
H11C-11	11	56.34	64.0	12.70	26	38.1	25.4	0.27
H11C-12	12	61.34	68.8	12.70	30	44.5	25.4	0.35
H11C-13	13	66.32	73.9	12.70	31	47.0	25.4	0.44
H11C-14	14	71.34	79.0	12.70	36	54.0	25.4	0.52
H11C-15	15	76.36	83.8	12.70	36	54.0	25.4	0.56
H11C-16	16	81.37	88.9	12.70	36	54.0	25.4	0.60
H11C-17	17	86.39	94.0	12.70	36	54.0	25.4	0.63
H11C-18	18	91.42	99.1	12.70	36	54.0	25.4	0.69
H11C-19	19	96.45	104.2	12.70	46	70.0	25.4	0.74
H11C-20	20	101.49	109.0	12.70	46	70.0	25.4	0.79
H11C-21	21	106.52	114.1	12.70	46	70.0	25.4	0.85
H11C-22	22	111.55	119.2	12.70	46	70.0	25.4	0.91
H11C-23	23	116.58	124.2	19.05	46	70.0	31.8	1.30
H11C-24	24	121.62	129.3	19.05	46	70.0	31.8	1.39
H11C-25	25	126.66	134.4	19.05	46	70.0	31.8	1.43
H11C-26	26	131.70	139.2	25.40	68	102.0	38.1	1.78
H11C-27	27	136.75	144.3	25.40	68	102.0	38.1	2.22
H11C-28	28	141.78	149.4	25.40	68	102.0	38.1	2.73
H11C-29	29	146.83	153.8	25.40	68	102.0	38.1	2.80
H11C-30	30	151.87	158.8	25.40	68	102.0	38.1	2.88

Sprocket Series H11D for $3/8$ " Pitch Chain to ISO Ref. 06B-1

Cat No.	No. Teeth	Pitch Circle Ø dp	Outside Ø do max.	Stock Bore d H8	Max. Bore d max.	Hub dia. A	Length L	App. Weight kg
H11D-09	9	27.85	31.7	9.53	10	15.9	25.4	0.04
H11D-10	10	30.82	34.8	9.53	12	19.0	25.4	0.05
H11D-11	11	33.80	37.9	9.53	14	22.2	25.4	0.07
H11D-12	12	36.80	40.9	9.53	17	25.4	25.4	0.10
H11D-13	13	39.79	43.9	9.53	19	28.6	25.4	0.13
H11D-14	14	42.80	46.7	9.53	21	31.8	25.4	0.17
H11D-15	15	45.81	49.8	9.53	22	33.3	25.4	0.18
H11D-16	16	48.82	52.8	12.70	24	35.0	25.4	0.19
H11D-17	17	51.83	55.9	12.70	24	35.0	25.4	0.20
H11D-18	18	54.85	58.9	12.70	24	35.0	25.4	0.28
H11D-19	19	57.87	62.0	12.70	31	47.0	25.4	0.32
H11D-20	20	60.89	65.0	12.70	31	47.0	25.4	0.33
H11D-21	21	63.91	67.8	12.70	31	47.0	25.4	0.37
H11D-22	22	66.93	70.9	12.70	36	54.0	25.4	0.46
H11D-23	23	69.95	73.9	12.70	36	54.0	25.4	0.48
H11D-24	24	72.97	77.0	12.70	36	54.0	25.4	0.49
H11D-25	25	76.00	80.0	12.70	36	54.0	25.4	0.50
H11D-26	26	79.02	83.1	12.70	36	54.0	25.4	0.52
H11D-27	27	82.05	86.1	12.70	36	54.0	25.4	0.53
H11D-28	28	85.07	89.2	12.70	36	54.0	25.4	0.55
H11D-29	29	88.09	92.2	12.70	36	54.0	25.4	0.57
H11D-30	30	91.12	95.3	12.70	36	54.0	25.4	0.59

All dimensions in mm.
Stock Sprockets can be reworked to customers bore and keyway requirements.

Email sales@crossmorse.com Fax +44(0) 121 325 1079 Tel +44(0) 121 360 0155

Double Simplex Sprockets for $3/8''$ to 1'' Pitch Standard Roller Chains

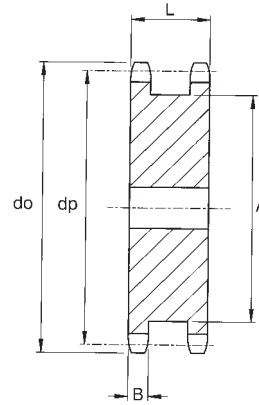

Simplex Sprocket

Chain No.	Tooth Width B
06B-1	5.3
08B-1	7.2
10B-1	9.2
ANSI 50	9.2
12B-1	11.2
16B-1	16.2

Cat. No.	No. of Teeth	Pitch Circle Ø dp	Outside Ø do	Stock Bore d H8	Max Bore † d	Hub Diameter A	Length L	Approx. Weight kg
----------	--------------	-------------------	--------------	-----------------	--------------	----------------	----------	-------------------

For $3/8''$ Pitch Chains to ISO 606 - 06B-1

DS06B1-14	14	42.80	46.3	10	20	31	23.5	0.17
DS06B1-15	15	45.81	49.3	10	23	34	23.5	0.20
DS06B1-16	16	48.82	52.3	10	25	37	23.5	0.23
DS06B1-17	17	51.83	55.3	10	27	40	23.5	0.27
DS06B1-18	18	54.85	58.3	10	29	43	23.5	0.31
DS06B1-19	19	57.87	61.3	10	31	46	23.5	0.35
DS06B1-20	20	60.89	64.3	10	33	48	23.5	0.39
DS06B1-21	21	63.91	68.0	10	35	52	23.5	0.45
DS06B1-23	23	69.95	73.5	10	38	58	23.5	0.55
DS06B1-25	25	76.00	80.0	10	43	64	23.5	0.67

For $1/2''$ Pitch Chains to ISO 606 - 08B-1

DS08B1-12	12	49.07	53.0	12	24	35	31	0.29
DS08B1-13	13	53.06	57.4	12	26	38	31	0.35
DS08B1-14	14	57.07	61.8	12	27	41	31	0.43
DS08B1-15	15	61.09	65.5	12	30	45	31	0.49
DS08B1-16	16	65.10	69.5	12	34	49	31	0.58
DS08B1-17	17	69.11	73.6	12	36	53	31	0.66
DS08B1-18	18	73.14	77.8	12	38	58	31	0.75
DS08B1-19	19	77.16	81.7	12	41	62	31	0.85
DS08B1-20	20	81.19	85.8	12	44	66	31	0.96
DS08B1-21	21	85.22	89.7	18	46	70	31	1.04
DS08B1-23	23	93.27	98.2	18	51	78	31	1.28
DS08B1-25	25	101.33	105.8	18	56	86	31	1.55

For $5/8''$ Pitch Chains to ISO 606 - 10A-1 (ANSI 50)* and 10B-1

DS10B1-12	12	61.34	68.0	19	30	45	36.5	0.55
DS10B1-13	13	66.32	73.0	19	34	50	36.5	0.66
DS10B1-14	14	71.34	78.0	19	36	55	36.5	0.80
DS10B1-15	15	76.36	83.0	19	40	60	36.5	0.94
DS10B1-16	16	81.37	88.0	19	43	65	36.5	1.11
DS10B1-17	17	86.38	93.0	19	46	70	36.5	1.25
DS10B1-18	18	91.42	98.3	19	50	75	36.5	1.43
DS10B1-19	19	96.45	103.3	19	54	80	36.5	1.62
DS10B1-20	20	101.49	108.4	19	58	85	36.5	1.81
DS10B1-21	21	106.52	113.4	19	60	90	36.5	2.02
DS10B1-23	23	116.58	123.4	19	65	100	36.5	2.47
DS10B1-25	25	126.66	134.0	19	72	110	36.5	2.97

For $3/4''$ Pitch Chains to ISO 606 - 12B-1

DS12B1-12	12	73.61	81.5	24	35	53	45	1.05
DS12B1-13	13	79.59	87.5	24	39	59	45	1.24
DS12B1-14	14	85.61	93.6	24	43	65	45	1.46
DS12B1-15	15	91.63	99.8	24	47	71	45	1.63
DS12B1-16	16	97.65	105.5	24	51	77	45	1.94
DS12B1-17	17	103.67	111.5	24	56	83	45	2.18
DS12B1-18	18	109.71	118.0	24	59	89	45	2.50
DS12B1-19	19	115.75	124.2	24	63	95	45	2.83
DS12B1-20	20	121.78	129.7	24	66	101	45	3.17
DS12B1-21	21	127.82	136.0	24	70	107	45	3.54
DS12B1-23	23	139.90	149.0	24	78	119	45	4.33
DS12B1-25	25	152.00	160.0	24	85	131	45	5.20

For 1'' Pitch Chains to ISO 606 - 16B-1

DS16B1-12	12	98.14	109.0	25	47	72	63.5	2.50
DS16B1-13	13	106.12	117.0	25	54	81	63.5	3.13
DS16B1-14	14	114.15	125.0	25	58	88	63.5	3.75
DS16B1-15	15	122.17	133.0	25	64	97	63.5	4.36
DS16B1-16	16	130.20	141.0	25	69	104	63.5	5.00
DS16B1-17	17	138.22	149.0	25	75	113	63.5	5.78
DS16B1-18	18	146.28	157.0	25	80	121	63.5	6.56
DS16B1-19	19	154.33	165.2	25	86	129	63.5	7.40
DS16B1-20	20	162.38	173.2	25	90	137	63.5	8.29
DS16B1-21	21	170.43	181.2	25	96	145	63.5	9.21
DS16B1-23	23	186.53	197.5	25	108	161	63.5	11.18
DS16B1-25	25	202.66	213.5	25	116	177	63.5	13.38

†Maximum bore sizes listed allow for B.S. Standard Key. For Plain Bore, sizes can be increased approximately 20%.

Note: Stock sprockets can be supplied finished bored, keyed and/or setscrewed to customers requirements.

Above range of Double Simplex Sprockets are stock items. Other sizes can be manufactured to order on short lead time.

*When sprockets used for ANSI 50 chain, chains must be mounted with connecting links facing away from sprocket.

Tel +44(0) 121 360 0155

Fax +44(0) 121 325 1079

Email sales@crossmorse.com

Double Simplex Taper Bore Sprockets for $\frac{3}{8}$ " to 1" Pitch Roller Chains

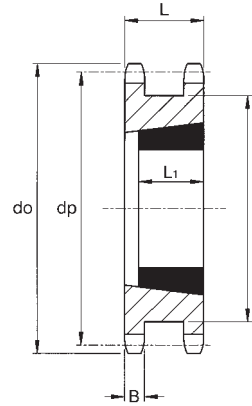

Simplex Sprocket

Chain No.	Tooth Width B	Sprocket Width L
06B-1	5.3	23.5
08B-1	7.2	31.0
10B-1	9.2	36.5
ANSI 50	9.2	36.5
12B-1	11.2	45.0
16B-1	16.2	63.5

Cat. No.	No. Teeth	Pitch Circle Ø dp	Outside Ø do	Taper Bore Bush		Hub Diameter A	Length L ₁	Approx. Weight kg
				Bush No.	Max. Bore			

For $\frac{3}{8}$ " Pitch Chains to ISO 606 - 06B-1

DS06B1-18TB	18	54.85	58.3	1008	25	43	22.2	0.19
DS06B1-19TB	19	57.87	61.3	1008	25	46	22.2	0.23
DS06B1-20TB	20	60.89	64.3	1108	28	48	22.2	0.25
DS06B1-21TB	21	63.91	68.0	1108	28	52	22.2	0.31
DS06B1-23TB	23	69.95	73.5	1108	28	58	22.2	0.41
DS06B1-25TB	25	76.00	80.0	1108	28	64	22.2	0.53

For $\frac{1}{2}$ " Pitch Chains to ISO 606 - 08B-1

DS08B1-15TB	15	61.09	65.5	1008	25	45	22.2	0.36
DS08B1-16TB	16	65.10	69.5	1108	28	49	22.2	0.43
DS08B1-17TB	17	69.11	73.6	1108	28	53	22.2	0.39
DS08B1-18TB	18	73.14	77.8	1210	32	58	25.4	0.48
DS08B1-19TB	19	77.16	81.7	1210	32	62	25.4	0.58
DS08B1-20TB	20	81.19	85.8	1210	32	66	25.4	0.65
DS08B1-21TB	21	85.22	89.7	1610	42	70	25.4	0.63
DS08B1-23TB	23	93.27	98.2	1610	42	78	25.4	0.87
DS08B1-25TB	25	101.33	105.8	2012	51	86	31.8	0.87

For $\frac{3}{4}$ " Pitch Chains to ISO 606 - 10A-1 (ANSI 50)* and 10B-1

DS10B1-12TB	12	61.34	68.0	1108	28	45	22.2	0.42
DS10B1-13TB	13	66.32	73.0	1108	28	50	22.2	0.53
DS10B1-14TB	14	71.34	78.0	1108	28	55	22.2	0.67
DS10B1-15TB	15	76.36	83.0	1210	32	60	25.4	0.64
DS10B1-16TB	16	81.37	88.0	1210	32	65	25.4	0.81
DS10B1-17TB	17	86.38	93.0	1610	42	70	25.4	0.80
DS10B1-18TB	18	91.42	98.3	1610	42	75	25.4	0.98
DS10B1-19TB	19	96.45	103.3	1610	42	80	25.4	1.17
DS10B1-20TB	20	101.49	108.4	1610	42	85	25.4	1.36
DS10B1-21TB	21	106.52	113.4	2012	51	90	31.8	1.24
DS10B1-23TB	23	116.58	123.4	2012	51	100	31.8	1.69
DS10B1-25TB	25	126.66	134.0	2012	51	110	31.8	2.20

For $\frac{3}{4}$ " Pitch Chains to ISO 606 - 12B-1

DS12B1-13TB	13	79.59	87.5	1210	32	59	25.4	0.94
DS12B1-14TB	14	85.61	93.6	1210	32	65	25.4	1.16
DS12B1-15TB	15	91.63	99.8	1610	42	71	25.4	1.18
DS12B1-16TB	16	97.65	105.5	1610	42	77	25.4	1.49
DS12B1-17TB	17	103.67	111.5	1610	42	83	25.4	1.73
DS12B1-18TB	18	109.71	118.0	2012	51	89	31.8	1.62
DS12B1-19TB	19	115.75	124.2	2012	51	95	31.8	1.95
DS12B1-20TB	20	121.78	129.7	2517	65	101	44.5	1.70
DS12B1-21TB	21	127.82	136.0	2517	65	107	44.5	2.05
DS12B1-23TB	23	139.90	149.0	2517	65	119	44.5	2.85
DS12B1-25TB	25	152.00	160.0	2517	65	131	44.5	3.75

For 1" Pitch Chains to ISO 606 - 16B-1

DS16B1-12TB	12	98.14	109.0	1615	42	72	38.1	1.90
DS16B1-13TB	13	106.12	117.0	1615	42	81	38.1	2.50
DS16B1-14TB	14	114.15	125.0	2012	51	88	31.8	2.50
DS16B1-15TB	15	122.17	133.0	2012	51	97	31.8	3.10
DS16B1-16TB	16	130.20	141.0	2012	51	104	31.8	3.75
DS16B1-17TB	17	138.22	149.0	2517	65	113	44.5	3.90
DS16B1-18TB	18	146.28	157.0	2517	65	121	44.5	4.70
DS16B1-19TB	19	154.33	165.2	2517	65	129	44.5	5.50
DS16B1-20TB	20	162.38	173.2	3020	76	137	50.8	5.15
DS16B1-21TB	21	170.43	181.2	3020	76	145	50.8	6.05
DS16B1-23TB	23	186.53	197.5	3525	90	161	63.5	7.20
DS16B1-25TB	25	202.66	213.5	3525	90	177	63.5	9.40

All dimensions in mm. Details Taper Bore Bushes refer to pp 38/39.

*When sprockets used for ANSI 50 chain, chains must be mounted with connecting links facing away from sprocket.

Email sales@crossmorse.com
 Tel +44(0) 121 360 0155
 Fax +44(0) 121 325 1079

Standard Sprockets for 3/8" & 1/2" Pitch American Standard Chains



Refs ANSI 35, 40 & 41

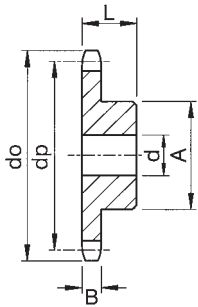

ANSI 35 Chain (ISO Ref 06C)
Pitch 9.525mm
Roller Dia. 5.08mm
Inside Width 4.77mm
Tooth Width B 4.4mm

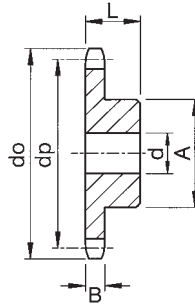

ANSI 40 Chain (ISO Ref 08A-1)
Pitch 12.7mm
Roller Dia. 7.95mm
Inside Width 7.85mm
Tooth Width B 7.4mm

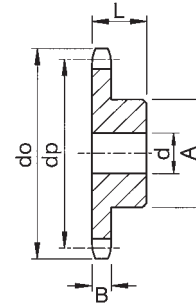

ANSI 41 Chain (ISO Ref 085)
Pitch 12.7mm
Roller Dia. 7.77mm
Inside Width 6.35mm
Tooth Width B 5.9mm

No. Teeth Z	Sprockets for ANSI 35 Chain						Sprockets for ANSI 40 Chain						Sprockets for ANSI 41 Chain					
	Cat No.	min. bore d	max. bore d	L.T.B. L	Hub dia. A	App. Wt. kg	Cat No.	min. bore d	max. bore d	L.T.B. L	Hub dia. A	App. Wt. kg	Cat No.	min. bore d	max. bore d	L.T.B. L	Hub dia. A	App. Wt. kg
Steel Pinions																		
10	35B10	8	13	22	20	.06	40B10	10	17	25	26	.12	41B10	10	17	25	26	.11
11	35B11	8	14	25	22	.08	40B11	10	20	25	29	.15	41B11	10	20	25	29	.14
12	35B12	8	16	25	25	.11	40B12	10	22	28	35	.21	41B12	10	22	28	33	.20
13	35B13	10	19	25	28	.13	40B13	10	25	28	35	.26	41B13	10	25	28	37	.25
14	35B14	10	20	25	31	.16	40B14	10	27	28	35	.32	41B14	10	27	28	41	.31
15	35B15	10	23	25	34	.19	40B15	10	30	28	46	.39	41B15	10	30	28	45	.37
16	35B16	10	25	28	37	.24	40B16	12	34	28	48	.46	41B16	12	34	28	50	.44
17	35B17	10	26	28	38	.29	40B17	12	35	28	48	.51	41B17	12	35	28	52	.50
18	35B18	10	26	28	38	.33	40B18	12	37	28	58	.59	41B18	12	37	28	56	.57
19	35B19	10	31	28	46	.37	40B19	12	40	28	60	.67	41B19	12	40	28	60	.65
20	35B20	10	31	28	46	.39	40B20	12	43	28	60	.76	41B20	12	43	28	64	.74
21	35B21	12	31	28	46	.42	40B21	14	45	28	65	.84	41B21	14	45	28	68	.82
22	35B22	12	35	28	52	.46	40B22	14	46	28	65	.91	41B22	14	46	28	70	.87
23	35B23	12	35	28	52	.50	40B23	14	46	28	65	.94	41B23	14	46	28	70	.90
24	35B24	12	35	28	52	.54	40B24	14	46	28	70	.97	41B24	14	46	28	70	.92
25	35B25	12	38	28	58	.61	40B25	14	46	28	70	1.00	41B25	14	46	28	70	.95
26	35B26	12	38	28	58	.67	40B26	16	46	30	70	1.09	41B26	16	46	30	70	1.02
27	35B27	12	38	28	58	.73	40B27	16	46	30	70	1.12	41B27	16	46	30	70	1.06
28	35B28	12	40	28	60	.81	40B28	16	46	30	70	1.16	41B28	16	46	30	70	1.09
30	35B30	12	40	30	60	.92	40B30	16	54	30	80	1.45	41B30	16	54	30	80	1.39
31													41B31	16	60	30	90	1.67
32							40B32	16	60	30	90	1.78	41B32	16	60	30	90	1.71
33													41B33	16	60	30	90	1.75
34													41B34	16	60	30	90	1.79
35							40B35	16	60	30	90	1.92	41B35	16	60	30	90	1.82
36							40B36	16	60	35	90	2.18	41B36	16	60	35	90	2.07
37													41B37	16	60	35	90	2.11
38							40B38	16	60	35	90	2.28	41B38	16	60	35	90	2.16
39													41B39	16	60	35	90	2.20
40							40B40	16	60	35	90	2.38	41B40	16	60	35	90	2.24

All dimensions in mm. Material:- Steel with min. U.T.S. 600 N/mm².

Stock Sprockets can be reworked to customers bore and keyway requirements, on 48 hour service. All sprockets can be supplied with teeth induction hardened to 45Rc.

For Pitch Circle and Outside Diameters refer to equivalent size B.S. Sprockets. Refer pages 41 to 43.

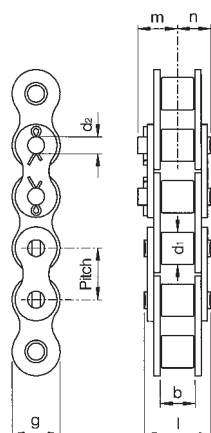

Standard Series Chain Dimensions

complying to ANSI B29.1

ANSI No.	ISO Chain Ref.	Pitch P Inches	Inside Width b min. mm	Roller Ø d1 max. mm	Ø d2 max. mm	Plate Depth g mm	Rivet Pin Length l max. mm	Length to Cotter Pin m mm	Length to Rivet Pin n mm	Bearing Area cm ²	Tensile Strength N	Weight Approx kg/m
35	*06C-1	3/8	4.77	5.08*	3.58	9.0	12.0	8.7	6.0	0.27	8,400	0.31
41	085	1/2	6.35	7.77	3.58	9.9	13.2	9.4	6.6	0.32	8,000	0.42
40	08A-1	1/2	7.85	7.95	3.96	11.8	16.6	10.7	8.3	0.44	14,800	0.62

*ANSI 35 Chain is bush chain to ISO 1395 - d1 dim is bush Ø.

Tel +44(0) 121 360 0155

Fax +44(0) 121 325 1079

Email sales@crossmorse.com

Standard Sprockets for 5/8", 3/4" & 1" Pitch American Standard Roller Chains Refs ANSI 50, 60 & 80



Email sales@crossmorse.com Fax +44(0) 121 325 1079 Tel +44(0) 121 360 0155

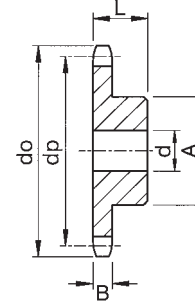
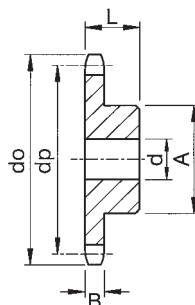
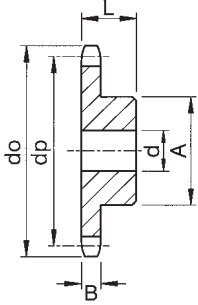

ANSI 50 Chain (ISO Ref 10A-1)
Pitch 15.875mm
Roller Dia. 10.16mm
Inside Width 9.40mm
Tooth Width B 9.0mm

ANSI 60 Chain (ISO Ref 12A-1)
Pitch 19.05mm
Roller Dia. 11.91mm
Inside Width 12.60mm
Tooth Width B 12.0mm

ANSI 80 Chain (ISO Ref 16A-1)
Pitch 25.4mm
Roller Dia. 15.88mm
Inside Width 15.80mm
Tooth Width B 15.0mm

No. Teeth Z	Sprockets for ANSI 50 Chain						Sprockets for ANSI 60 Chain						Sprockets for ANSI 80 Chain					
	Cat No.	min. bore d	max. bore d	L.T.B. L	Hub dia. A	App. Wt. kg	Cat No.	min. bore d	max. bore d	L.T.B. L	Hub dia. A	App. Wt. kg	Cat No.	min. bore d	max. bore d	L.T.B. L	Hub dia. A	App. Wt. kg
Steel Pinions																		
8	50B08	10	16	25	25	.12							80B08	16	28	35	42	.47
9	50B09	10	20	25	30	.17							80B09	16	34	35	50	.65
10	50B10	10	24	25	35	.22	60B10	12	28	30	42	.38	80B10	16	36	35	55	.82
11	50B11	12	25	30	37	.29	60B11	12	30	30	45	.51	80B11	16	40	40	61	1.06
12	50B12	12	28	30	42	.38	60B12	12	30	30	45	.65	80B12	16	46	40	69	1.34
13	50B13	12	31	30	47	.47	60B13	14	40	35	60	.80	80B13	16	52	40	78	1.68
14	50B14	12	35	30	52	.56	60B14	14	40	35	60	.97	80B14	16	56	40	84	2.03
15	50B15	12	38	30	57	.67	60B15	14	40	35	60	1.16	80B15	16	61	40	92	2.41
16	50B16	14	40	30	60	.76	60B16	16	50	35	75	1.34	80B16	20	67	45	100	3.12
17	50B17	14	40	30	60	.80	60B17	16	50	35	75	1.53	80B17	20	67	45	100	3.31
18	50B18	14	46	30	70	1.02	60B18	16	50	35	75	1.61	80B18	20	67	45	100	3.52
19	50B19	14	46	30	70	1.07	60B19	16	54	35	80	1.70	80B19	20	67	45	100	3.74
20	50B20	14	50	30	75	1.21	60B20	16	54	35	80	1.79	80B20	20	67	45	100	3.97
21	50B21	16	50	30	75	1.25	60B21	16	54	35	80	2.34	80B21	20	74	50	110	4.89
22	50B22	16	54	30	80	1.40	60B22	20	60	40	90	2.44	80B22	20	74	50	110	5.14
23	50B23	16	54	30	80	1.46	60B23	20	60	40	90	2.55	80B23	20	74	50	110	5.41
24	50B24	16	54	30	80	1.53	60B24	20	60	40	90	2.66	80B24	20	74	50	110	5.69
25	50B25	16	54	30	80	1.59	60B25	20	60	40	90	2.77	80B25	20	74	50	110	5.99
26	50B26	20	57	35	85	1.82	60B26	20	60	40	90	3.06	80B26	20	80	50	120	6.78
27	50B27	20	57	35	85	1.89	60B27	20	60	40	90	3.19	80B27	20	80	50	120	7.10
28	50B28	20	60	35	90	2.24	60B28	20	63	40	95	3.32	80B28	20	80	50	120	7.43
29	50B29	20	60	35	90	2.31							80B29	20	80	50	120	7.78
30	50B30	20	60	35	90	2.39	60B30	20	63	40	95	3.59	80B30	20	80	50	120	8.13
31	50B31	20	63	35	95	2.62												
32	50B32	20	63	35	95	2.71												
33	50B33	20	63	35	95	2.79												
34	50B34	20	63	35	95	2.88												
35	50B35	20	63	35	95	2.98												
36	50B36	20	67	35	100	3.23												
37	50B37	20	67	35	100	3.33												
38	50B38	20	67	35	100	3.43												
39	50B39	20	67	35	100	3.53												
40	50B40	20	67	35	100	3.64												

All dimensions in mm.

ANSI 50 Steel Pinions 8 to 35 tooth minimum U.T.S. 600N/mm² - Above 35T - 410N/mm²

ANSI 60 Steel Pinions 8 to 30 tooth minimum U.T.S. 600N/mm² - Above 30T - 410N/mm²

ANSI 80 Steel Pinions 8 to 21 tooth minimum U.T.S. 600N/mm² - Above 21T - 410N/mm²

Stock Sprockets can be reworked to customers bore and keyway requirements, on 48 hour service. Sprockets with minimum U.T.S. 600N/mm² can be induction hardened to 45Rc.

For Pitch Circle and Outside Diameters refer to equivalent size B.S. Sprockets. Refer pages 44 to 46.

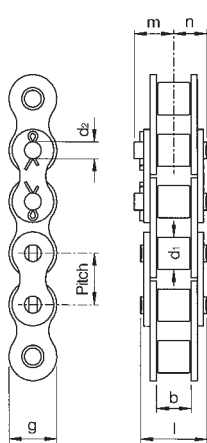

Standard Series Chain Dimensions

complying to ANSI B29.1

ANSI No.	ISO Chain Ref.	Pitch P Inches	Inside Width b min. mm	Roller Ø d: max. mm	Pin Ø d: max. mm	Plate Depth 9 mm	Rivet Pin Length l max. mm	Length to Cotter Pin m mm	Length to Rivet Pin n mm	Bearing Area cm ²	Tensile Strength N	Weight Approx kg/m
50	10A-1	5/8	9.40	10.16	5.08	15.0	20.2	14.3	10.1	0.70	24,400	1.04
60	12A-1	3/4	12.60	11.91	5.94	18.0	25.0	16.3	12.5	1.06	34,400	1.48
80	16A-1	1	15.80	15.88	7.92	24.0	32.6	18.8	16.3	1.79	64,500	2.50

Standard Platewheels for 8mm Pitch British Standard Chains Type 05B



Platewheels for Simplex Chain 05B-1 Conforming to ISO 606

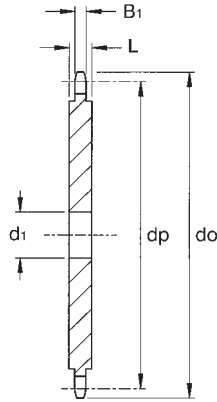

- Chain No: 05B-1
 Pitch 8.0mm
 Roller Dia. 5.0mm
 Inside Width 3.0mm
 Overall Width 11.7mm
 Tooth Width B₁ 2.8mm
 Plate Width L 2.8mm (up to 40T)
 4.0mm (41T & over)

Platewheels for Duplex Chain 05B-2 Conforming to ISO 606

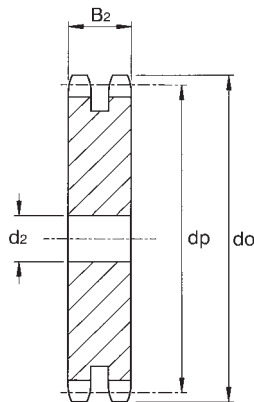

- Chain No: 05B-2
 Pitch 8.0mm
 Roller Dia. 5.0mm
 Inside Width 3.0mm
 Overall Width 17.4mm
 Tooth Width B₂ 8.3mm

No. Teeth	Pitch Circle Ø dp	Outside Ø do	Platewheel for 05B-1			Platewheel for 05B-1		
			Cat. No.	Min Bore d ₁	Approx. Weight kg	Cat. No.	Min Bore d ₂	Approx. Weight kg
8	20.90	24.0	P05B1-08	6	0.005	P05B2-08	8	0.010
9	23.39	26.6	P05B1-09	6	0.006	P05B2-09	8	0.014
10	25.89	29.2	P05B1-10	8	0.008	P05B2-10	8	0.019
11	28.39	31.7	P05B1-11	8	0.010	P05B2-11	8	0.025
12	30.91	34.2	P05B1-12	8	0.012	P05B2-12	8	0.031
13	33.42	36.7	P05B1-13	8	0.014	P05B2-13	8	0.038
14	35.95	39.2	P05B1-14	8	0.017	P05B2-14	8	0.046
15	38.48	41.7	P05B1-15	8	0.020	P05B2-15	8	0.054
16	41.01	44.3	P05B1-16	8	0.023	P05B2-16	10	0.061
17	43.53	46.8	P05B1-17	8	0.027	P05B2-17	10	0.071
18	46.07	49.3	P05B1-18	8	0.030	P05B2-18	10	0.081
19	48.61	51.9	P05B1-19	8	0.034	P05B2-19	10	0.092
20	51.14	54.4	P05B1-20	8	0.038	P05B2-20	10	0.104
21	53.68	57.0	P05B1-21	8	0.042	P05B2-21	10	0.116
22	56.21	59.5	P05B1-22	8	0.046	P05B2-22	10	0.129
23	58.75	62.0	P05B1-23	8	0.051	P05B2-23	10	0.143
24	61.29	64.6	P05B1-24	8	0.056	P05B2-24	10	0.157
25	63.83	67.5	P05B1-25	8	0.061	P05B2-25	10	0.172
26	66.37	69.5	P05B1-26	10	0.066	P05B2-26	12	0.185
27	68.91	72.2	P05B1-27	10	0.071	P05B2-27	12	0.202
28	71.45	74.8	P05B1-28	10	0.077	P05B2-28	12	0.219
29	73.99	77.3	P05B1-29	10	0.083	P05B2-29	12	0.236
30	76.53	79.8	P05B1-30	10	0.090	P05B2-30	12	0.255
31	79.08	82.4	P05B1-31	10	0.096	P05B2-31	12	0.274
32	81.61	84.9	P05B1-32	10	0.102	P05B2-32	12	0.293
33	84.16	87.5	P05B1-33	10	0.109	P05B2-33	12	0.314
34	86.70	90.0	P05B1-34	10	0.116	P05B2-34	12	0.335
35	89.25	92.5	P05B1-35	10	0.123	P05B2-35	12	0.356
36	91.79	95.0	P05B1-36	10	0.130	P05B2-35	12	0.378
37	94.33	97.6	P05B1-37	10	0.138	P05B2-37	12	0.401
38	96.88	100.2	P05B1-38	10	0.146	P05B2-38	12	0.425
39	99.42	102.7	P05B1-39	10	0.154	P05B2-39	12	0.449
40	101.97	105.3	P05B1-40	10	0.162	P05B2-40	12	0.474
41	104.51	107.8	P05B1-41	12	0.263	P05B2-41	14	0.494
42	107.05	110.4	P05B1-42	12	0.277	P05B2-42	14	0.520
43	109.60	112.9	P05B1-43	12	0.292	P05B2-43	14	0.547
44	112.14	115.5	P05B1-44	12	0.306	P05B2-44	14	0.575
45	114.69	118.0	P05B1-45	12	0.321	P05B2-45	14	0.603
46	117.23	120.6	P05B1-46	12	0.336	P05B2-46	14	0.632
47	119.77	123.1	P05B1-47	12	0.356	P05B2-47	14	0.662
48	122.32	125.6	P05B1-48	12	0.368	P05B2-48	14	0.692
49	124.86	128.2	P05B1-49	12	0.385	P05B2-49	14	0.723
50	127.41	130.7	P05B1-50	12	0.401	P05B2-50	14	0.754
51	129.95	133.3	P05B1-51	14	0.415	P05B2-51	16	0.787
52	132.49	135.8	P05B1-52	14	0.433	P05B2-52	16	0.819
53	135.04	138.4	P05B1-53	14	0.450	P05B2-53	16	0.853
54	137.59	140.9	P05B1-54	14	0.468	P05B2-54	16	0.887
55	140.13	143.5	P05B1-55	14	0.487	P05B2-55	16	0.922
56	142.68	146.0	P05B1-56	14	0.506	P05B2-56	16	0.958
57	145.22	148.6	P05B1-57	14	0.525	P05B2-57	16	0.994
58	147.77	151.0	P05B1-58	14	0.544	P05B2-58	16	1.031
59	150.31	153.6	P05B1-59	14	0.564	P05B2-59	16	1.068
60	152.85	156.2	P05B1-60	14	0.585	P05B2-60	16	1.106
62	157.95	162.0	P05B1-62	16	0.626	P05B2-62	20	1.178
64	163.04	167.1	P05B1-64	16	0.669	P05B2-64	20	1.259
65	165.58	169.6	P05B1-65	16	0.691	P05B2-65	20	1.300
66	168.13	172.2	P05B1-66	16	0.713	P05B2-66	20	1.342
68	173.22	177.3	P05B1-68	16	0.759	P05B2-68	20	1.429
70	178.31	182.4	P05B1-70	16	0.806	P05B2-70	20	1.518
72	183.41	187.5	P05B1-72	20	0.851	P05B2-72	20	1.609
75	191.04	195.1	P05B1-75	20	0.926	P05B2-75	20	1.752
76	193.59	197.7	P05B1-76	20	0.952	P05B2-76	20	1.800
78	198.68	202.8	P05B1-78	20	1.000	P05B2-78	20	1.900
80	203.77	207.9	P05B1-80	20	1.051	P05B2-80	20	2.005
85	216.50	220.6	P05B1-85	20	1.200	P05B2-85	20	2.270
90	229.23	233.4	P05B1-90	20	1.351	P05B2-90	20	2.555
95	241.96	246.1	P05B1-95	20	1.510	P05B2-95	20	2.855
100	254.68	258.9	P05B1-100	20	1.678	P05B2-100	20	3.170
110	280.15	284.3	P05B1-110	20	2.040	P05B2-110	20	3.855
114	290.33	294.5	P05B1-114	20	2.195	P05B2-114	20	4.150
120	305.61	310.0	P05B1-120	20	2.440	P05B2-120	20	4.610
125	318.34	322.5	P05B1-125	20	2.650	P05B2-125	20	5.010

All dimensions in mm.
 Stock Platewheels can be reworked to customers bore and keyway requirements, on 48 hour service.
 Platewheels manufactured in steel 8 to 40 tooth with a minimum U.T.S. 600N/mm² - Above 40T - 410N/mm²
 Platewheels 8 to 40 tooth can be supplied with teeth induction hardened to 45Rc."

Tel +44(0) 121 360 0155 Fax +44(0) 121 325 1079 Email sales@crossmorse.com

Standard Platewheels for 3/8" Pitch British Standard Chain Type 06B



Platewheels for Simplex Chain 06B-1 Conforming to ISO 606

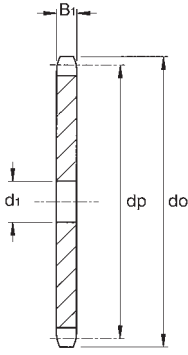

Chain No: 06B-1
Pitch 9.525mm
Roller Dia. 6.35mm
Inside Width 5.72mm
Overall Width 15.0mm
Tooth Width B₁ 5.3mm

Platewheels for Duplex Chain 06B-2 Conforming to ISO 606

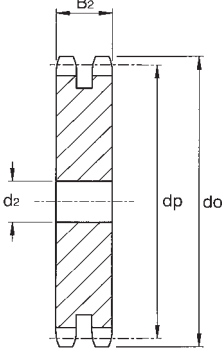

Chain No: 06B-2
Pitch 9.525mm
Roller Dia. 6.35mm
Inside Width 5.72mm
Overall Width 25.1mm
Tooth Width B₂ 15.4mm

Platewheels for Triplex Chain 06B-3 Conforming to ISO 606

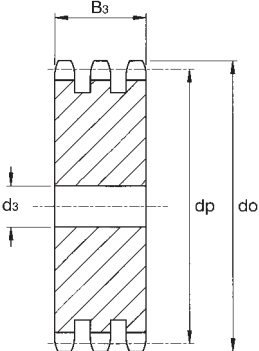

Chain No: 06B-3
Pitch 9.525mm
Roller Dia. 6.35mm
Inside Width 5.72mm
Overall Width 35.0mm
Tooth Width B₃ 25.6mm

No. Teeth	Pitch Circle Ø dp	Outside Ø do	Platewheel for 06B-1 Chain			Platewheel for 06B-2 Chain			Platewheel for 06B-3 Chain		
			Cat. No.	Min. Bore d ₁	Approx. Weight kg	Cat. No.	Min. Bore d ₂	Approx. Weight kg	Cat. No.	Min. Bore d ₃	Approx. Weight kg
8	24.89	28.0	P06B1-08	6	.01	P06B2-08	8	.03	P06B3-08	8	.04
9	27.85	31.0	P06B1-09	8	.02	P06B2-09	8	.04	P06B3-09	8	.06
10	30.82	34.0	P06B1-10	8	.02	P06B2-10	8	.05	P06B3-10	10	.08
11	33.80	37.0	P06B1-11	8	.03	P06B2-11	10	.06	P06B3-11	12	.10
12	36.80	40.0	P06B1-12	8	.03	P06B2-12	10	.08	P06B3-12	12	.12
13	39.79	43.0	P06B1-13	8	.04	P06B2-13	10	.10	P06B3-13	12	.15
14	42.80	46.3	P06B1-14	8	.05	P06B2-14	10	.12	P06B3-14	12	.19
15	45.81	49.3	P06B1-15	8	.06	P06B2-15	10	.14	P06B3-15	12	.22
16	48.82	52.3	P06B1-16	10	.06	P06B2-16	12	.16	P06B3-16	12	.26
17	51.83	55.3	P06B1-17	10	.07	P06B2-17	12	.19	P06B3-17	12	.30
18	54.85	58.3	P06B1-18	10	.08	P06B2-18	12	.21	P06B3-18	12	.35
19	57.87	61.3	P06B1-19	10	.09	P06B2-19	12	.24	P06B3-19	12	.40
20	60.89	64.3	P06B1-20	10	.10	P06B2-20	12	.27	P06B3-20	12	.45
21	63.91	68.0	P06B1-21	12	.11	P06B2-21	12	.31	P06B3-21	16	.48
22	66.93	71.0	P06B1-22	12	.13	P06B2-22	12	.34	P06B3-22	16	.54
23	69.95	73.5	P06B1-23	12	.14	P06B2-23	12	.38	P06B3-23	16	.60
24	72.97	77.0	P06B1-24	12	.15	P06B2-24	12	.42	P06B3-24	16	.66
25	76.02	80.0	P06B1-25	12	.17	P06B2-25	12	.46	P06B3-25	16	.73
26	79.02	83.0	P06B1-26	12	.18	P06B2-26	16	.49	P06B3-26	16	.80
27	82.02	86.0	P06B1-27	12	.20	P06B2-27	16	.53	P06B3-27	16	.87
28	85.07	89.0	P06B1-28	12	.21	P06B2-28	16	.57	P06B3-28	16	.94
29	88.09	92.0	P06B1-29	12	.23	P06B2-29	16	.62	P06B3-29	16	1.02
30	91.12	94.7	P06B1-30	12	.24	P06B2-30	16	.67	P06B3-30	16	1.10
31	94.15	98.3	P06B1-31	16	.26	P06B2-31	16	.72	P06B3-31	16	1.18
32	97.17	101.3	P06B1-32	16	.28	P06B2-32	16	.77	P06B3-32	16	1.27
33	100.20	104.3	P06B1-33	16	.30	P06B2-33	16	.82	P06B3-33	16	1.35
34	103.23	107.3	P06B1-34	16	.31	P06B2-34	16	.88	P06B3-34	16	1.45
35	106.26	110.4	P06B1-35	16	.33	P06B2-35	16	.94	P06B3-35	16	1.54
36	109.20	113.4	P06B1-36	16	.35	P06B2-36	16	1.00	P06B3-36	20	1.62
37	112.32	116.4	P06B1-37	16	.38	P06B2-37	16	1.06	P06B3-37	20	1.72
38	115.35	119.5	P06B1-38	16	.40	P06B2-38	16	1.12	P06B3-38	20	1.82
39	118.37	122.5	P06B1-39	16	.42	P06B2-39	16	1.18	P06B3-39	20	1.93
40	121.40	125.5	P06B1-40	16	.44	P06B2-40	16	1.25	P06B3-40	20	2.03
41	124.43	128.5	P06B1-41	16	.46	P06B2-41	20	1.30	P06B3-41	20	2.15
42	127.46	131.6	P06B1-42	16	.49	P06B2-42	20	1.37	P06B3-42	20	2.26
43	130.49	134.6	P06B1-43	16	.51	P06B2-43	20	1.44	P06B3-43	20	2.38
44	133.52	137.6	P06B1-44	16	.54	P06B2-44	20	1.52	P06B3-44	20	2.50
45	136.55	140.7	P06B1-45	16	.57	P06B2-45	20	1.59	P06B3-45	20	2.62
46	139.58	143.7	P06B1-46	20	.59	P06B2-46	20	1.67	P06B3-46	20	2.75
47	142.61	146.7	P06B1-47	20	.61	P06B2-47	20	1.75	P06B3-47	20	2.88
48	145.64	149.7	P06B1-48	20	.64	P06B2-48	20	1.83	P06B3-48	20	3.01
49	148.66	152.7	P06B1-49	20	.67	P06B2-49	20	1.91	P06B3-49	20	3.15
50	151.69	155.7	P06B1-50	20	.70	P06B2-50	20	1.99	P06B3-50	20	3.29
51	154.72	158.7	P06B1-51	20	.73	P06B2-51	20	2.08	P06B3-51	20	3.43
52	157.75	161.8	P06B1-52	20	.76	P06B2-52	20	2.17	P06B3-52	20	3.57
53	160.78	164.8	P06B1-53	20	.79	P06B2-53	20	2.25	P06B3-53	20	3.72
54	163.82	167.8	P06B1-54	20	.82	P06B2-54	20	2.35	P06B3-54	20	3.87
55	166.85	170.8	P06B1-55	20	.85	P06B2-55	20	2.44	P06B3-55	20	4.02
56	169.88	173.8	P06B1-56	20	.89	P06B2-56	20	2.53	P06B3-56	25	4.14
57	172.91	176.9	P06B1-57	20	.92	P06B2-57	20	2.63	P06B3-57	25	4.30
58	175.93	179.9	P06B1-58	20	.95	P06B2-58	20	2.73	P06B3-58	25	4.46
59	178.96	183.0	P06B1-59	20	.99	P06B2-59	20	2.83	P06B3-59	25	4.63
60	181.99	186.0	P06B1-60	20	1.02	P06B2-60	20	2.93	P06B3-60	25	4.80
62	188.06	192.1	P06B1-62	20	1.09	P06B2-62	25	3.11	P06B3-62	25	5.14
64	194.12	198.2	P06B1-64	20	1.17	P06B2-64	25	3.37	P06B3-64	25	5.49
65	197.15	201.6	P06B1-65	20	1.20	P06B2-65	25	3.44	P06B3-65	25	5.68
66	200.18	204.6	P06B1-66	20	1.23	P06B2-66	25	3.55	P06B3-66	25	5.86
68	206.24	210.7	P06B1-68	20	1.31	P06B2-68	25	3.78	P06B3-68	25	6.24
70	212.30	216.7	P06B1-70	20	1.39	P06B2-70	25	4.01	P06B3-70	25	6.63
72	218.37	222.8	P06B1-72	20	1.48	P06B2-72	25	4.26	P06B3-72	25	7.03
75	227.46	231.9	P06B1-75	20	1.61	P06B2-75	25	4.63	P06B3-75	25	7.66
76	230.49	234.9	P06B1-76	20	1.65	P06B2-76	25	4.76	P06B3-76	25	7.87
78	236.55	241.0	P06B1-78	20	1.74	P06B2-78	25	5.03	P06B3-78	25	8.31
80	242.77	247.1	P06B1-80	20	1.83	P06B2-80	25	5.30	P06B3-80	25	8.76
85	257.77	262.2	P06B1-85	25	2.08	P06B2-85	25	6.00	P06B3-85	25	9.93
90	272.93	277.4	P06B1-90	25	2.33	P06B2-90	25	6.76	P06B3-90	25	11.18
95	288.08	292.5	P06B1-95	25	2.61	P06B2-95	25	7.55	P06B3-95	25	12.50
100	303.25	307.7	P06B1-100	25	2.89	P06B2-100	25	8.39	P06B3-100	25	13.89
110	333.55	338.0	P06B1-110	25	3.51	P06B2-110	25	10.20	P06B3-110	25	16.89
114	345.68	349.5	P06B1-114	25	3.78	P06B2-114	25	10.98	P06B3-114	25	18.18
120	363.86	368.3	P06B1-120	25	4.18	P06B2-120	25	12.19	P06B3-120	25	20.19
125	379.02	383.5	P06B1-125	25	4.55	P06B2-125	25	13.25	P06B3-125	25	21.94

All dimensions in mm.

Stock Platewheels can be reworked to customers bore and keyway requirements, on 48 hour service.

Platewheels manufactured in steel 8 to 40 tooth with a minimum U.T.S. 600N/mm² - Above 40T - 410N/mm²

Platewheels 8 to 40 tooth can be supplied with teeth induction hardened to 45RC.

Tel +44(0) 121 360 0155 Fax +44(0) 121 325 1079 Email sales@crossmorse.com

Standard Platewheels for 1/2" Pitch Narrow Series Roller Chains



Platewheels for Simplex Chain 081 Conforming to ISO 606

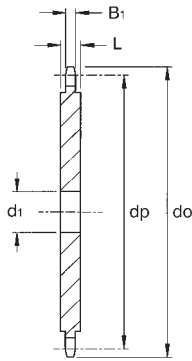

Chain No: 081
Pitch 12.7mm
Roller Dia. 7.75mm
Inside Width 3.3mm
Tooth Width B₁ 3.3mm
Plate Width:
L: 3.0mm (up to 40T)
L: 4.0mm (up to 85T)
L: 6.0mm (90T over)

Platewheels for Simplex Chain 083* Conforming to ISO 606

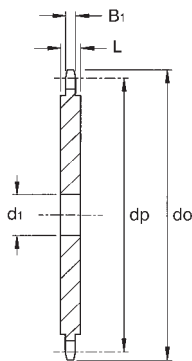

Chain No: 083
Pitch 12.7mm
Roller Dia. 7.75mm
Inside Width 4.88mm
Tooth Width B₁ 4.5mm
Plate Width:
L: 4.5mm (up to 85T)
L: 6.0mm (90T over)

No. Teeth	Pitch Circle Ø dp	Outside Ø do	Platewheel for 081 Chain			Platewheel for 083 Chain*		
			Cat. No.	Min. Bore d _i	Approx. Weight kg	Cat. No.	Min. Bore d _i	Approx. Weight kg
8	33.18	37.2	P081-08	8	.015	P083-08	8	.02
9	37.13	41.5	P081-09	8	.02	P083-09	8	.03
10	41.10	46.2	P081-10	8	.025	P083-10	8	.035
11	45.07	49.6	P081-11	8	.03	P083-11	8	.045
12	49.07	53.9	P081-12	8	.035	P083-12	8	.055
13	53.06	58.4	P081-13	8	.045	P083-13	8	.065
14	57.07	62.8	P081-14	8	.05	P083-14	8	.075
15	61.09	66.8	P081-15	8	.06	P083-15	8	.09
16	65.10	70.9	P081-16	10	.065	P083-16	10	.10
17	69.11	74.9	P081-17	10	.075	P083-17	10	.11
18	73.14	78.9	P081-18	10	.085	P083-18	10	.13
19	77.16	82.9	P081-19	10	.095	P083-19	10	.14
20	81.19	86.9	P081-20	10	.11	P083-20	10	.16
21	85.22	91.0	P081-21	10	.12	P083-21	10	.18
22	89.24	95.0	P081-22	10	.13	P083-22	10	.20
23	93.27	99.0	P081-23	10	.145	P083-23	10	.22
24	97.29	103.0	P081-24	10	.16	P083-24	10	.24
25	101.33	107.1	P081-25	10	.17	P083-25	10	.26
26	105.36	111.2	P081-26	12	.185	P083-26	12	.28
27	109.40	115.4	P081-27	12	.20	P083-27	12	.30
28	113.42	119.4	P081-28	12	.215	P083-28	12	.32
29	117.46	123.4	P081-29	12	.23	P083-29	12	.35
30	121.50	127.5	P081-30	12	.25	P083-30	12	.37
31	125.54	131.5	P081-31	12	.27	P083-31	12	.40
32	129.56	135.5	P081-32	12	.29	P083-32	12	.43
33	133.60	139.6	P081-33	12	.30	P083-33	12	.45
34	137.64	143.6	P081-34	12	.32	P083-34	12	.48
35	141.68	147.6	P081-35	12	.35	P083-35	12	.51
36	145.72	151.7	P081-36	16	.36	P083-36	16	.54
37	149.76	155.7	P081-37	16	.38	P083-37	16	.57
38	153.80	159.8	P081-38	16	.41	P083-38	16	.60
39	157.83	163.8	P081-39	16	.43	P083-39	16	.64
40	161.87	167.8	P081-40	16	.45	P083-40	16	.67
41	165.91	171.4	P081-41	16	.63	P083-41	16	.71
42	169.95	175.4	P081-42	16	.66	P083-42	16	.74
43	173.99	179.5	P081-43	16	.69	P083-43	16	.78
44	178.03	183.5	P081-44	16	.72	P083-44	16	.82
45	182.07	187.5	P081-45	16	.76	P083-45	16	.86
46	186.10	191.6	P081-46	20	.79	P083-46	20	.89
47	190.14	195.6	P081-47	20	.83	P083-47	20	.93
48	194.18	199.7	P081-48	20	.86	P083-48	20	.97
49	198.22	203.7	P081-49	20	.90	P083-49	20	1.02
50	202.26	207.8	P081-50	20	.94	P083-50	20	1.06
51	206.30	211.8	P081-51	20	.98	P083-51	20	1.10
52	210.34	215.9	P081-52	20	1.02	P083-52	20	1.15
53	214.37	219.9	P081-53	20	1.06	P083-53	20	1.19
54	218.43	224.0	P081-54	20	1.10	P083-54	20	1.24
55	222.46	228.0	P081-55	20	1.14	P083-55	20	1.29
56	226.50	232.1	P081-56	20	1.18	P083-56	20	1.34
57	230.54	236.1	P081-57	20	1.23	P083-57	20	1.39
58	234.58	240.2	P081-58	20	1.27	P083-58	20	1.44
59	238.62	244.2	P081-59	20	1.32	P083-59	20	1.49
60	242.66	248.2	P081-60	20	1.36	P083-60	20	1.54
62	250.75	256.7	P081-62	20	1.46	P083-62	20	1.64
64	258.82	264.8	P081-64	20	1.55	P083-64	20	1.75
65	262.86	268.8	P081-65	20	1.60	P083-65	20	1.81
66	266.90	272.9	P081-66	25	1.65	P083-66	25	1.86
68	274.99	280.9	P081-68	25	1.75	P083-68	25	1.98
70	283.07	289.0	P081-70	25	1.86	P083-70	25	2.10
72	291.16	297.1	P081-72	25	1.97	P083-72	25	2.22
76	307.33	313.3	P081-76	25	2.20	P083-76	25	2.48
78	315.40	321.4	P081-78	25	2.32	P083-78	25	2.62
80	323.48	329.4	P081-80	25	2.44	P083-80	25	2.76
85	343.70	349.7	P081-85	25	2.76	P083-85	25	3.12
90	363.90	369.9	P081-90	25	4.70	P083-90	25	4.70
95	384.10	390.1	P081-95	25	5.25	P083-95	25	5.25
100	404.13	410.3	P081-100	25	5.85	P083-100	25	5.85
110	444.74	450.7	P081-110	25	7.10	P083-110	25	7.10
114	460.90	466.9	P081-114	25	7.60	P083-114	25	7.60
120	485.16	491.2	P081-120	25	8.45	P083-120	25	8.45
125	505.37	511.4	P081-125	25	9.18	P083-125	25	9.18

All dimensions in mm. Material - Steel with min. U.T.S. 490 N/mm²
Stock Platewheels can be bored to customers requirements, or supplied with threaded bore to suit adapters. Ref. page 69, all on 48 hour service.
Platewheels manufactured in steel 8 to 40 tooth with a minimum U.T.S. 600N/mm² - Above 40T - 410N/mm²
Platewheels 8 to 40 tooth can be supplied with teeth induction hardened to 45Rc.
*Also suitable for 084 and 08N Chains.

Tel +44(0) 121 360 0155 Fax +44(0) 121 325 1079 Email sales@crossmorse.com

Standard Platewheels for 1/2" Pitch British Standard Chain Type 08B



Platewheels for Simplex Chain 08B-1 Conforming to ISO 606

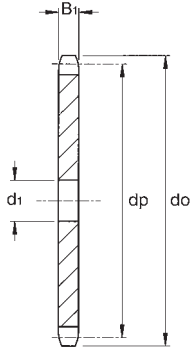

Chain No: 08B-1
Pitch 12.7mm
Roller Dia. 8.51mm
Inside Width 7.75mm
Overall Width 18.3mm
Tooth Width B₁ 7.2mm

Platewheels for Duplex Chain 08B-2 Conforming to ISO 606

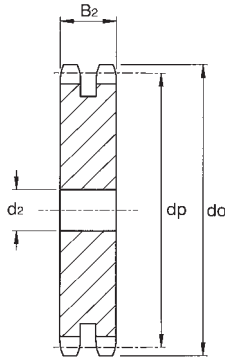

Chain No: 08B-2
Pitch 12.7mm
Roller Dia. 8.51mm
Inside Width 7.75mm
Overall Width 32.1mm
Tooth Width B₂ 21.0mm

Platewheels for Triplex Chain 08B-3 Conforming to ISO 606

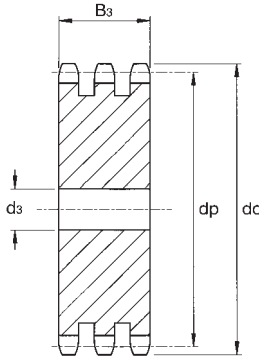

Chain No: 08B-3
Pitch 12.7mm
Roller Dia. 8.51mm
Inside Width 7.75mm
Overall Width 46.1mm
Tooth Width B₃ 34.9mm

No. Teeth	Pitch Circle Ø dp	Outside Ø do	Platewheel for 08B-1 Chain			Platewheel for 08B-2 Chain			Platewheel for 08B-3 Chain		
			Cat. No.	Min. Bore d _i	Approx. Weight kg	Cat. No.	Min. Bore d _i	Approx. Weight kg	Cat. No.	Min. Bore d _i	Approx. Weight kg
8	33.18	37.2	P08B1-08	8	.03	P08B2-08	10	.07	P08B3-08	10	.11
9	37.13	41.0	P08B1-09	8	.04	P08B2-09	10	.10	P08B3-09	10	.15
10	41.10	45.2	P08B1-10	8	.05	P08B2-10	10	.13	P08B3-10	10	.21
11	45.07	48.7	P08B1-11	10	.07	P08B2-11	10	.17	P08B3-11	12	.26
12	49.07	53.0	P08B1-12	10	.08	P08B2-12	10	.21	P08B3-12	12	.32
13	53.06	57.4	P08B1-13	10	.10	P08B2-13	10	.25	P08B3-13	12	.40
14	57.07	61.8	P08B1-14	10	.11	P08B2-14	10	.30	P08B3-14	12	.48
15	61.09	65.5	P08B1-15	10	.13	P08B2-15	10	.35	P08B3-15	12	.57
16	65.10	69.5	P08B1-16	10	.15	P08B2-16	12	.41	P08B3-16	16	.64
17	69.11	73.6	P08B1-17	10	.17	P08B2-17	12	.47	P08B3-17	16	.74
18	73.14	77.8	P08B1-18	10	.20	P08B2-18	12	.53	P08B3-18	16	.85
19	77.16	81.7	P08B1-19	10	.22	P08B2-19	12	.61	P08B3-19	16	.97
20	81.19	85.8	P08B1-20	10	.25	P08B2-20	12	.68	P08B3-20	16	1.09
21	85.22	89.7	P08B1-21	12	.27	P08B2-21	16	.74	P08B3-21	16	1.22
22	89.24	93.8	P08B1-22	12	.30	P08B2-22	16	.83	P08B3-22	16	1.36
23	93.27	98.2	P08B1-23	12	.33	P08B2-23	16	.91	P08B3-23	16	1.50
24	97.29	101.8	P08B1-24	12	.36	P08B2-24	16	1.01	P08B3-24	16	1.65
25	101.33	105.8	P08B1-25	12	.40	P08B2-25	16	1.10	P08B3-25	16	1.81
26	105.36	110.0	P08B1-26	16	.43	P08B2-26	16	1.20	P08B3-26	16	1.98
27	109.40	114.0	P08B1-27	16	.46	P08B2-27	16	1.31	P08B3-27	16	2.15
28	113.42	118.0	P08B1-28	16	.50	P08B2-28	16	1.42	P08B3-28	16	2.33
29	117.46	122.0	P08B1-29	16	.54	P08B2-29	16	1.53	P08B3-29	16	2.52
30	121.50	126.1	P08B1-30	16	.58	P08B2-30	16	1.64	P08B3-30	16	2.71
31	125.54	130.2	P08B1-31	16	.62	P08B2-31	16	1.77	P08B3-31	20	2.88
32	129.56	134.3	P08B1-32	16	.66	P08B2-32	16	1.89	P08B3-32	20	3.09
33	133.60	138.4	P08B1-33	16	.71	P08B2-33	16	2.02	P08B3-33	20	3.30
34	137.64	142.6	P08B1-34	16	.75	P08B2-34	16	2.16	P08B3-34	20	3.52
35	141.69	146.7	P08B1-35	16	.80	P08B2-35	16	2.29	P08B3-35	20	3.75
36	145.72	151.0	P08B1-36	16	.85	P08B2-36	20	2.42	P08B3-36	20	3.99
37	149.76	154.6	P08B1-37	16	.90	P08B2-37	20	2.56	P08B3-37	20	4.23
38	153.80	158.6	P08B1-38	16	.95	P08B2-38	20	2.71	P08B3-38	20	4.48
39	157.83	162.7	P08B1-39	16	1.00	P08B2-39	20	2.87	P08B3-39	20	4.74
40	161.87	166.8	P08B1-40	16	1.06	P08B2-40	20	3.03	P08B3-40	20	5.01
41	165.91	171.4	P08B1-41	20	1.11	P08B2-41	20	3.19	P08B3-41	25	5.23
42	169.95	175.4	P08B1-42	20	1.16	P08B2-42	20	3.36	P08B3-42	25	5.51
43	173.99	179.7	P08B1-43	20	1.22	P08B2-43	20	3.53	P08B3-43	25	5.79
44	178.03	183.8	P08B1-44	20	1.28	P08B2-44	20	3.71	P08B3-44	25	6.08
45	182.07	188.0	P08B1-45	20	1.34	P08B2-45	20	3.89	P08B3-45	25	6.38
46	186.10	192.1	P08B1-46	20	1.41	P08B2-46	20	4.07	P08B3-46	25	6.69
47	190.14	196.2	P08B1-47	20	1.47	P08B2-47	20	4.26	P08B3-47	25	7.00
48	194.18	200.3	P08B1-48	20	1.54	P08B2-48	20	4.45	P08B3-48	25	7.33
49	198.22	204.3	P08B1-49	20	1.60	P08B2-49	20	4.65	P08B3-49	25	7.65
50	202.26	208.3	P08B1-50	20	1.67	P08B2-50	20	4.85	P08B3-50	25	7.99
51	206.30	212.1	P08B1-51	20	1.74	P08B2-51	25	5.03	P08B3-51	25	8.33
52	210.34	216.1	P08B1-52	20	1.81	P08B2-52	25	5.24	P08B3-52	25	8.68
53	214.37	220.2	P08B1-53	20	1.89	P08B2-53	25	5.46	P08B3-53	25	9.04
54	218.43	224.1	P08B1-54	20	1.96	P08B2-54	25	5.67	P08B3-54	25	9.40
55	222.46	228.1	P08B1-55	20	2.03	P08B2-55	25	5.90	P08B3-55	25	9.77
56	226.50	232.2	P08B1-56	20	2.11	P08B2-56	25	6.12	P08B3-56	25	10.15
57	230.54	236.4	P08B1-57	20	2.19	P08B2-57	25	6.36	P08B3-57	25	10.53
58	234.58	240.5	P08B1-58	20	2.27	P08B2-58	25	6.59	P08B3-58	25	10.92
59	238.62	244.5	P08B1-59	20	2.35	P08B2-59	25	6.83	P08B3-59	25	11.32
60	242.66	248.6	P08B1-60	20	2.43	P08B2-60	25	7.07	P08B3-60	25	11.73
62	250.75	256.9	P08B1-62	25	2.59	P08B2-62	25	7.57	P08B3-62	25	12.56
64	258.82	265.1	P08B1-64	25	2.77	P08B2-64	25	8.09	P08B3-64	25	13.42
65	262.86	269.0	P08B1-65	25	2.86	P08B2-65	25	8.36	P08B3-65	25	13.86
66	266.90	273.0	P08B1-66	25	2.95	P08B2-66	25	8.63	P08B3-66	25	14.31
68	274.99	281.0	P08B1-68	25	3.13	P08B2-68	25	9.18	P08B3-68	25	15.22
70	283.07	289.0	P08B1-70	25	3.33	P08B2-70	25	9.75	P08B3-70	25	16.17
72	291.16	297.2	P08B1-72	25	3.52	P08B2-72	25	10.33	P08B3-72	25	17.14
75	303.27	309.2	P08B1-75	25	3.83	P08B2-75	25	11.24	P08B3-75	25	18.65
76	307.33	313.3	P08B1-76	25	3.93	P08B2-76	25	11.55	P08B3-76	25	19.17
78	315.40	321.4	P08B1-78	25	4.15	P08B2-78	25	12.19	P08B3-78	25	20.23
80	323.48	329.4	P08B1-80	25	4.37	P08B2-80	25	12.84	P08B3-80	25	21.31
85	343.70	349.0	P08B1-85	25	4.94	P08B2-85	25	14.55	P08B3-85	25	24.15
90	363.90	369.9	P08B1-90	25	5.55	P08B2-90	25	16.36	P08B3-90	25	27.17
95	384.11	390.1	P08B1-95	25	6.91	P08B2-95	25	18.28	P08B3-95	25	30.36
100	404.32	410.3	P08B1-100	25	7.67	P08B2-100	25	20.30	P08B3-100	25	33.73
110	444.74	450.7	P08B1-110	25	9.33	P08B2-110	25	24.67	P08B3-110	25	40.99
114	460.90	466.9	P08B1-114	25	10.04	P08B2-114	25	26.53	P08B3-114	25	44.09
120	485.16	491.2	P08B1-120	25	11.15	P08B2-120	25	29.45	P08B3-120	25	48.96
125	505.37	511.3	P08B1-125	25	12.12	P08B2-125	25	32.01	P08B3-125	25	53.21

All dimensions in mm.
Stock Platewheels can be reworked to customers bore and keyway requirements, on 48 hour service.
Platewheels manufactured in steel 8 to 40 tooth with a minimum U.T.S. 600N/mm² - Above 40T - 410N/mm²
Platewheels 8 to 40 tooth can be supplied with teeth induction hardened to 45Rc.

Tel +44(0) 121 360 0155 Fax +44(0) 121 325 1079 Email sales@crossmorse.com

Standard Platewheels for 5/8" Pitch British Standard Chain Type 10B



Platewheels for Simplex Chain 10B-1 Conforming to ISO 606

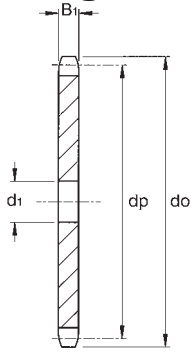

Chain No: 10B-1
Pitch 15.875mm
Roller Dia. 10.16mm
Inside Width 9.52mm
Overall Width 20.8mm
Tooth Width B₁ 9.1mm

Platewheels for Duplex Chain 10B-2 Conforming to ISO 606

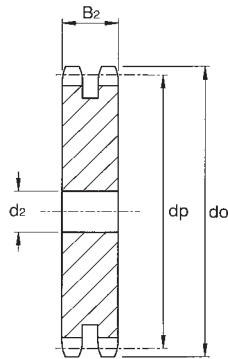

Chain No: 10B-2
Pitch 15.875mm
Roller Dia. 10.16mm
Inside Width 9.52mm
Overall Width 37.6mm
Tooth Width B₂ 25.5mm

Platewheels for Triplex Chain 10B-3 Conforming to ISO 606

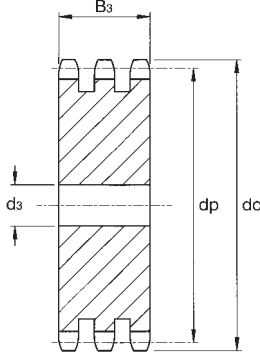

Chain No: 10B-3
Pitch 15.875mm
Roller Dia. 10.16mm
Inside Width 9.52mm
Overall Width 54.1mm
Tooth Width B₃ 42.1mm

No. Teeth	Pitch Circle Ø dp	Outside Ø do	Platewheel for 10B-1 Chain			Platewheel for 10B-2 Chain			Platewheel for 10B-3 Chain		
			Cat. No.	Min. Bore d _i	Approx. Weight kg	Cat. No.	Min. Bore d _i	Approx. Weight kg	Cat. No.	Min. Bore d _i	Approx. Weight kg
8	41.48	47.0	P10B1-08	10	.06	P10B2-08	10	.15	P10B3-08	12	.23
9	46.42	52.6	P10B1-09	10	.08	P10B2-09	10	.21	P10B3-09	12	.32
10	51.37	57.5	P10B1-10	10	.11	P10B2-10	10	.27	P10B3-10	12	.42
11	56.34	63.0	P10B1-11	10	.13	P10B2-11	12	.34	P10B3-11	12	.54
12	61.34	68.0	P10B1-12	10	.16	P10B2-12	12	.42	P10B3-12	12	.66
13	66.32	73.0	P10B1-13	10	.19	P10B2-13	12	.51	P10B3-13	12	.81
14	71.34	78.0	P10B1-14	12	.23	P10B2-14	12	.59	P10B3-14	12	.96
15	76.36	83.0	P10B1-15	12	.26	P10B2-15	12	.70	P10B3-15	12	1.13
16	81.37	88.0	P10B1-16	12	.30	P10B2-16	12	.81	P10B3-16	16	1.29
17	86.38	93.0	P10B1-17	12	.35	P10B2-17	12	.93	P10B3-17	16	1.48
18	91.42	98.3	P10B1-18	12	.39	P10B2-18	12	1.06	P10B3-18	16	1.69
19	96.45	103.3	P10B1-19	12	.44	P10B2-19	12	1.19	P10B3-19	16	1.91
20	101.49	108.4	P10B1-20	12	.49	P10B2-20	12	1.33	P10B3-20	16	2.15
21	106.52	113.4	P10B1-21	12	.55	P10B2-21	16	1.47	P10B3-21	16	2.39
22	111.55	118.0	P10B1-22	12	.60	P10B2-22	16	1.63	P10B3-22	16	2.66
23	116.58	123.5	P10B1-23	12	.66	P10B2-23	16	1.79	P10B3-23	16	2.93
24	121.62	128.3	P10B1-24	12	.72	P10B2-24	16	1.97	P10B3-24	16	3.22
25	126.66	134.0	P10B1-25	12	.79	P10B2-25	16	2.15	P10B3-25	16	3.52
26	131.70	139.0	P10B1-26	16	.85	P10B2-26	16	2.32	P10B3-26	20	3.80
27	136.75	144.0	P10B1-27	16	.92	P10B2-27	16	2.52	P10B3-27	20	4.12
28	141.78	148.7	P10B1-28	16	1.00	P10B2-28	16	2.73	P10B3-28	20	4.46
29	146.83	153.8	P10B1-29	16	1.07	P10B2-29	16	2.94	P10B3-29	20	4.82
30	151.87	158.8	P10B1-30	16	1.15	P10B2-30	16	3.16	P10B3-30	20	5.18
31	156.92	163.9	P10B1-31	16	1.23	P10B2-31	20	3.39	P10B3-31	20	5.57
32	161.95	168.9	P10B1-32	16	1.32	P10B2-32	20	3.64	P10B3-32	20	5.96
33	167.00	174.5	P10B1-33	16	1.40	P10B2-33	20	3.88	P10B3-33	20	6.37
34	172.05	179.0	P10B1-34	16	1.49	P10B2-34	20	4.14	P10B3-34	20	6.79
35	177.10	184.1	P10B1-35	16	1.59	P10B2-35	20	4.40	P10B3-35	20	7.22
36	182.15	189.1	P10B1-36	20	1.67	P10B2-36	20	4.67	P10B3-36	25	7.61
37	187.20	194.2	P10B1-37	20	1.77	P10B2-37	20	4.95	P10B3-37	25	8.07
38	192.24	199.2	P10B1-38	20	1.87	P10B2-38	20	5.24	P10B3-38	25	8.54
39	197.29	204.2	P10B1-39	20	1.98	P10B2-39	20	5.53	P10B3-39	25	9.03
40	202.34	209.3	P10B1-40	20	2.08	P10B2-40	20	5.83	P10B3-40	25	9.53
41	207.39	214.8	P10B1-41	20	2.19	P10B2-41	20	6.15	P10B3-41	25	10.04
42	212.44	219.9	P10B1-42	20	2.31	P10B2-42	20	6.46	P10B3-42	25	10.56
43	217.49	224.9	P10B1-43	20	2.42	P10B2-43	20	6.79	P10B3-43	25	11.10
44	222.53	230.0	P10B1-44	20	2.54	P10B2-44	20	7.13	P10B3-44	25	11.66
45	227.58	235.0	P10B1-45	20	2.66	P10B2-45	20	7.47	P10B3-45	25	12.22
46	232.63	240.1	P10B1-46	20	2.78	P10B2-46	25	7.78	P10B3-46	25	12.80
47	237.68	245.1	P10B1-47	20	2.91	P10B2-47	25	8.14	P10B3-47	25	13.39
48	242.73	250.2	P10B1-48	20	3.04	P10B2-48	25	8.51	P10B3-48	25	14.00
49	247.78	255.2	P10B1-49	20	3.17	P10B2-49	25	8.89	P10B3-49	25	14.62
50	252.82	260.3	P10B1-50	20	3.30	P10B2-50	25	9.27	P10B3-50	25	15.25
51	257.87	265.3	P10B1-51	20	3.44	P10B2-51	25	9.66	P10B3-51	25	15.89
52	262.92	270.4	P10B1-52	20	3.58	P10B2-52	25	10.06	P10B3-52	25	16.55
53	267.97	275.4	P10B1-53	20	3.72	P10B2-53	25	10.47	P10B3-53	25	17.22
54	273.03	280.5	P10B1-54	20	3.87	P10B2-54	25	10.88	P10B3-54	25	17.91
55	278.08	285.5	P10B1-55	20	4.02	P10B2-55	25	11.30	P10B3-55	25	18.60
56	283.13	290.6	P10B1-56	25	4.16	P10B2-56	25	11.74	P10B3-56	25	19.31
57	288.18	296.0	P10B1-57	25	4.31	P10B2-57	25	12.17	P10B3-57	25	20.04
58	293.23	300.7	P10B1-58	25	4.46	P10B2-58	25	12.62	P10B3-58	25	20.78
59	298.27	305.7	P10B1-59	25	4.63	P10B2-59	25	13.08	P10B3-59	25	21.53
60	303.32	310.8	P10B1-60	25	4.79	P10B2-60	25	13.54	P10B3-60	25	22.29
62	313.43	321.4	P10B1-62	25	5.12	P10B2-62	25	14.49	P10B3-62	30	23.79
64	323.53	331.5	P10B1-64	25	5.46	P10B2-64	25	15.47	P10B3-64	30	25.41
65	328.58	336.5	P10B1-65	25	5.64	P10B2-65	25	15.97	P10B3-65	30	26.24
66	333.63	341.6	P10B1-66	25	5.82	P10B2-66	25	16.48	P10B3-66	30	27.08
68	343.74	351.7	P10B1-68	25	6.18	P10B2-68	25	17.53	P10B3-68	30	28.81
70	353.84	361.8	P10B1-70	25	6.56	P10B2-70	25	18.61	P10B3-70	30	30.59
72	363.95	371.9	P10B1-72	25	6.95	P10B2-72	25	19.72	P10B3-72	30	32.42
75	379.09	387.1	P10B1-75	25	7.55	P10B2-75	25	21.44	P10B3-75	30	35.26
76	384.16	392.1	P10B1-76	25	7.76	P10B2-76	25	22.04	P10B3-76	30	36.24
78	394.25	402.2	P10B1-78	25	8.18	P10B2-78	25	23.24	P10B3-78	30	38.23
80	404.35	412.3	P10B1-80	25	8.61	P10B2-80	30	24.44	P10B3-80	30	40.27
85	429.62	437.6	P10B1-85	30	9.72	P10B2-85	30	27.67	P10B3-85	30	45.61
90	454.88	462.8	P10B1-90	30	10.92	P10B2-90	30	31.10	P10B3-90	30	51.29
95	480.14	488.5	P10B1-95	30	12.19	P10B2-95	30	34.74	P10B3-95	30	57.29
100	505.39	513.4	P10B1-100	30	13.53	P10B2-100	30	38.57	P10B3-100	30	62.62
110	555.92	563.9	P10B1-110	30	16.41	P10B2-110	30	46.84	P10B3-110	30	77.28
114	576.13	584.1	P10B1-114	30	17.64	P10B2-114	30	50.37	P10B3-114	30	83.11
120	606.45	614.4	P10B1-120	30	19.57	P10B2-120	30	55.91	P10B3-120	30	92.25
125	631.51	639.7	P10B1-125	30	21.25	P10B2-125	30	60.74	P10B3-125	30	100.24

All dimensions in mm.
Stock Platewheels can be reworked to customers bore and keyway requirements, on 48 hour service.
Platewheels manufactured in steel 8 to 35 tooth with a minimum U.T.S. 600N/mm² - Above 35T - 410N/mm²
Platewheels 8 to 35 tooth can be supplied with teeth induction hardened to 45Rc.

Tel +44(0) 121 360 0155

Fax +44(0) 121 325 1079

Email sales@crossmorse.com

Standard Platewheels for 3/4" Pitch British Standard Chain Type 12B



Platewheels for Simplex Chain 12B-1 Conforming to ISO 606

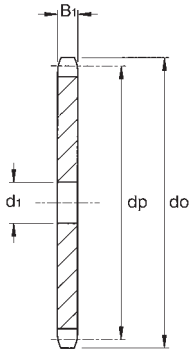

Chain No: 12B-1
Pitch 19.05mm
Roller Dia. 12.07mm
Inside Width 11.68mm
Overall Width 24.5mm
Tooth Width B₁ 11.1mm

Platewheels for Duplex Chain 12B-2 Conforming to ISO 606

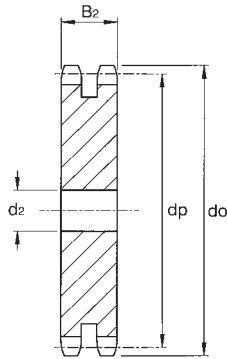

Chain No: 12B-2
Pitch 19.05mm
Roller Dia. 12.07mm
Inside Width 11.68mm
Overall Width 44.0mm
Tooth Width B₂ 30.3mm

Platewheels for Triplex Chain 12B-3 Conforming to ISO 606

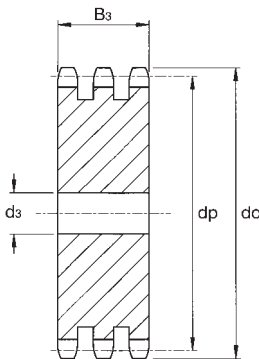

Chain No: 12B-3
Pitch 19.05mm
Roller Dia. 12.07mm
Inside Width 11.68mm
Overall Width 63.4mm
Tooth Width B₃ 49.8mm

No. Teeth	Pitch Circle Ø dp	Outside Ø do	Platewheel for 12B-1 Chain			Platewheel for 12B-2 Chain			Platewheel for 12B-3 Chain		
			Cat. No.	Min. Bore d _i	Approx. Weight kg	Cat. No.	Min. Bore d _i	Approx. Weight kg	Cat. No.	Min. Bore d _i	Approx. Weight kg
8	49.78	57.6	P12B1-08	12	.11	P12B2-08	12	.26	P12B3-08	12	.42
9	55.70	62.0	P12B1-09	12	.15	P12B2-09	12	.36	P12B3-09	12	.57
10	61.64	69.0	P12B1-10	12	.19	P12B2-10	12	.47	P12B3-10	12	.75
11	67.61	75.0	P12B1-11	14	.24	P12B2-11	14	.59	P12B3-11	16	.91
12	73.61	81.5	P12B1-12	14	.29	P12B2-12	14	.73	P12B3-12	16	1.13
13	79.59	87.5	P12B1-13	14	.34	P12B2-13	14	.88	P12B3-13	16	1.38
14	85.61	93.6	P12B1-14	14	.40	P12B2-14	14	1.02	P12B3-14	16	1.64
15	91.63	99.8	P12B1-15	14	.46	P12B2-15	14	1.20	P12B3-15	16	1.93
16	97.65	105.5	P12B1-16	14	.53	P12B2-16	16	1.39	P12B3-16	16	2.24
17	103.67	111.5	P12B1-17	14	.61	P12B2-17	16	1.59	P12B3-17	16	2.58
18	109.71	118.0	P12B1-18	14	.69	P12B2-18	16	1.81	P12B3-18	16	2.94
19	115.75	124.2	P12B1-19	14	.78	P12B2-19	16	2.05	P12B3-19	16	3.32
20	121.78	129.7	P12B1-20	14	.87	P12B2-20	16	2.29	P12B3-20	16	3.72
21	127.82	136.0	P12B1-21	16	.96	P12B2-21	16	2.53	P12B3-21	20	4.14
22	133.86	141.8	P12B1-22	16	1.06	P12B2-22	16	2.80	P12B3-22	20	4.59
23	139.90	149.0	P12B1-23	16	1.17	P12B2-23	16	3.09	P12B3-23	20	5.06
24	145.94	153.9	P12B1-24	16	1.28	P12B2-24	16	3.39	P12B3-24	20	5.55
25	152.00	160.0	P12B1-25	16	1.39	P12B2-25	16	3.70	P12B3-25	20	6.07
26	158.04	165.9	P12B1-26	16	1.51	P12B2-26	20	4.03	P12B3-26	20	6.61
27	164.09	172.3	P12B1-27	16	1.64	P12B2-27	20	4.38	P12B3-27	20	7.17
28	170.13	178.0	P12B1-28	16	1.77	P12B2-28	20	4.73	P12B3-28	20	7.75
29	176.19	184.1	P12B1-29	16	1.90	P12B2-29	20	5.10	P12B3-29	20	8.35
30	182.25	190.5	P12B1-30	16	2.04	P12B2-30	20	5.49	P12B3-30	20	8.98
31	188.31	196.3	P12B1-31	20	2.18	P12B2-31	20	5.88	P12B3-31	25	9.63
32	194.36	203.3	P12B1-32	20	2.33	P12B2-32	20	6.29	P12B3-32	25	10.31
33	200.40	209.2	P12B1-33	20	2.48	P12B2-33	20	6.72	P12B3-33	25	11.00
34	206.46	214.6	P12B1-34	20	2.64	P12B2-34	20	7.16	P12B3-34	25	11.72
35	212.52	221.0	P12B1-35	20	2.80	P12B2-35	20	7.61	P12B3-35	25	12.42
36	218.58	226.8	P12B1-36	20	2.97	P12B2-36	25	8.04	P12B3-36	25	13.22
37	224.64	232.9	P12B1-37	20	3.15	P12B2-37	25	8.52	P12B3-37	25	14.01
38	230.69	239.0	P12B1-38	20	3.33	P12B2-38	25	9.01	P12B3-38	25	14.82
39	236.75	245.1	P12B1-39	20	3.51	P12B2-39	25	9.52	P12B3-39	25	15.65
40	242.81	251.3	P12B1-40	20	3.70	P12B2-40	25	10.04	P12B3-40	25	16.51
41	248.87	257.3	P12B1-41	25	3.88	P12B2-41	25	10.57	P12B3-41	25	17.38
42	254.93	264.5	P12B1-42	25	4.08	P12B2-42	25	11.12	P12B3-42	25	18.28
43	260.98	270.5	P12B1-43	25	4.28	P12B2-43	25	11.68	P12B3-43	25	19.20
44	267.04	276.5	P12B1-44	25	4.49	P12B2-44	25	12.26	P12B3-44	25	20.15
45	273.10	282.5	P12B1-45	25	4.70	P12B2-45	25	12.85	P12B3-45	25	21.11
46	279.16	287.9	P12B1-46	25	4.92	P12B2-46	25	13.45	P12B3-46	25	22.10
47	285.21	294.0	P12B1-47	25	5.14	P12B2-47	25	14.07	P12B3-47	25	23.11
48	291.27	300.1	P12B1-48	25	5.37	P12B2-48	25	14.70	P12B3-48	25	24.15
49	297.33	306.2	P12B1-49	25	5.60	P12B2-49	25	15.35	P12B3-49	25	25.21
50	303.39	312.3	P12B1-50	25	5.84	P12B2-50	25	16.01	P12B3-50	25	26.29
51	309.45	318.4	P12B1-51	25	6.08	P12B2-51	25	16.68	P12B3-51	25	27.39
52	315.50	324.5	P12B1-52	25	6.33	P12B2-52	25	17.36	P12B3-52	25	28.51
53	321.56	330.5	P12B1-53	25	6.58	P12B2-53	25	18.06	P12B3-53	25	29.66
54	327.64	336.6	P12B1-54	25	6.84	P12B2-54	25	18.78	P12B3-54	25	30.83
55	333.70	342.7	P12B1-55	25	7.10	P12B2-55	25	19.50	P12B3-55	25	32.02
56	339.75	348.7	P12B1-56	25	7.37	P12B2-56	25	20.25	P12B3-56	30	33.04
57	345.81	355.4	P12B1-57	25	7.64	P12B2-57	25	21.00	P12B3-57	30	34.28
58	351.87	361.5	P12B1-58	25	7.91	P12B2-58	25	21.77	P12B3-58	30	35.54
59	357.93	367.5	P12B1-59	25	8.20	P12B2-59	25	22.55	P12B3-59	30	36.82
60	363.99	373.0	P12B1-60	25	8.48	P12B2-60	25	23.35	P12B3-60	30	38.13
62	376.12	385.1	P12B1-62	25	9.07	P12B2-62	30	24.93	P12B3-62	30	40.80
64	388.24	397.2	P12B1-64	25	9.68	P12B2-64	30	26.62	P12B3-64	30	43.57
65	394.29	403.2	P12B1-65	25	9.99	P12B2-65	30	27.48	P12B3-65	30	44.99
66	400.35	409.3	P12B1-66	30	10.29	P12B2-66	30	28.36	P12B3-66	30	46.43
68	412.49	421.4	P12B1-68	30	10.93	P12B2-68	30	30.16	P12B3-68	30	49.38
70	424.60	433.6	P12B1-70	30	11.60	P12B2-70	30	32.01	P12B3-70	30	52.42
72	436.74	447.0	P12B1-72	30	12.28	P12B2-72	30	33.92	P12B3-72	30	55.55
75	454.91	463.9	P12B1-75	30	13.35	P12B2-75	30	36.88	P12B3-75	30	60.42
76	460.99	469.9	P12B1-76	30	13.71	P12B2-76	30	37.90	P12B3-76	30	62.08
78	473.10	482.1	P12B1-78	30	14.46	P12B2-78	30	39.97	P12B3-78	30	65.48
80	485.22	494.2	P12B1-80	30	15.22	P12B2-80	30	42.10	P12B3-80	30	68.98
85	515.55	524.5	P12B1-85	30	17.22	P12B2-85	30	47.66	P12B3-85	30	78.10
90	545.86	554.8	P12B1-90	30	19.34	P12B2-90	30	53.56	P12B3-90	30	87.79
95	576.17	585.1	P12B1-95	30	21.58	P12B2-95	30	59.81	P12B3-95	30	98.04
100	606.47	615.4	P12B1-100	30	23.94	P12B2-100	30	66.40	P12B3-100	30	108.86
110	667.11	676.1	P12B1-110	30	29.03	P12B2-110	30	80.61	P12B3-110	30	132.19
114	691.36	700.6	P12B1-114	30	31.21	P12B2-114	30	86.68	P12B3-114	30	142.15
120	727.74	736.7	P12B1-120	30	34.61	P12B2-120	30	96.19	P12B3-120	30	157.77
125	758.05	767.0	P12B1-125	30	37.59	P12B2-125	30	104.50	P12B3-125	30	171.41

All dimensions in mm.
Stock Platewheels can be reworked to customers bore and keyway requirements, on 48 hour service.
Platewheels manufactured in steel 8 to 30 tooth with a minimum U.T.S. 600N/mm² - Above 30T - 410N/mm²
Platewheels 8 to 30 tooth can be supplied with teeth induction hardened to 45Rc.

Tel +44(0) 121 360 0155 Fax +44(0) 121 325 1079 Email sales@crossmorse.com

Standard Platewheels for 1" Pitch British Standard Chain Type 16B



Platewheels for Simplex Chain 16B-1 Conforming to ISO 606

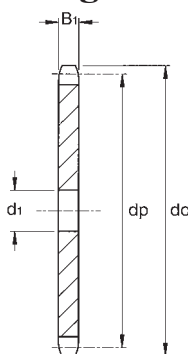

Chain No: 16B-1
Pitch 25.40mm
Roller Dia. 15.88mm
Inside Width 17.02mm
Overall Width 38.7mm
Tooth Width B₁ 16.2mm

Platewheels for Duplex Chain 16B-2 Conforming to ISO 606

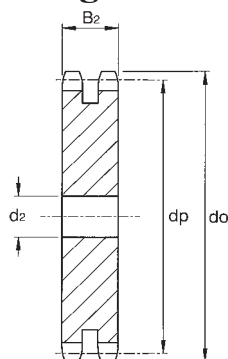

Chain No: 16B-2
Pitch 25.40mm
Roller Dia. 15.88mm
Inside Width 17.02mm
Overall Width 70.7mm
Tooth Width B₂ 47.7mm

Platewheels for Triplex Chain 16B-3 Conforming to ISO 606

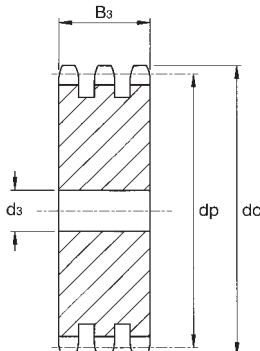

Chain No: 16B-3
Pitch 25.40mm
Roller Dia. 15.88mm
Inside Width 17.02mm
Overall Width 102.5mm
Tooth Width B₃ 79.6mm

No. Teeth	Pitch Circle Ø dp	Outside Ø do	Platewheel for 16B-1 Chain			Platewheel for 16B-2 Chain			Platewheel for 16B-3 Chain		
			Cat. No.	Min. Bore d ₁	Approx. Weight kg	Cat. No.	Min. Bore d ₂	Approx. Weight kg	Cat. No.	Min. Bore d ₃	Approx. Weight kg
8	66.37	77.0	P16B1-08	14	.28	P16B2-08	16	.71	P16B3-08	20	1.12
9	74.27	85.0	P16B1-09	14	.38	P16B2-09	16	.97	P16B3-09	20	1.55
10	82.19	93.0	P16B1-10	15	.48	P16B2-10	16	1.27	P16B3-10	20	2.04
11	90.14	99.5	P16B1-11	16	.60	P16B2-11	20	1.57	P16B3-11	20	2.53
12	98.14	109.0	P16B1-12	16	.73	P16B2-12	20	1.94	P16B3-12	20	3.15
13	106.12	117.0	P16B1-13	16	.88	P16B2-13	20	2.36	P16B3-13	20	3.83
14	114.15	125.0	P16B1-14	16	1.03	P16B2-14	20	2.81	P16B3-14	20	4.58
15	122.17	133.0	P16B1-15	16	1.20	P16B2-15	20	3.30	P16B3-15	20	5.39
16	130.20	141.0	P16B1-16	20	1.37	P16B2-16	20	3.84	P16B3-16	30	6.16
17	138.22	149.0	P16B1-17	20	1.56	P16B2-17	20	4.40	P16B3-17	30	7.10
18	146.28	157.0	P16B1-18	20	1.77	P16B2-18	20	5.01	P16B3-18	30	8.10
19	154.33	165.2	P16B1-19	20	1.99	P16B2-19	20	5.66	P16B3-19	30	9.17
20	162.38	173.0	P16B1-20	20	2.22	P16B2-20	20	6.34	P16B3-20	30	10.31
21	170.43	181.2	P16B1-21	20	2.46	P16B2-21	25	7.00	P16B3-21	30	11.50
22	178.48	189.3	P16B1-22	20	2.72	P16B2-22	25	7.76	P16B3-22	30	12.76
23	186.53	197.5	P16B1-23	20	2.99	P16B2-23	25	8.56	P16B3-23	30	14.09
24	194.59	205.5	P16B1-24	20	3.27	P16B2-24	25	9.40	P16B3-24	30	15.48
25	202.66	213.5	P16B1-25	20	3.57	P16B2-25	25	10.28	P16B3-25	30	16.93
26	210.72	221.6	P16B1-26	20	3.85	P16B2-26	25	11.19	P16B3-26	30	18.32
27	218.79	229.6	P16B1-27	20	4.17	P16B2-27	25	12.15	P16B3-27	30	19.90
28	226.85	237.7	P16B1-28	20	4.50	P16B2-28	25	13.14	P16B3-28	30	21.55
29	234.92	245.8	P16B1-29	20	4.84	P16B2-29	25	14.17	P16B3-29	30	23.26
30	243.00	254.0	P16B1-30	20	5.20	P16B2-30	25	15.24	P16B3-30	30	25.03
31	251.08	262.0	P16B1-31	25	5.57	P16B2-31	25	16.35	P16B3-31	30	26.87
32	259.13	270.0	P16B1-32	25	5.95	P16B2-32	25	17.49	P16B3-32	30	28.78
33	267.21	278.5	P16B1-33	25	6.34	P16B2-33	25	18.68	P16B3-33	30	30.74
34	275.28	287.0	P16B1-34	25	6.75	P16B2-34	25	19.90	P16B3-34	30	32.77
35	283.36	296.2	P16B1-35	25	7.17	P16B2-35	25	21.16	P16B3-35	30	34.87
36	291.44	304.6	P16B1-36	25	7.60	P16B2-36	25	22.46	P16B3-36	30	37.03
37	299.51	312.6	P16B1-37	25	8.04	P16B2-37	25	23.80	P16B3-37	30	39.25
38	307.59	320.7	P16B1-38	25	8.50	P16B2-38	25	25.17	P16B3-38	30	41.54
39	315.67	328.8	P16B1-39	25	8.97	P16B2-39	25	26.59	P16B3-39	30	43.89
40	323.75	336.9	P16B1-40	25	9.45	P16B2-40	25	28.04	P16B3-40	30	46.31
41	331.82	345.0	P16B1-41	25	9.94						
42	339.90	353.0	P16B1-42	25	10.45	P16B2-42	25	31.06	P16B3-42	30	51.33
43	347.98	361.1	P16B1-43	25	10.97	P16B2-43	25	32.63			
44	356.05	369.1	P16B1-44	25	11.50	P16B2-44	25	34.24	P16B3-44	30	56.62
45	364.13	377.1	P16B1-45	25	12.04	P16B2-45	25	35.89	P16B3-45	30	59.35
46	372.21	385.2	P16B1-46	25	12.60	P16B2-46	30	37.49	P16B3-46	30	62.15
47	380.29	393.2	P16B1-47	25	13.17						
48	388.36	401.3	P16B1-48	25	13.75	P16B2-48	30	40.97	P16B3-48	30	67.95
49	396.44	409.3	P16B1-49	25	14.34						
50	404.52	417.4	P16B1-50	25	14.95	P16B2-50	30	44.61	P16B3-50	30	74.00
51	412.60	425.5	P16B1-51	30	15.54	P16B2-51	30	46.49	P16B3-51	40	76.78
52	420.67	433.6	P16B1-52	30	16.17	P16B2-52	30	48.40	P16B3-52	40	79.97
53	428.75	441.7	P16B1-53	30	16.82						
54	436.85	448.3	P16B1-54	30	17.47						
55	444.93	457.9	P16B1-55	30	18.14	P16B2-55	30	54.38	P16B3-55	40	89.91
56	453.01	466.0	P16B1-56	30	18.82	P16B2-56	40	56.24			
57	461.07	474.0	P16B1-57	30	19.52	P16B2-57	40	58.35	P16B3-57	40	96.86
58	469.16	482.1	P16B1-58	30	20.22						
59	477.24	490.2	P16B1-59	30	20.94						
60	485.32	498.3	P16B1-60	30	21.67	P16B2-60	40	64.90	P16B3-60	40	107.80
62	501.50	514.5	P16B1-62	30	23.17	P16B2-62	40	69.46			
64	517.65	530.7	P16B1-64	30	24.72						
65	525.73	538.8	P16B1-65	30	25.52	P16B2-65	40	76.59	P16B3-65	40	127.20
66	533.80	546.8	P16B1-66	30	26.32						
68	549.98	562.9	P16B1-68	30	27.97	P16B2-68	40	84.07	P16B3-68	40	139.70
70	566.14	579.2	P16B1-70	30	29.67	P16B2-70	40	89.24	P16B3-70	40	148.30
72	582.32	595.4	P16B1-72	30	31.42	P16B2-72	40	94.57	P16B3-72	40	157.20
75	606.55	619.7	P16B1-75	30	34.14	P16B2-75	40	102.85	P16B3-75	40	171.00
76	614.65	627.0	P16B1-76	30	35.07	P16B2-76	40	105.70	P16B3-76	40	175.70
78	630.80	643.3	P16B1-78	30	36.97						
80	646.96	660.0	P16B1-80	30	38.92	P16B2-80	40	117.40	P16B3-80	40	195.20
85	687.40	699.9	P16B1-85	30	44.01	P16B2-85	40	133.00	P16B3-85	40	221.10
90	727.81	740.3	P16B1-90	30	49.41	P16B2-90	40	149.50	P16B3-90	40	248.60
95	768.22	781.1	P16B1-95	30	55.13	P16B2-95	40	166.90	P16B3-95	40	277.70
100	808.63	821.1	P16B1-100	30	66.16	P16B2-100	40	185.30	P16B3-100	40	308.40
110	889.48	902.0	P16B1-110	30	74.16	P16B2-110	40	225.00	P16B3-110	40	374.60
114	921.81	934.3	P16B1-114	30	79.70	P16B2-114	40	242.00	P16B3-114	40	402.80
120	970.33	982.8	P16B1-120	30	88.40	P16B2-120	40	268.60	P16B3-120	40	447.20
125	1010.73	1023.2	P16B1-125	30	95.99	P16B2-125	40	291.80	P16B3-125	40	485.90

All dimensions in mm.
Stock Platewheels can be reworked to customers bore and keyway requirements, on 48 hour service.
Platewheels manufactured in steel 8 to 21 tooth with a minimum U.T.S. 600N/mm² - Above 21T - 410N/mm²
Platewheels 8 to 21 tooth can be supplied with teeth induction hardened to 45Rc.

Tel +44(0) 121 360 0155 Fax +44(0) 121 325 1079 Email sales@crossmorse.com

Standard Platewheels for 1 1/4" Pitch British Standard Chain Type 20B



Platewheels for Simplex Chain 20B-1 Conforming to ISO 606

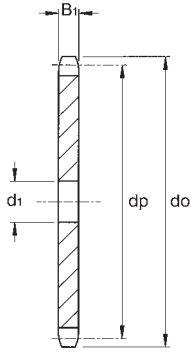

Chain No: 20B-1
Pitch 31.75mm
Roller Dia. 19.05mm
Inside Width 19.56mm
Overall Width 44.1mm
Tooth Width B₁ 18.5mm

Platewheels for Duplex Chain 20B-2 Conforming to ISO 606

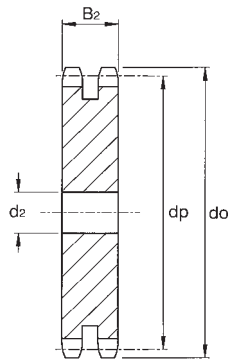

Chain No: 20B-2
Pitch 31.75mm
Roller Dia. 19.05mm
Inside Width 19.56mm
Overall Width 80.5mm
Tooth Width B₂ 54.6mm

Platewheels for Triplex Chain 20B-3 Conforming to ISO 606

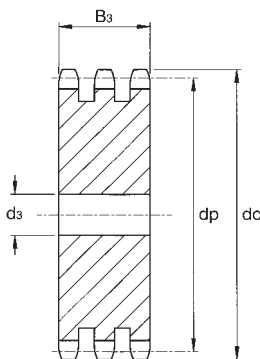

Chain No: 20B-3
Pitch 31.75mm
Roller Dia. 19.05mm
Inside Width 19.56mm
Overall Width 117.1mm
Tooth Width B₃ 91.0mm

No. Teeth	Pitch Circle Ø dp	Outside Ø do	Platewheel for 20B-1 Chain			Platewheel for 20B-2 Chain			Platewheel for 20B-3 Chain		
			Cat. No.	Min. Bore d _i	Approx. Weight kg	Cat. No.	Min. Bore d _i	Approx. Weight kg	Cat. No.	Min. Bore d _i	Approx. Weight kg
8	82.96	98.1	P20B1-08	16	0.5	P20B2-08	20	1.3	P20B3-08	20	2.0
9	92.84	108.0	P20B1-09	16	0.7	P20B2-09	20	1.7	P20B3-09	20	2.8
10	102.74	117.9	P20B1-10	16	0.9	P20B2-10	20	2.3	P20B3-10	20	3.6
11	112.68	127.8	P20B1-11	20	1.1	P20B2-11	20	2.9	P20B3-11	25	4.5
12	122.68	137.8	P20B1-12	20	1.3	P20B2-12	20	3.5	P20B3-12	25	5.6
13	132.65	147.8	P20B1-13	20	1.6	P20B2-13	20	4.3	P20B3-13	25	6.8
14	142.68	157.8	P20B1-14	20	1.9	P20B2-14	20	5.1	P20B3-14	25	8.2
15	152.72	167.9	P20B1-15	20	2.2	P20B2-15	20	6.0	P20B3-15	25	9.6
16	162.75	177.9	P20B1-16	25	2.5	P20B2-16	30	6.8	P20B3-16	30	11.0
17	172.78	187.9	P20B1-17	25	2.9	P20B2-17	30	7.8	P20B3-17	30	12.7
18	182.85	198.0	P20B1-18	25	3.2	P20B2-18	30	8.9	P20B3-18	30	14.5
19	192.91	208.1	P20B1-19	25	3.6	P20B2-19	30	10.0	P20B3-19	30	16.4
20	202.98	218.1	P20B1-20	25	4.1	P20B2-20	30	11.2	P20B3-20	30	18.4
21	213.04	228.2	P20B1-21	25	4.5	P20B2-21	30	12.5	P20B3-21	30	20.6
22	223.11	238.3	P20B1-22	25	5.0	P20B2-22	30	13.9	P20B3-22	30	22.8
23	233.17	248.3	P20B1-23	25	5.5	P20B2-23	30	15.3	P20B3-23	30	25.2
24	243.23	258.4	P20B1-24	25	6.0	P20B2-24	30	16.8	P20B3-24	30	27.7
25	253.33	268.5	P20B1-25	25	6.5	P20B2-25	30	18.4	P20B3-25	30	30.3
26	263.40	278.6	P20B1-26	30	7.0	P20B2-26	30	20.0	P20B3-26	30	33.0
27	273.40	288.6	P20B1-27	30	7.6	P20B2-27	30	21.7	P20B3-27	30	35.8
28	283.56	298.7	P20B1-28	30	8.2	P20B2-28	30	23.5	P20B3-28	30	38.7
29	293.65	308.8	P20B1-29	30	8.8	P20B2-29	30	25.3	P20B3-29	30	41.8
30	303.75	318.9	P20B1-30	30	9.5	P20B2-30	30	27.2	P20B3-30	30	45.0
31	313.85	329.0	P20B1-31	30	10.1	P20B2-31	30	29.2	P20B3-31	30	48.3
32	323.91	339.1	P20B1-32	30	10.8	P20B2-32	30	31.2	P20B3-32	30	51.7
33	334.01	349.2	P20B1-33	30	11.5	P20B2-33	30	33.4	P20B3-33	30	55.2
34	344.10	359.3	P20B1-34	30	12.3	P20B2-34	30	35.5	P20B3-34	30	58.8
35	354.20	369.4	P20B1-35	30	13.0	P20B2-35	30	37.8	P20B3-35	30	62.5
36	364.30	379.5	P20B1-36	30	13.8	P20B2-36	30	40.1	P20B3-36	30	66.4
37	374.39	389.5	P20B1-37	30	14.6	P20B2-37	30	42.5	P20B3-37	30	70.4
38	384.49	399.6	P20B1-38	30	15.5	P20B2-38	30	45.0	P20B3-38	30	74.4
39	394.59	409.7	P20B1-39	30	16.3	P20B2-39	30	47.5	P20B3-39	30	78.7
40	404.68	419.8	P20B1-40	30	17.2	P20B2-40	30	50.1	P20B3-40	30	83.0
41	414.78	429.9	P20B1-41	30	18.1						
42	424.88	440.0	P20B1-42	30	19.0	P20B2-42	30	55.5	P20B3-42	40	91.5
43	434.97	450.1	P20B1-43	30	19.9						
44	445.07	460.2	P20B1-44	30	20.9						
45	455.17	470.3	P20B1-45	30	21.9	P20B2-45	30	64.1	P20B3-45	40	105.9
46	465.26	480.4	P20B1-46	30	22.9	P20B2-46	30	67.1	P20B3-46	40	110.9
47	475.36	490.5	P20B1-47	30	23.9						
48	485.46	500.6	P20B1-48	30	25.0	P20B2-48	30	73.3	P20B3-48	40	121.2
49	495.55	510.7	P20B1-49	30	26.1						
50	505.65	520.8	P20B1-50	30	27.2	P20B2-50	30	79.8	P20B3-50	40	132.0
51	515.75	530.9	P20B1-51	30	28.3						
52	525.84	541.0	P20B1-52	30	29.4	P20B2-52	40	86.3	P20B3-52	40	143.3
53	535.94	551.1	P20B1-53	30	30.6						
54	546.07	561.2	P20B1-54	30	31.8						
55	556.16	571.3	P20B1-55	30	33.0	P20B2-55	40	97.0	P20B3-55	40	161.1
56	566.26	581.4	P20B1-56	30	34.3						
57	576.36	591.5	P20B1-57	30	35.5	P20B2-57	40	104.5	P20B3-57	40	173.5
58	586.45	601.6	P20B1-58	30	36.8						
59	596.55	611.7	P20B1-59	30	38.1						
60	606.65	621.8	P20B1-60	30	39.4	P20B2-60	40	116.2	P20B3-60	40	192.9
62	626.87	642.0	P20B1-62	30	42.2						
64	647.06	662.2	P20B1-64	30	45.0						
65	657.16	672.3	P20B1-65	30	46.4	P20B2-65	40	137.0	P20B3-65	40	227.7
66	667.26	682.4	P20B1-66	30	47.9						
68	687.48	702.6	P20B1-68	30	50.9						
70	707.67	722.8	P20B1-70	30	53.9	P20B2-70	40	159.6	P20B3-70	40	265.3
72	727.90	743.1	P20B1-72	30	57.1						
75	758.19	773.3	P20B1-75	30	62.1						
76	768.32	783.5	P20B1-76	30	63.8	P20B2-76	40	189.0	P20B3-76	40	314.3
80	808.72	823.9	P20B1-80	30	70.7	P20B2-80	40	209.9	P20B3-80	40	349.2
85	859.25	874.4	P20B1-85	30	80.0						
90	909.76	924.9	P20B1-90	30	89.8						
95	960.28	975.4	P20B1-95	30	100.2	P20B2-95	40	298.3	P20B3-95	40	496.4
100	1010.79	1026.0	P20B1-100	40	111.1						
114	1152.26	1167.4	P20B1-114	40	144.7	P20B2-114	40	423.3	P20B3-114	40	720.0

All dimensions in mm.

Stock Platewheels can be reworked to customers bore and keyway requirements, on 48 hour service.
Platewheels manufactured in steel 8 to 21 tooth with a minimum U.T.S. 600N/mm² - Above 21T - 410N/mm²
Platewheels 8 to 21 tooth can be supplied with teeth induction hardened to 45Rc.

Standard Platewheels for 1½" Pitch British Standard Chain Type 24B



Platewheels for Simplex Chain 24B-1 Conforming to ISO 606

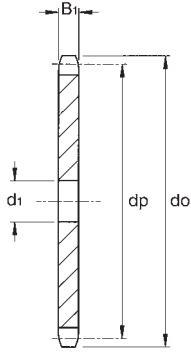

Chain No: 24B-1
Pitch 38.10mm
Roller Dia. 25.40mm
Inside Width 25.40mm
Overall Width 56.9mm
Tooth Width B₁ 24.1mm

Platewheels for Duplex Chain 24B-2 Conforming to ISO 606

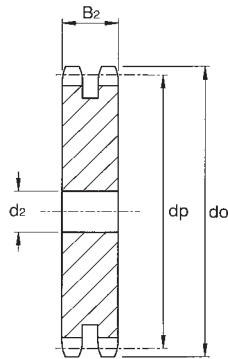

Chain No: 24B-2
Pitch 38.10mm
Roller Dia. 25.40mm
Inside Width 25.40mm
Overall Width 105.0mm
Tooth Width B₂ 72.0mm

Platewheels for Triplex Chain 24B-3 Conforming to ISO 606

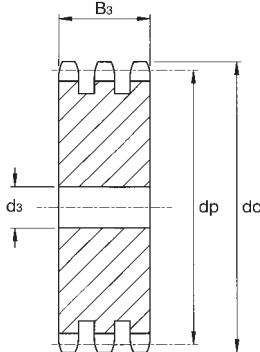

Chain No: 24B-3
Pitch 38.10mm
Roller Dia. 25.40mm
Inside Width 25.40mm
Overall Width 153.0mm
Tooth Width B₃ 120.3mm

No. Teeth	Pitch Circle Ø dp	Outside Ø do	Platewheel for 24B-1 Chain			Platewheel for 24B-2 Chain			Platewheel for 24B-3 Chain		
			Cat. No.	Min. Bore d ₁	Approx. Weight kg	Cat. No.	Min. Bore d ₂	Approx. Weight kg	Cat. No.	Min. Bore d ₃	Approx. Weight kg
8	99.55	115.0	P24B1-08	20	1.0	P24B2-08	25	2.3	P24B3-08	25	3.6
9	111.40	126.4	P24B1-09	20	1.3	P24B2-09	25	3.1	P24B3-09	25	5.0
10	123.29	138.0	P24B1-10	20	1.6	P24B2-10	25	4.1	P24B3-10	25	6.7
11	135.21	150.0	P24B1-11	25	2.0	P24B2-11	25	5.2	P24B3-11	30	8.3
12	147.22	162.0	P24B1-12	25	2.4	P24B2-12	25	6.5	P24B3-12	30	10.4
13	159.18	174.2	P24B1-13	25	2.9	P24B2-13	25	7.9	P24B3-13	30	12.7
14	171.22	186.2	P24B1-14	25	3.4	P24B2-14	25	9.4	P24B3-14	30	15.2
15	183.26	198.2	P24B1-15	25	4.0	P24B2-15	25	11.0	P24B3-15	30	17.9
16	195.30	210.3	P24B1-16	25	4.6	P24B2-16	30	12.7	P24B3-16	30	20.8
17	207.34	222.3	P24B1-17	25	5.2	P24B2-17	30	14.6	P24B3-17	30	24.0
18	219.42	234.3	P24B1-18	25	5.9	P24B2-18	30	16.6	P24B3-18	30	27.3
19	231.49	246.5	P24B1-19	25	6.6	P24B2-19	30	18.8	P24B3-19	30	30.9
20	243.57	258.6	P24B1-20	25	7.4	P24B2-20	30	21.0	P24B3-20	30	34.7
21	255.65	270.6	P24B1-21	30	8.2	P24B2-21	30	23.5	P24B3-21	40	38.2
22	267.73	282.7	P24B1-22	30	9.1	P24B2-22	30	26.0	P24B3-22	40	42.5
23	279.80	294.8	P24B1-23	30	10.0	P24B2-23	30	28.7	P24B3-23	40	46.9
24	291.88	306.8	P24B1-24	30	10.9	P24B2-24	30	31.5	P24B3-24	40	51.6
25	304.00	319.0	P24B1-25	30	11.9	P24B2-25	30	34.4	P24B3-25	40	56.5
26	316.08	331.0	P24B1-26	30	12.9	P24B2-26	30	37.5	P24B3-26	40	61.6
27	328.19	343.2	P24B1-27	30	13.9	P24B2-27	30	40.7	P24B3-27	40	66.9
28	340.27	355.2	P24B1-28	30	15.0	P24B2-28	30	44.0	P24B3-28	40	72.5
29	352.38	367.3	P24B1-29	30	16.2	P24B2-29	30	47.4	P24B3-29	40	78.2
30	364.50	379.5	P24B1-30	30	17.4	P24B2-30	30	51.0	P24B3-30	40	84.2
31	376.62	391.6	P24B1-31	30	18.6	P24B2-31	40	54.4	P24B3-31	40	90.8
32	388.69	403.7	P24B1-32	30	19.8	P24B2-32	40	58.3	P24B3-32	40	96.8
33	400.81	415.8	P24B1-33	30	21.2	P24B2-33	40	62.2	P24B3-33	40	103.4
34	412.93	427.8	P24B1-34	30	22.5	P24B2-34	40	66.3	P24B3-34	40	110.2
35	425.04	440.0	P24B1-35	30	23.9	P24B2-35	40	70.5	P24B3-35	40	117.3
36	437.16	452.0	P24B1-36	30	25.3	P24B2-36	40	74.9	P24B3-36	40	124.6
37	449.27	464.2	P24B1-37	30	26.8	P24B2-37	40	79.4	P24B3-37	40	132.1
38	461.39	476.2	P24B1-38	30	28.3	P24B2-38	40	84.0	P24B3-38	40	139.8
39	473.50	488.5	P24B1-39	30	29.9	P24B2-39	40	88.7	P24B3-39	40	147.7
40	485.62	500.6	P24B1-40	30	31.5	P24B2-40	40	93.6	P24B3-40	40	155.8
41	497.74	512.6	P24B1-41	30	33.2						
42	509.85	524.7	P24B1-42	30	34.8	P24B2-42	40	103.7	P24B3-42	40	172.8
43	521.97	536.8	P24B1-43	30	36.6						
44	534.08	549.0	P24B1-44	30	38.3						
45	546.20	561.2	P24B1-45	30	40.2	P24B2-45	40	119.9	P24B3-45	40	199.8
46	558.32	573.3	P24B1-46	30	42.0	P24B2-46	40	125.6	P24B3-46	40	209.2
47	570.43	585.4	P24B1-47	30	43.9						
48	582.55	597.4	P24B1-48	30	45.8	P24B2-48	40	137.3	P24B3-48	40	228.8
49	594.66	609.5	P24B1-49	30	47.8						
50	606.78	621.7	P24B1-50	30	49.8	P24B2-50	40	149.5	P24B3-50	40	249.2
51	618.89	633.8	P24B1-51	30	51.9						
52	631.01	646.0	P24B1-52	30	54.0						
53	643.13	658.0	P24B1-53	30	56.2						
54	655.28	670.2	P24B1-54	30	58.3						
55	667.40	682.3	P24B1-55	30	60.6	P24B2-55	40	182.2	P24B3-55	40	304.0
56	679.51	694.4	P24B1-56	30	62.8						
57	691.63	706.5	P24B1-57	30	65.2	P24B2-57	40	196.2	P24B3-57	40	327.4
58	703.74	718.6	P24B1-58	30	67.5						
59	715.86	730.7	P24B1-59	30	69.9						
60	727.97	742.8	P24B1-60	30	72.3	P24B2-60	40	218.2	P24B3-60	40	364.2
62	752.24	767.2	P24B1-62	40	77.2						
64	776.48	791.3	P24B1-64	40	82.4						
65	788.59	803.4	P24B1-65	40	85.1	P24B2-65	40	257.5	P24B3-65	40	429.9
66	800.71	815.6	P24B1-66	40	87.8						
68	824.98	839.8	P24B1-68	40	93.3						
70	849.21	864.2	P24B1-70	40	98.9						
72	873.48	888.4	P24B1-72	40	104.8						
75	909.83	924.8	P24B1-75	40	113.8						
76	921.98	939.9	P24B1-76	40	116.9	P24B2-76	40	355.1	P24B3-76	40	593.4
80	970.44	985.7	P24B1-80	40	129.8						
85	1031.10	1046.0	P24B1-85	40	146.8						
95	1152.33	1167.0	P24B1-95	40	183.9						

All dimensions in mm.
Stock Platewheels can be reworked to customers bore and keyway requirements, on 48 hour service.
Platewheels manufactured in steel 8 to 21 tooth with a minimum U.T.S. 600N/mm² - Above 21T - 410N/mm²
Platewheels 8 to 21 tooth can be supplied with teeth induction hardened to 45Rc.

Tel +44(0) 121 360 0155

Fax +44(0) 121 325 1079

Email sales@crossmorse.com

Standard Platewheels for 1³/₄" & 2" Pitch B.S. Chains Types 28B & 32B



Platewheels for Simplex Chains Conforming to ISO 606 28B - 1³/₄" Pitch Platewheel

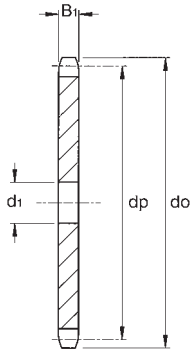

Chain No:	28B-1	32B-1
Pitch	44.45mm	50.8mm
Roller Dia.	27.94mm	29.21mm
Inside Width	30.99mm	30.99mm
Overall Width	71.3mm	68.6mm
Tooth Width B ₁	29.4mm	29.4mm

Platewheels for Duplex Chain Conforming to ISO 606

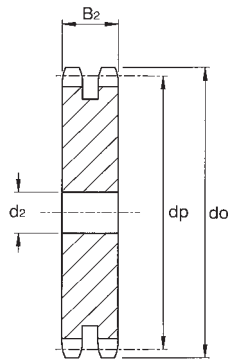

Chain No:	28B-2	32B-2
Pitch	44.45mm	50.8mm
Roller Dia.	27.94mm	29.21mm
Inside Width	30.99mm	30.99mm
Overall Width	130.3mm	126.8mm
Tooth Width B ₂	88.4mm	87.4mm

Platewheels for Triplex Chain Conforming to ISO 606

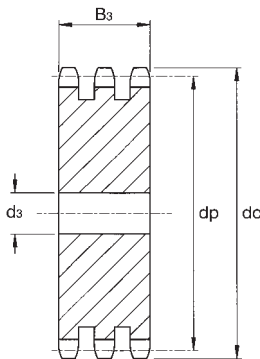

Chain No:	28B-3	32B-3
Pitch	44.45mm	50.8mm
Roller Dia.	27.94mm	29.21mm
Inside Width	30.99mm	30.99mm
Overall Width	189.9mm	185.0mm
Tooth Width B ₃	148.0mm	146.0mm

No. Teeth	Pitch Circle Ø dp	Outside Ø do	Platewheel for 28B-1 Chain			Platewheel for 28B-2 Chain			Platewheel for 28B-3 Chain		
			Cat. No.	Min. Bore d ₁	Approx. Weight kg	Cat. No.	Min. Bore d ₂	Approx. Weight kg	Cat. No.	Min. Bore d ₃	Approx. Weight kg
8	116.15	132.0	P28B1-08	25	1.7	P28B2-08	25	3.9	P28B3-08	25	6.1
9	129.96	148.4	P28B1-09	25	2.3	P28B2-09	25	5.6	P28B3-09	25	8.8
10	143.85	162.3	P28B1-10	25	2.9	P28B2-10	25	7.2	P28B3-10	25	11.5
11	157.77	176.3	P28B1-11	25	3.6	P28B2-11	30	9.0	P28B3-11	30	14.4
12	171.74	189.5	P28B1-12	25	4.3	P28B2-12	30	11.0	P28B3-12	30	17.7
13	185.75	204.2	P28B1-13	25	5.2	P28B2-13	30	13.4	P28B3-13	30	21.7
14	199.76	218.2	P28B1-14	25	6.1	P28B2-14	30	15.9	P28B3-14	30	25.8
15	213.79	232.3	P28B1-15	25	7.1	P28B2-15	30	18.7	P28B3-15	30	30.4
16	227.84	246.3	P28B1-16	30	8.1	P28B2-16	30	21.6	P28B3-16	30	35.3
17	241.91	260.0	P28B1-17	30	9.1	P28B2-17	30	24.8	P28B3-17	30	40.5
18	255.98	274.0	P28B1-18	30	10.3	P28B2-18	30	28.2	P28B3-18	30	46.2
19	270.06	289.0	P28B1-19	30	11.7	P28B2-19	30	32.0	P28B3-19	30	52.5
20	284.15	303.0	P28B1-20	30	13.0	P28B2-20	30	35.8	P28B3-20	30	58.8
21	298.24	317.0	P28B1-21	30	14.4	P28B2-21	30	39.9	P28B3-21	40	64.9
22	312.34	331.0	P28B1-22	30	15.9	P28B2-22	30	44.1	P28B3-22	40	72.0
23	326.44	345.0	P28B1-23	30	17.4	P28B2-23	30	48.6	P28B3-23	40	79.5
24	340.55	359.0	P28B1-24	30	19.0	P28B2-24	30	53.3	P28B3-24	40	87.3
25	354.66	373.0	P28B1-25	30	20.7	P28B2-25	30	58.2	P28B3-25	40	95.5
26	368.77	387.0	P28B1-26	30	22.4	P28B2-26	30	63.4	P28B3-26	40	104.0
27	382.88	401.0	P28B1-27	30	24.3	P28B2-27	30	68.8	P28B3-27	40	113.1
28	397.00	416.0	P28B1-28	30	26.3	P28B2-28	30	74.6	P28B3-28	40	122.6
29	411.12	430.0	P28B1-29	30	28.2	P28B2-29	30	80.4			
30	425.24	444.0	P28B1-30	30	30.3	P28B2-30	30	86.4	P28B3-30	40	142.2
31	439.37	458.0	P28B1-31	30	32.4						
32	453.49	472.0	P28B1-32	30	34.5						
33	467.62	486.0	P28B1-33	30	36.8						
34	481.75	500.0	P28B1-34	30	39.1						
35	495.88	514.0	P28B1-35	30	41.5	P28B2-35	40	119.2	P28B3-35	40	197.6
36	510.01	529.0	P28B1-36	30	44.1						
37	524.14	543.0	P28B1-37	30	46.7						
38	538.27	557.0	P28B1-38	30	49.3	P28B2-38	40	142.1	P28B3-38	40	235.8
39	552.40	571.0	P28B1-39	30	52.0						
40	566.54	585.0	P28B1-40	30	54.7	P28B2-40	40	158.3	P28B3-40	40	262.7
45	637.22	656.0	P28B1-45	30	69.7	P28B2-45	40	202.8	P28B3-45	40	336.9
50	707.91	726.0	P28B1-50	30	86.3	P28B2-50	40	252.3	P28B3-50	40	419.5
57	806.90	825.0	P28B1-57	40	112.6	P28B2-57	40	331.2	P28B3-57	40	551.2
60	849.32	869.0	P28B1-60	40	125.5	P28B2-60	40	369.2	P28B3-60	40	614.6
76	1075.62	1095.0	P28B1-76	40	202.8	P28B2-76	40	600.2	P28B3-76	40	1000.4

32B - 2" Pitch Platewheel

No. Teeth	Pitch Circle Ø dp	Outside Ø do	Platewheel for 32B-1 Chain			Platewheel for 32B-2 Chain			Platewheel for 32B-3 Chain		
			Cat. No.	Min. Bore d ₁	Approx. Weight kg	Cat. No.	Min. Bore d ₂	Approx. Weight kg	Cat. No.	Min. Bore d ₃	Approx. Weight kg
8	132.75	153.2	P32B1-08	25	2.6	P32B2-08	25	5.8	P32B3-08	25	9.3
9	148.53	169.0	P32B1-09	25	3.4	P32B2-09	25	7.7	P32B3-09	25	12.5
10	164.39	185.0	P32B1-10	25	4.2	P32B2-10	25	10.0	P32B3-10	25	16.1
11	180.31	200.8	P32B1-11	30	5.1	P32B2-11	35	12.5	P32B3-11	35	20.2
12	196.28	216.8	P32B1-12	30	6.1	P32B2-12	35	15.2	P32B3-12	35	24.7
13	212.27	232.8	P32B1-13	30	7.2	P32B2-13	35	18.3	P32B3-13	35	29.8
14	228.29	248.8	P32B1-14	30	8.5	P32B2-14	35	21.7	P32B3-14	35	35.3
15	244.33	264.8	P32B1-15	30	9.7	P32B2-15	35	25.3	P32B3-15	35	41.2
16	260.39	280.9	P32B1-16	30	11.1	P32B2-16	40	29.2	P32B3-16	40	47.7
17	276.46	296.9	P32B1-17	30	12.6	P32B2-17	40	33.4	P32B3-17	40	54.6
18	292.55	313.0	P32B1-18	30	14.2	P32B2-18	40	37.9	P32B3-18	40	62.0
19	308.64	329.1	P32B1-19	30	15.9	P32B2-19	40	42.6	P32B3-19	40	69.9
20	324.74	345.2	P32B1-20	30	17.7	P32B2-20	40	47.7	P32B3-20	40	78.2
21	340.84	361.3	P32B1-21	40	19.5	P32B2-21	40	53.0	P32B3-21	40	87.0
22	356.96	377.5	P32B1-22	40	21.5	P32B2-22	40	58.6	P32B3-22	40	96.4
23	373.07	393.6	P32B1-23	40	23.5	P32B2-23	40	64.5	P32B3-23	40	106.1
24	389.19	409.7	P32B1-24	40	25.7	P32B2-24	40	70.7	P32B3-24	40	116.3
25	405.32	425.8	P32B1-25	40	27.9	P32B2-25	40	77.1	P32B3-25	40	127.0
26	421.45	441.9	P32B1-26	40	30.3	P32B2-26	40	83.9	P32B3-26	40	138.2
27	437.58	458.1	P32B1-27	40	32.7	P32B2-27	40	90.9	P32B3-27	40	149.8
28	453.72	474.2	P32B1-28	40	35.2	P32B2-28	40	98.2	P32B3-28	40	161.9
29	469.85	490.4	P32B1-29	40	37.8	P32B2-29	40	105.8	P32B3-29	40	174.5
30	485.99	506.5	P32B1-30	40	40.5	P32B2-30	40	113.6	P32B3-30	40	187.6
32	518.28	538.8	P32B1-32	40	46.3	P32B2-32	40	130.2	P32B3-32	40	215.1
35	566.72	589.5	P32B1-35	40	56.0	P32B2-35	40	158.1	P32B3-35	40	261.3
38	615.17	635.5	P32B1-38	40	65.6	P32B2-38	40	186.6	P32B3-38	40	308.8
40	647.47	670.3	P32B1-40	40	73.4	P32B2-40	40	208.9	P32B3-40	40	345.7
45	728.25	751.0	P32B1-45	40	93.1	P32B2-45	40	266.6	P32B3-45	40	441.7
50	809.04	831.8	P32B1-50	40	115.2	P32B2-50	40	331.4	P32B3-50	40	549.5
57	922.16	945.0	P32B1-57	40	150.2	P32B2-57	40	434.1	P32B3-57	40	720.4
60	970.65	993.4	P32B1-60	40	166.5	P32B2-60	40	482.2	P32B3-60	40	800.5
76	1229.28	1252.0	P32B1-76	40	268.1	P32B2-76	40	782.0	P32B3-76	40	1300.0

All dimensions in mm.
Stock Platewheels can be reworked to customers bore and keyway requirements, on 48 hour service.
Platewheels manufactured in steel 8 to 21 tooth with a minimum U.T.S. 600N/mm² - Above 21T - 410N/mm²
Platewheels 8 to 21 tooth can be supplied with teeth induction hardened to 45Rc.

Email sales@crossmorse.com
 Fax +44(0) 121 325 1079
 Fax +44(0) 121 360 0155
 Tel +44(0) 121 360 0155

Steel Adaptors for Platewheels



Tel +44(0) 121 360 0155

Fax +44(0) 121 325 1079

Email sales@crossmorse.com

Steel adaptors, used in conjunction with standard platewheels (pp 59-68) enable low cost production of steel sprockets with tooth range 19-114 teeth. Three types of adaptors are available, threaded adaptor, weld-on hubs, and detachable hubs.

The threaded adaptors were originally developed to convert cycle sprockets for industrial use. They enable simple, quick exchange of platewheels to adjust drives for prototypes and development work. These adaptors are suitable for simplex platewheels from $\frac{3}{8}$ " to $\frac{3}{4}$ " pitch chain, and also for Industrial Ratchet Freewheels (refer catalogue 'Freewheel Clutches').

The weld-on hubs are designed to enable conversion of platewheels to sprockets, with a fully welded construction. They are available with pilot parallel bore, finish bored and keyed, or bored to suit standard taper bushes.

Detachable hubs enable modifications in the field by replacement of platewheels. A limited level of phasing can also be achieved, dependant on number of teeth in the sprocket. In addition to production of sprockets, adaptors can also be used in the construction of fans, wheels and conveyor rollers.



Threaded Adaptors with Solid Bore

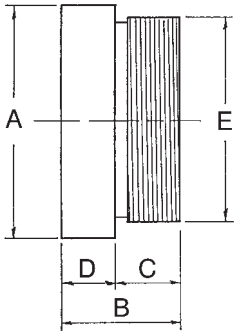

Hub Ref.	Max Bore	A Max	B	C	D	E R.H. Thread C.E.I. Form 24T.P.I.	Approx. Weight Kg
A211	20	42	27	14.3	12.7	1.37"	0.23
A212	24	48	27	14.3	123.7	1.625"	0.32
A213	30	58	27	14.3	12.7	2.00"	0.48

Hubs can be supplied bored, keywayed and setscrewed to customers requirements. Some sizes platewheels for 081, and 08B-1 chain stocked with threaded bore for A211 adaptor.

Steel Weld-on Hubs with Pilot Bore

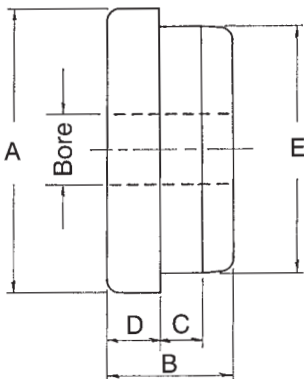

Hub Ref.	Pilot Bore Size	Max Bore	A	B	C	D	E	Approx. Weight Kg
A214	20	40	70	38	11	16	60.00 59.95	0.89
A215	20	45	80	38	11	16	70.00 59.95	1.25
A216	25	55	95	44	13	19	85.00 84.95	2.10
A217	25	70	120	44	13	19	110.00 109.95	3.51
A218	25	85	145	51	16	19	130.00 129.95	5.78

Hubs can be supplied bored and keywayed to customers requirements.

Steel Weld-on Hubs with Taper Bore

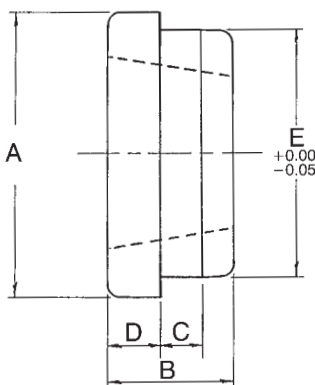

Hub Ref.	Use Bush Size	Max Bore	A	B	C	D	E	Approx. Weight Kg
H12	1210	32	70	25	10	9	65	0.25
H16	1610	42	80	25	10	9	75	0.41
H20	2012	50	95	32	12	12	90	0.75
H25	2517	60	115	45	15	19	110	1.48
H30	3020	75	145	51	15	19	140	2.73
W30	3030	75	145	76	15	19	140	4.05
H35	3525	90	190	65	25	25	180	4.70
W35	3535	90	190	89	25	25	180	6.40
H40	4040	100	200	102	30	32	190	13.80

Hubs are taper bored and drilled to suit standard taper bushes (refer pp. 38/39). Earlier series 'M' taper bore hubs are available on short delivery. M25 & M30 have been superseded by H25 & H30 respectively. All dimensions in mm.

Steel Adaptors and Idler Sprockets



Detachable Hubs

Hub Ref.	Min. Bore	Max. Bore	A	B	C	D	E	F	H	App. Wt.
D30	8	20	55	45	30	20.0	4.2	4	3.0	0.15
D40	10	26	70	58	40	25.0	5.2	5	5.2	0.32
D50	14	32	80	67	50	32.0	6.2	7	7.0	0.61
D60	16	40	90	76	60	38.5	6.2	7	8.7	0.95
D70	20	45	110	94	70	45.5	8.2	8	10.5	1.90
D80	25	52	130	107	80	55.0	8.2	12	15.0	2.65
D100	30	65	170	140	100	73.0	10.2	17	23.0	6.00
D140	35	90	220	182	140	83.0	12.2	20	23.0	13.08
D160	40	104	245	205	160	93.0	16.5	25	25.0	18.80

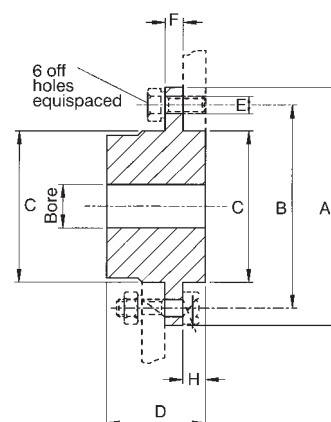

All dimensions in mm.
Hubs can be supplied bored and keywayed to customers requirements.

Idler Sprockets

The standard Idler Sprockets in this series are supplied complete with built in fully shielded and greased for life ball bearing, providing full lifetime maintenance free operation. Two standards of bearings are offered, an economy bearing for light duty applications, and a top quality European bearing for higher loads and speeds.

The extended width inner race enables correct mounting on the shaft without the need for spacers. The sprocket is manufactured from medium carbon steel and secured to the outer race of the bearing by press fit. Many chain drives, by virtue of their design, require a tensioning sprocket, and where fixed idlers are preferred this range of Idler Sprockets provides the ideal solution.

In addition to the standard range, Idler Sprockets can be manufactured to order to suit other sizes of B.S. Standard Chains and ANSI Series, in both Simplex and Multistrand construction, and with alternate numbers of teeth.

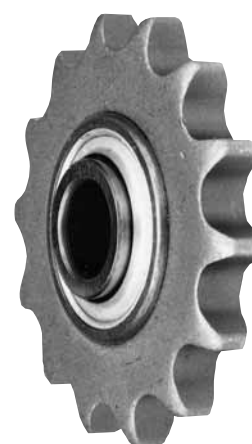

Part No.	Chain Size	Sprocket Dimensions				Bearing Dimensions				Weight
		No. Teeth	P.C.D.	OD	Tooth Width	Min Bore	Hub Dia	LTB	Approx. kg	
		Z	dp	do	A	d	F	B	H	
IS05B1-23T	05B1	23	58.75	62.0	7.0	16.0	40.0	12.0	18.3	0.15
IS06B1-20T	06B1	20	60.89	64.3	7.0	16.0	40.0	12.0	18.3	0.07
IS06B1-21T	06B1	21	63.90	68.0	7.0	16.0	40.0	12.0	18.3	0.16
IS081-18T	081	18	73.14	78.9	7.0	16.0	40.0	12.0	18.3	0.21
IS083-16T	083	16	65.10	70.9	7.0	16.0	40.0	12.0	18.3	0.50
IS083-18T	083	18	73.14	78.9	7.0	16.0	40.0	12.0	18.3	0.20
IS08B1-14T	08B1	14	57.07	61.8	7.2	16.0	40.0	12.0	18.3	0.11
IS08B1-15T	08B1	15	61.09	65.5	7.2	16.0	40.0	12.0	18.3	0.12
IS08B1-16T	08B1	16	65.10	69.5	7.2	16.0	40.0	12.0	18.3	0.18
IS08B1-18T	08B1	18	73.14	77.8	7.2	16.0	40.0	12.0	18.3	0.23
IS08B1-20T	08B1	20	81.19	85.8	7.2	16.0	40.0	12.0	18.3	0.26
IS08B1-21T	08B1	21	85.22	89.7	7.2	16.0	40.0	12.0	18.3	0.26
IS10B1-13T	10B1*	13	66.32	73.0	9.1	16.0	40.0	12.0	18.3	0.24
IS10B1-14T	10B1*	14	71.34	78.0	9.1	16.0	40.0	12.0	18.3	0.24
IS10B1-15T	10B1*	15	76.36	83.0	9.1	16.0	40.0	12.0	18.3	0.27
IS10B1-16T	10B1*	16	81.37	88.0	9.1	16.0	40.0	12.0	18.3	0.32
IS10B1-17T	10B1*	17	86.39	93.0	9.1	16.0	40.0	12.0	18.3	0.33
IS10B1-18T	10B1*	18	91.42	98.3	9.1	16.0	40.0	12.0	18.3	0.30
IS10B1-21T	10B1*	21	106.52	113.4	9.1	16.0	40.0	12.0	18.3	0.50
IS12B1-12T	12B1	12	73.60	81.5	11.1	16.0	40.0	12.0	18.3	0.32
IS12B1-13T	12B1	13	79.59	87.5	11.1	16.0	40.0	12.0	18.3	0.36
IS12B1-15T	12B1	15	91.63	99.8	11.1	16.0	40.0	12.0	18.3	0.45
IS12B1-16T	12B1	16	97.65	105.5	11.1	16.0	40.0	12.0	18.3	0.50
IS16B1-12T	16B1	12	98.14	109.0	16.2	20.0	47.0	14.0	17.7	0.65
IS16B1-15T	16B1	15	122.17	133.0	16.2	20.0	47.0	14.0	17.7	1.10
IS16B1-17T	16B1	17	138.24	149.0	16.2	20.0	47.0	14.0	17.7	1.50
IS20B1-13T	20B1	13	132.65	147.8	18.5	25.0	52.0	15.0	21.0	1.50

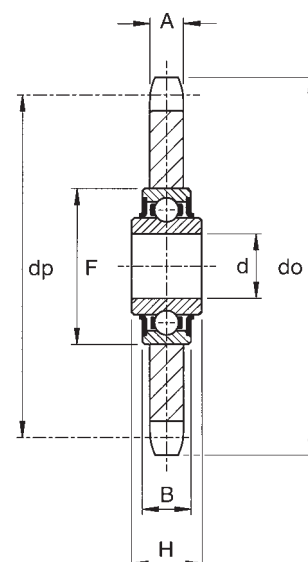

*Also suitable for ANSI 50 Chain.

Cross Tensioners provide constant belt or chain tension. Their automatic tensioning action translates into improved performance and extended life for most types of fixed-centre drives. Additionally, the built-in spring mechanism acts as a buffer, absorbing momentary overloads and reducing vibration. Tensioners are available in a number of sizes and mounting styles, ideally suited for drives on agricultural machinery, off-road vehicles, conveyors, packaging machinery, printing presses and many other industrial applications. Precision construction and high-quality materials are combined for a superior product with proven durability in the toughest environments. Tensioners can be supplied as base units for adaption by customer, or as complete assemblies with chain sprockets/guides for roller chain applications. There are two basic designs of tensioners available; the Rotary Tensioner and the Linear Tensioner.

Rotary Tensioner Type RT

Rotary Tensioners provide a full 90° of useable tensioning action. This unique design conserves space and simplifies tensioning adjustment. The fully automatic takeup action is achieved by using multiple alloy steel compression springs completely captivated within the body of the tensioner. There are no exposed moving parts that can cause injury or jam under adverse conditions. Both body members are high quality aluminium diecastings fitted with oil-impregnated sintered bronze bearings. They are ideally suited for use on outdoor equipment, operating reliably at both high and low temperatures. For extremely corrosive applications, units with stainless steel springs can also be supplied. Levels of tension can be set with aid of the adjustment marks on the rim of the rotating arm. For additional positional security a 6mm diameter locking pin hole is provided on the rear mounting face. The basic tensioner is combined with roller chain idler sprockets for a standard range of chain tensioners, see series CRT.

Linear Tensioner Type LT

Linear Tensioners provide fully automatic straight-line takeup for all types of drive mechanisms. Each unit consists of a rectangular aluminium diecasting which houses two hardened and ground steel reciprocating shafts which are outwardly spring-loaded. The shafts are attached to a triangular mounting block. All components are made of metal; there are no rubber elements to stretch or cold flow when exposed to harsh operating conditions. Use of sintered bronze oil-impregnated bearings assures long trouble-free life with no need for maintenance. For extremely corrosive applications, units fitted with stainless steel shafts and springs are available. To provide a standard series of chain tensioners, series CLT the triangular mounting block is replaced by polyethylene chain guides. Two series are available, the standard with 89mm radii guides for smooth operation, and a compact series with reduced radii guides for when space is limited. For applications where rigid adjustment is preferred tensioners type CT can be used.

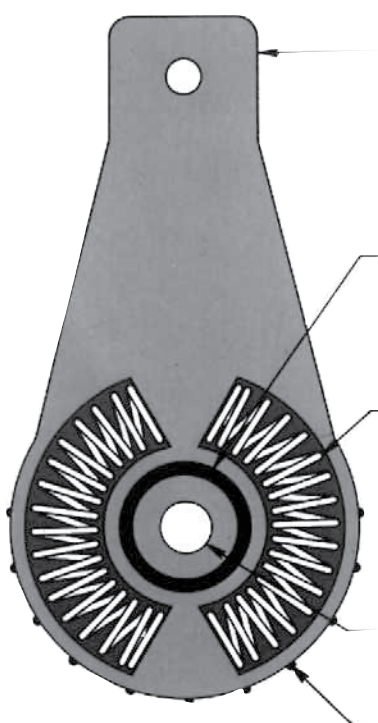

Frames

All structural members are made of high-strength diecast aluminium material. Heavy wall sections and/or ribbing prevents deflection under eccentric loads. All mounting surfaces and bearing seats are fully machined.

Bearings

Oil-impregnated, sintered bronze bearings are used to provide smooth, reliable movement at all wear points. Bearings are press-fitted in position and never require lubrication.

Springs

Tensioning action is provided by the use of multiple compression springs. These springs are made from alloy steel accurately wound to tight manufacturing tolerances to provide consistent tensioning force. Springs are grease-lubricated for long life and quiet operation.

Mounting Holes

Only a single bolt is required for mounting and tension adjustment.

Adjustment Marks

Enable easy setting of tension.

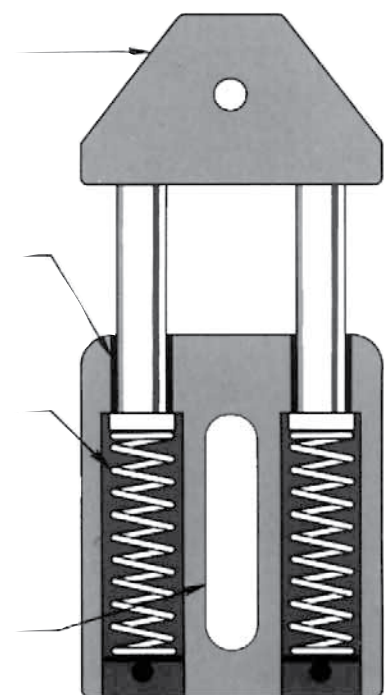

Cross Tensioners



Email sales@crossmorse.com

Rotary Tensioner - Series RT

Provides up to 90° useable tensioning action.

A blind hole is provided in the mounting face to enable location with a pin in the framework if rapid positioning of the tensioner is required.

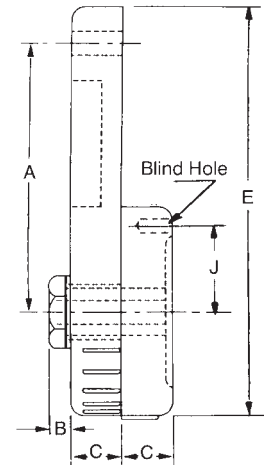
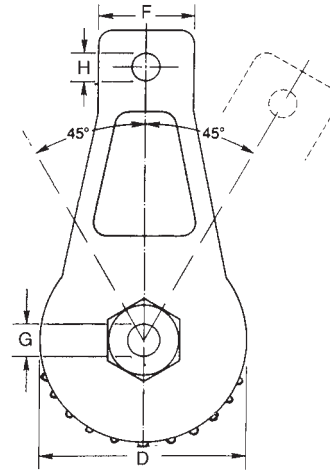
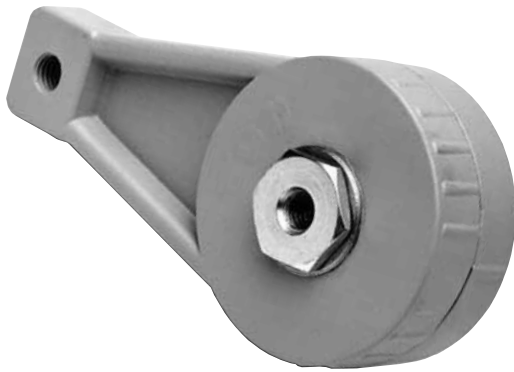

Blind Hole 9mm deep
6mm Ø RT 1000 Series
8mm Ø RT 2000 Series

Cat. No.	Torque Range	A	B	C	D	E	F	G	H	J
RT1001	8-18 Nm	88.9	5.6	15.0	70	136	30	3/8" UNC	M10	29.5
RT1002	8-18 Nm	88.9	5.6	15.0	70	136	30	3/8" UNC	10	29.5
RT2001	20-34 Nm	101.6	6.9	17.5	92	160	37	1/2" UNC	1/2" UNC	36.0
RT2002	20-34 Nm	101.6	6.9	17.5	92	160	37	1/2" UNC	13	36.0

RT Series incorporate adjustment marks every 15 degrees to enable simple setting.

Linear Tensioner - Series LT

Provides up to 43mm linear adjustment with accurate control.

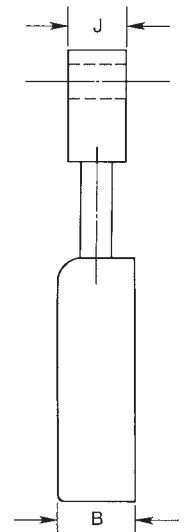
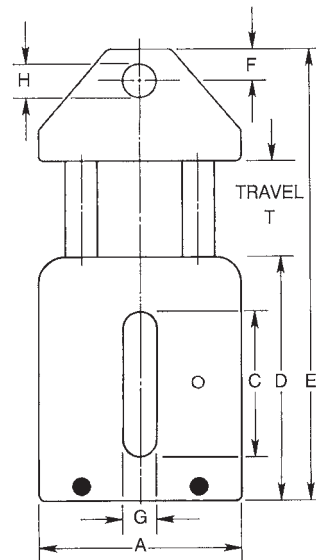

Cat. No.	Spring Force N	Travel T	A	B	C	D	E min	E max	F	G	H	J	T
LT1002	66-178	29	60	25	48	75	111	140	10	10.5	9.9	20	29
LT2002	89-267	31	75	30	60	90	144	175	12	12.5	13.0	25	31
LT3002	155-400	43	90	35	75	108	167	210	14	14.5	13.0	30	43

All dimensions are in mm except where indicated.

LT Series can be supplied with hole 'H' tapped to 3/8" UNC (LT 1000 Series) or 1/2" UNC (LT 2000 and 3000 Series).

Fax +44(0) 121 325 1079

Tel +44(0) 121 360 0155

Rotary Chain Tensioners



Suitable for Simplex, Duplex and Triplex Chain Drives for British Standard Roller Chains

Sprung loaded chain tensioners can extend the life of roller chain on fixed centre drives by more than 30%, particularly where centre distance exceeds 40 times chain pitch. They can be used for drives operating in either direction providing a smoother drive, self tensioned and so are virtually maintenance-free. Of robust construction the chain tensioners provide an angular movement of 45°. A blind location hole is machined on the mounting face at radius J, diametrically opposite the adjustment indicator. Although not required for normal operation of the tensioner, the location hole can be used, with a corresponding pin in the framework, for quick positioning or additional torque resistance.

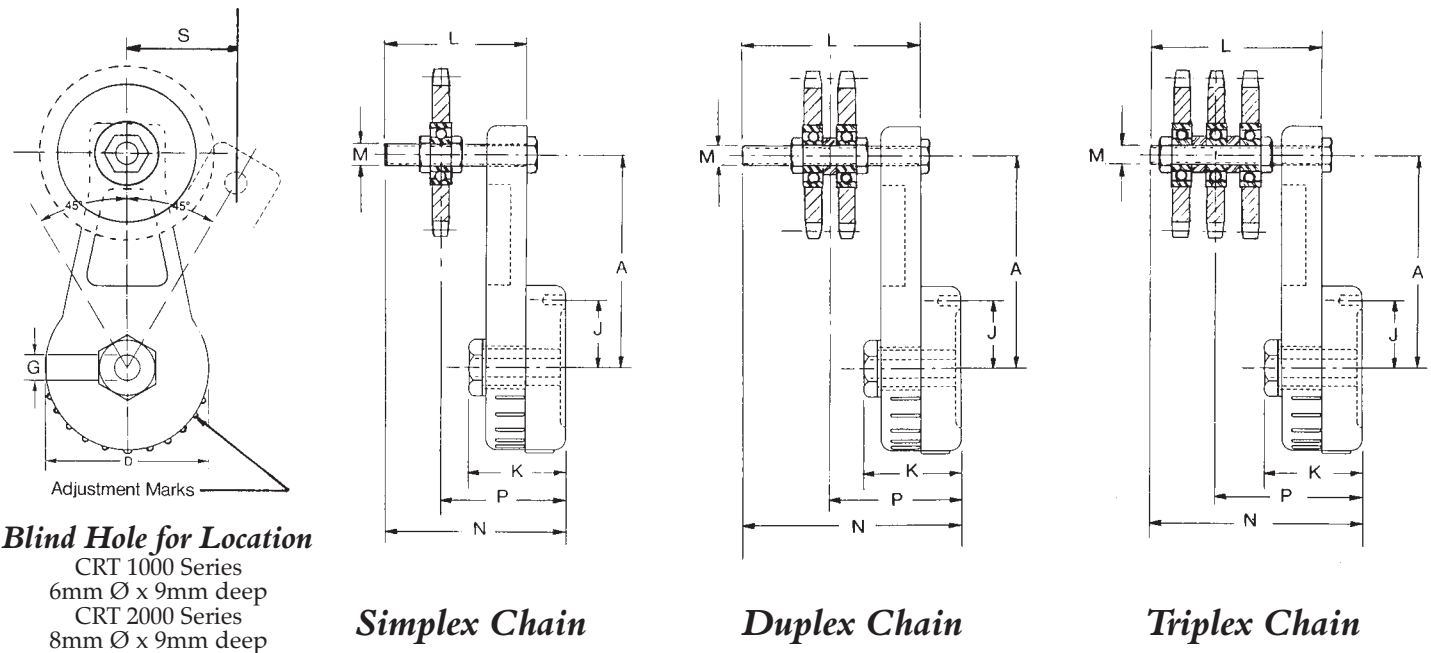

Blind Hole for Location
 CRT 1000 Series
 6mm Ø x 9mm deep
 CRT 2000 Series
 8mm Ø x 9mm deep

Simplex Chain

Duplex Chain

Triplex Chain

Tensioner Cat. No.	Torque Range Nm	Chain Size	No. Teeth Idler Z	A	D	G	J	K	L	M	N	P	S
SIMPLEX CHAIN													
CRT1106	8-18	06B-1	15	88.9	70	3/8" UNC	29.5	35.5	60	M10	75	40-63	63
CRT1108	8-18	08B-1	15	88.9	70	3/8" UNC	29.5	35.5	60	M10	75	42-63	63
CRT1110	8-18	10B-1	15	88.9	70	3/8" UNC	29.5	35.5	80	M10	95	43-83	63
CRT2112	20-34	12B-1	15	101.6	92	1/2" UNC	36.0	42.0	76	1/2" UNC	94	50-80	72
CRT2116	20-34	16B-1	13	101.6	92	1/2" UNC	36.0	42.0	102	1/2" UNC	120	58-100	72
CRT2120	20-34	20B-1	13	101.6	92	1/2" UNC	36.0	42.0	102	1/2" UNC	120	61-100	72
DUPLEX CHAIN													
CRT1206	8-18	06B-2	15	88.9	70	3/8" UNC	29.5	35.5	60	M10	75	45-58	63
CRT1208	8-18	08B-2	15	88.9	70	3/8" UNC	29.5	35.5	60	M10	75	49-56	63
CRT1210	8-18	10B-2	15	88.9	70	3/8" UNC	29.5	35.5	80	M10	95	50-75	63
CRT2212	20-34	12B-2	15	101.6	92	1/2" UNC	36.0	42.0	76	1/2" UNC	94	60-70	72
CRT2216	20-34	16B-2	13	101.6	92	1/2" UNC	36.0	42.0	102	1/2" UNC	120	75-86	72
TRIPLEX CHAIN													
CRT1306	8-18	06B-3	15	88.9	70	3/8" UNC	29.5	35.5	60	M10	75	50-53	63
CRT1308	8-18	08B-3	15	88.9	70	3/8" UNC	29.5	35.5	80	M10	95	56-59	63
CRT1310	8-18	10B-3	15	88.9	70	3/8" UNC	29.5	35.5	80	M10	95	59-66	63
CRT2312	20-34	12B-3	15	101.6	92	1/2" UNC	36.0	42.0	102	1/2" UNC	120	70-85	72

All dimensions in mm except where indicated.

Mounting Instructions

The tensioner should always be mounted on the non-driving strand of chain, near to the larger sprocket and in mesh with the outside of the chain. The tensioner arm should be located so that its operating direction is opposite to that of the fixing screw. A clearance hole for the fixing screw is required in the machine framework. The mating surface on which the boss is mounted should be smooth, level and parallel to the line of drive.

The tension pressure is set by slightly loosening the fixing screw, then rotating the hexagon nut and housing to apply suitable tension to the chain, and locking in position by tightening the fixing screw. Tension pressures can be infinitely varied over the torque range indicated in the table. The adjustment marks on the torque arm body can be used for quick setting.

Tel +44(0) 121 360 0155 Fax +44(0) 121 325 1079 Email sales@crossmorse.com

Linear Chain Tensioners



Email sales@crossmorse.com
 Fax +44(0) 121 325 1079
 Fax +44(0) 121 360 0155
 Tel +44(0) 121 360 0155

The Linear Chain Tensioners are based on the 'LT' Series Tensioner, with the aluminium mounting block replaced by a plastic chain guide.

Mounted on the unloaded strand of the chain in compressed condition, the tensioner takes out slack in the chain drive. As the chain wears, the tensioner extends under its spring to take-up the slackness in the drive. The chain guides are manufactured from UHMW Polyethylene, selected for its inherent self lubricating properties, and are available in two series.

The standard series utilises a large radius guide in arc form to provide a smooth chain transmission for quiet operation with minimised wear.

The compact series have smaller radii circular guides, with full 180° wrap possible. These are used where space is restricted, and for tail sprockets on light loaded conveyors. Tensioners are available for simplex, duplex and triplex drives, and are also suitable for extended pitch and rollerless (bush) chains.

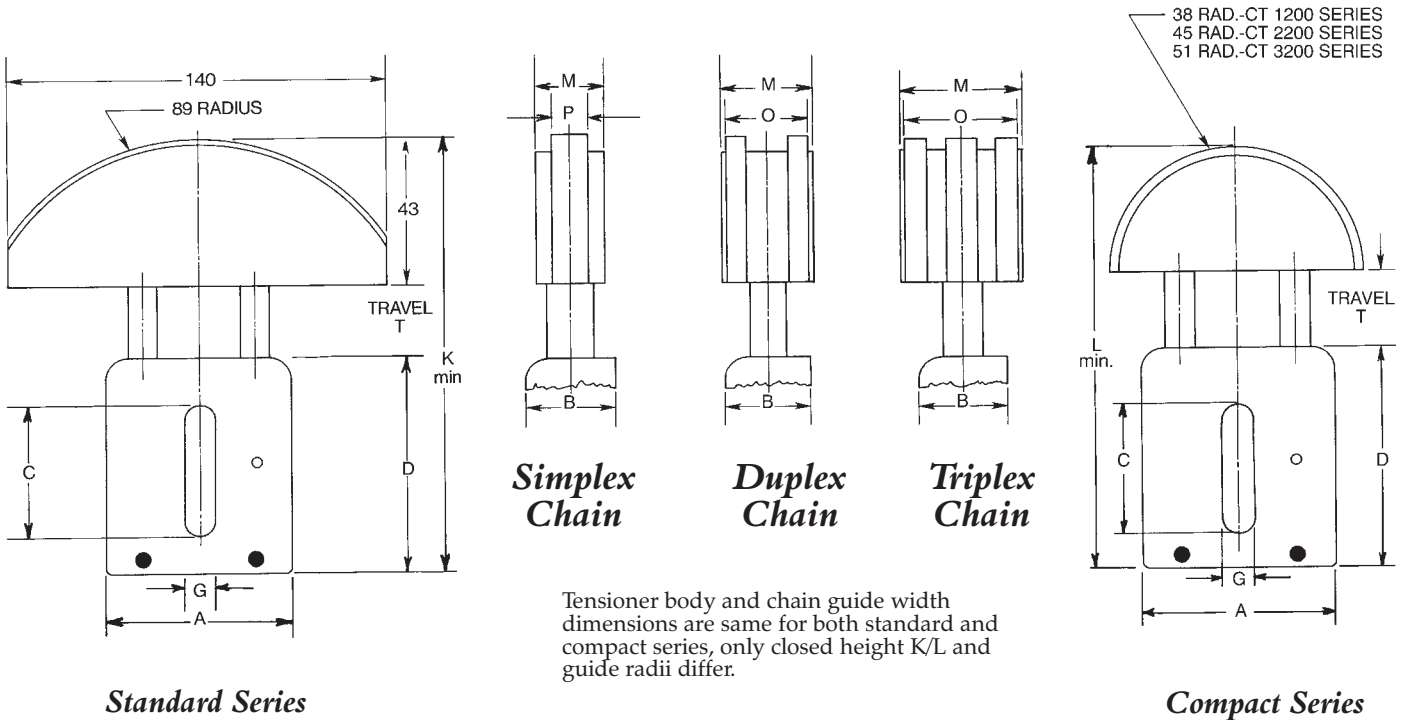

Chain Size	Catalogue No.		Spring Force N	Dimensions - mm										
	Std. Series	Compact Series		A	B	C	D	G	K* min.	L* min.	M	O	P	T
SIMPLEX CHAINS														
06B-1	CLT 1101	CLT 1201	66-178	60	25	48	75	10.5	119	114	20	-	5.1	29
08B-1	CLT 1102	CLT 1202	66-178	60	25	48	75	10.5	119	114	20	-	7.1	29
10B-1	CLT 2101	CLT 2201	89-267	75	30	60	90	12.5	134	135	22	-	8.9	31
12B-1	CLT 2102	CLT 2202	89-267	75	30	60	90	12.5	134	135	22	-	10.7	31
16B-1	CLT 3101	CLT 3201	155-400	90	35	75	108	14.5	152	160	25	-	15.7	43
20B-1	CLT 3102	CLT 3202	155-400	90	35	75	108	14.5	152	160	25	-	18.0	43
DUPLEX CHAINS														
06B-2	CLT 1103	CLT 1203	66-178	60	25	48	75	10.5	119	114	20	15.3	-	29
08B-2	CLT 1104	CLT 1204	66-178	60	25	48	75	10.5	119	114	22	20.9	-	29
10B-2	CLT 2103	CLT 2203	89-267	75	30	60	90	12.5	134	135	25	25.0	-	31
12B-2	CLT 2104	CLT 2204	89-267	75	30	60	90	12.5	134	135	35	30.0	-	31
16B-2	CLT 3103	CLT 3203	155-400	90	35	75	108	14.5	152	160	45	44.5	-	43
TRIPLEX CHAINS														
06B-3	CLT 1105	CLT 1205	66-178	60	25	48	75	10.5	119	114	25	25.0	-	29
08B-3	CLT 1106	CLT 1206	66-178	60	25	48	75	10.5	119	114	35	34.8	-	29
10B-3	CLT 2105	CLT 2205	89-267	75	30	60	90	12.5	134	135	45	39.4	-	31

*Lmax = Lmin+T
Kmax = Kmin+T

Mounting Instructions

The tensioner should be positioned to operate on the outer side of the non-driving strand of chain. The surface to which the tensioner is clamped must be flat, smooth, and parallel to the line of drive. The tensioner is retained by a metric bolt with standard washer located at a minimum distance from chain centre line equal to (K - 0.7D + 1)mm or (L - 0.7D + 1)mm as applicable. On initial installation the bolt will be at the top of the slot providing automatic chain adjustment over travel distance T. If further movement is later required the unit can be advanced and reclamped with bolt lower in the slot.

Efson Fixed Chain Tensioners



The Efson Fixed Chain Tensioner uses the UHMW polyethylene circular guides from the compact linear tensioner, mounted in a rugged die cast aluminium frame which is slotted to enable quick adjustment in any direction using a single bolt.

This economical tensioner is ideal for applications where automatic tensioning is not required and for drives subject to frequent speed changes or torque reversals. It is possible to reverse drives with this tensioner providing speeds and chain loads are low.

The tensioner should always be mounted on the outside of the non driving chain strand close to the larger sprocket.

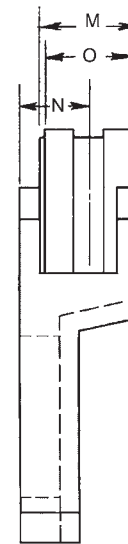
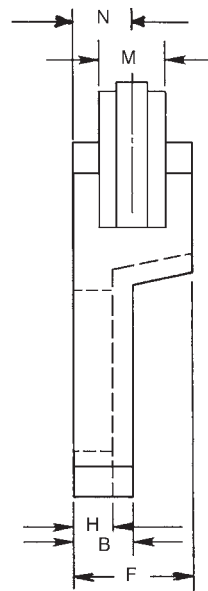
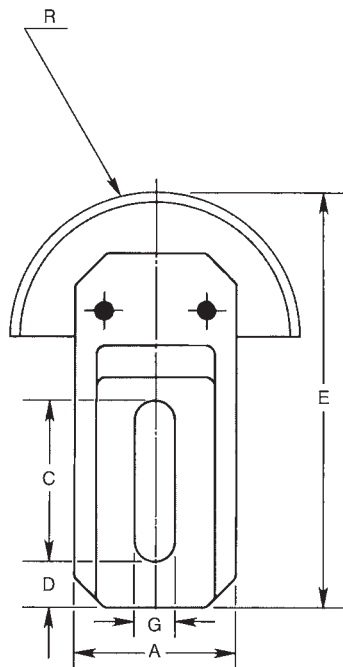

Simplex Chain

Duplex Chain

Catalogue No.	Chain Size	Dimensions in mm											
		A	B	C	D	E	F	G	H	M	N	O	R
CT1401	06B-1	40	15	73	10	141	30	10.5	10	20	15		38
CT1402	06B-2	40	15	73	10	141	30	10.5	10	20	15	15.3	38
CT1403	08B-1	40	15	73	10	141	30	10.5	10	20	15		38
CT2401	08B-2	50	18	85	12	157	36	13	12	22	18	20.9	38
CT2402	10B-1	50	18	85	12	164	36	13	12	22	18		45
CT2403	12B-1	50	18	85	12	164	36	13	12	22	18		45
CT3401	10B-2	60	20	82	13	164	40	13	14	25	20	25.0	45
CT3402	12B-2	60	20	82	13	164	40	13	14	35	25	30.0	45
CT3403	16B-1	60	20	82	13	169	40	13	14	25	20		51
CT3404*	16B-2	60	20	82	13	169	40	13	14	45	30	44.5	51
CT3405*	20B-1	60	20	82	13	169	40	13	14	25	20		51

*On these tensioner sizes additional clearance is required beyond tensioner mounting block to provide minimum chain path clearance.

Mounting Instructions

The tensioner should be positioned to operate on the outer side of the normally non-driving strand of chain. The surface to which the tensioner is clamped must be flat, smooth and parallel to the line of drive. The tensioner is retained by a single bolt with standard washer located at a minimum distance from chain centre line of 1/2E. Adjustment is made by positioning of bolt in slot plus turning tensioner up to 45 degrees from the perpendicular to chain centre line.

Tel +44(0) 121 360 0155

Fax +44(0) 121 325 1079

Email sales@crossmorse.com

'HV' Inverted Tooth Chain Drives



Email sales@crossmorse.com
Fax +44(0) 121 325 1079
Tel +44(0) 121 360 0155

For High Velocity, High Horsepower and High Efficiency Drives with smooth transmission of load in a compact space.

Morse HV Drives provide the Drive Designer with a new concept in the transmission of power for high speed, high load applications. Proven in a wide range of applications from high production automobiles to custom-designed flood control pumps, HV Drives offer opportunity for flexibility, compactness, weight saving and economy. In the late 1940's Morse Chain Engineers developed the original design of 'HV' to meet the high speed, high load requirements of Oil Well Drilling equipment. The first chain 2" Pitch x 12" Wide transmitted 1300kW at 650 r.p.m. on the slush pump of a drill rig. Success on this and similar applications led to the further development of a family of chains from $\frac{3}{8}$ " to 2" pitch which have been successfully applied to a wider variety of industrial applications including Roll Grinders, Dynamometers, Pump Drives, Gas Turbine Starters, four Square Test Rig, and many Automotive Transmissions. Further development of HV chain enables drives over 2,500kW being accommodated with standard chain widths.

'HV' Chain Design

The Chain assembly consists of inverted tooth link plates, laced alternately and connected by two steel pins of the same cross sectional geometry, which form an articulating joint between the link sections.

'HV' Link Plate Design

The link design in the original HV pitches - $\frac{3}{4}$ ", 1", 1 $\frac{1}{2}$ " and 2" (Fig 1) had been tested and proven for many years. The link crotch is located slightly above the line of pull and all corners are rounded to minimise the possibility of stress risers and to ensure maximum performance on high load industrial applications. The $\frac{3}{8}$ " and $\frac{1}{2}$ " pitch chains (Fig. 2) have a new link contour for increased speed requirements, with the link crotch below the line of pull, and this design is now extended to include $\frac{3}{4}$ " and 1" pitches. Photo-elastic studies of various link shapes and aperture positions produced the design with the lowest level of stress concentration. Improved metallurgy, and development in design and pressure angle, achieve maximum load capacity with high speed performance. Carefully controlled shot-peening of the links gives them a uniform, matt grey finish and results in an improved level of link fatigue resistance.

Concentric Pin and Rocker Joint

The joint consists of a pin and rocker of identical cross section and contact radii. When chain engages the sprocket teeth the curved surfaces roll on each other eliminating sliding friction, and joint galling. The radii of the pins is selected to give almost perfect pitch compensation to minimise chordal* action. Before engagement with the sprocket the contact point of pin and rocker is below pitch line (Fig. 3). When chain engages with the sprocket teeth, the contact point moves upwards (Fig. 4) with slight elongation of the pitch to wrap the sprocket along the pitch line.

Chordal Action

The compatible design of HV links, joints and sprockets reduces the detrimental effects of chordal action to a minimum. The chordal action of conventional chain drives is the vibratory motion caused by the rise and fall of the chain as it engages sprocket teeth. This motion causes vibration and limits high speed load carrying capability. Of all types of chains, HV operates most efficiently at all speeds because chordal action is reduced to a minimum. Fig 5. shows how HV chain enters approximately tangent to the pitch circle of the sprocket and maintains this position as it travels around the sprocket. This smooth engagement permits high speed capabilities with efficiency and quietness.

Involute Tooth Sprocket

The third criteria for the success of HV is the mating sprockets. An involute tooth form, differing from the straight sided teeth of conventional silent chain sprockets is designed for smooth engagement of the chain with the sprocket teeth. All HV sprockets are top-hobbed and the teeth heat treated for tough wear resistant surface. Unlike the single tooth engagement of spur gears, many teeth share the load on a HV drive, resulting in low stresses, less wear, and long sprocket life.

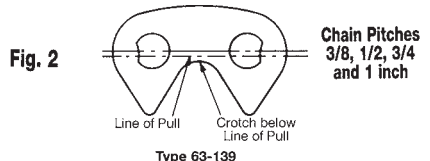
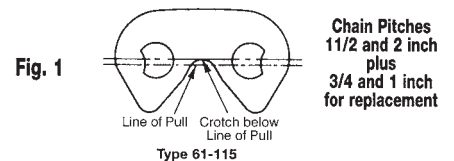

HV Chain Link Plates

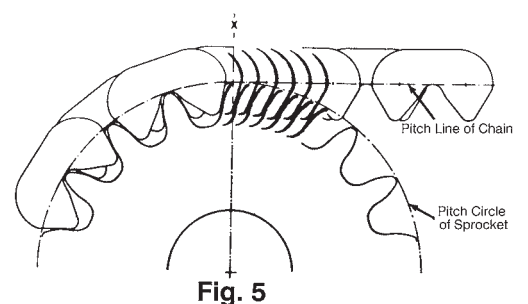
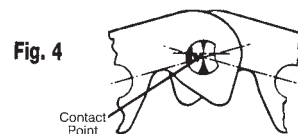
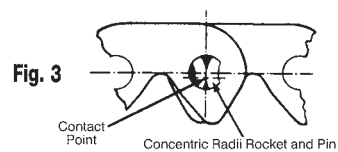

You get more with 'HV'

The features of 'HV' link design, compensating pin and rocker joint, with the involute hobbled sprockets means HV chain can transmit more power, at higher speeds, in less space than other transmission media, with smooth action and minimum of noise.

High Speed Performance Operating chain speeds range from 10 to 35 metres per sec. with higher speeds (to 55m/sec) on special applications.

High Power in Narrow Widths HV chain transmits more power per inch of width than any other chain or belt drive, with capacities up to 6000 kW.

Smooth Quiet Operation The rolling action of the chain joints combined with smooth sprocket engagement minimise induced vibrations. This enables HV chain to provide quiet drives on high speed applications.

High Efficiency Smooth operation, with minimal frictional losses, provide transmission efficiencies up to 99.7%.

'HV' Chain - Selection



Tel +44(0) 121 360 0155 Fax +44(0) 121 325 1079 Email sales@crossmorse.com

There are Seven good reasons to use HV in your design!

HV transfer cases provide weight and cost savings because:

1. **Fewer Shaft** and Bearings are required.
2. **Lighter Loads** on Shaft Bearings.
3. **Chain Bearing Loads** are compressive, placing case in compression, unlike gear forces which are tensile.
4. **HV Cases are Lighter** as compressive loads mean thinner sections can be used.
5. **Centre Distance is less Critical** and more flexible than required by gear and belt drives.
6. **Elasticity of HV Chain** accommodates normal thermal expansion, and helps 'cushion' the drive.
7. **Simplified Design** results in a positive cost saving.

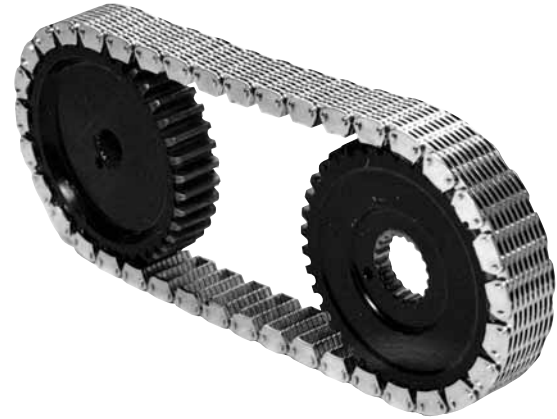

'HV' Drive Selection

Design of a 'HV' Chain Drive involves correct selection of chain and sprockets combined with correct casing design and lubrication system. The Power Rating tables opposite, giving power ratings per inch width of chain, enable selection of chain with drives operating under ideal conditions of smooth power source and load. To use these tables for other drives involving shock loads the Actual Power must be modified by a Service Factor to obtain the Design Power which can then be related to the tables.

Service Factors - S.F.

Type of Load	Int. Comb. Eng. Hydraulic Drive	Electric Motor	Int. Comb. Eng. Mechanical Drive
Smooth	1.0	1.0	1.2
Moderate Shock	1.2	1.3	1.4
Heavy Shock	1.4	1.5	1.7

'HV' Drive Selection

1. Determine the R.P.M. and diameter of the high speed shaft.
2. Determine the total power to be transmitted.
3. From application detail determine proper service factor from table. Refer page 7 in Roller Chain Selection for machine types.
4. Establish Design Power by multiplying total Power to be transmitted by the service factor.

$$\text{Design Power kW} = \text{Motor Power} \times \text{S.F.}$$
5. Select the chain pitch and width and number of teeth in the small sprocket from the Power Rating Tables.
 - a. For quiet and smooth drives use sprockets 25 teeth or more.
 - b. Be sure the small sprocket will accommodate the high speed shaft diameter. As a guide with steel sprockets Pitch Circle Diameter should be minimum twice shaft diameter $\text{PCD} \geq \frac{Z_p}{\pi}$
 - c. If the high speed shaft diameter exceeds the maximum bore in the selected small sprocket it will be necessary either to increase the number of teeth in the sprocket or select the next larger pitch chain.
6. Determine the required drive ratio:

$$\frac{\text{RPM high speed shaft}}{\text{RPM slow speed shaft}} = \text{Ratio}$$
7. Multiply the number of teeth in the small sprocket by the ratio to obtain the number of teeth in the large sprocket.
8. To determine chain length and centre distance refer to page 9. Centre distance and sprocket combination must always provide an even number of pitches of chain. For fixed centre drives it is recommended to use Centre Distance tables. HV drives should always be installed with a slight preload, and to provide this the actual centre distance is obtained by increasing the theoretical by 0.07%. Manufacturing tolerances should always be on the plus side. Further advice on centre distance requirements can be obtained from Cross+Morse Engineering.
9. As more than one pitch of chain could be selected for most applications consideration should be given that the shaft centre distance should never exceed 60 times pitch, and that large pitch, narrow width selections are better for shock loading and commercial considerations; however, small pitch chains operating on sprockets with high numbers of teeth give smoothest drives with minimum noise level. Whilst preliminary drive selection can be made from the tables it is recommended that all 'HV' Drives be referred to Cross+Morse Engineering Department for final approval.
10. The design and manufacture of the sprockets is critical for correct drive operation. General dimensional details are provided on page 81. Sprockets with 35 teeth or less are best manufactured from low carbon alloy steels with teeth carburised and hardened. Larger sprockets can be manufactured from medium carbon steels or mechanite castings and induction or flame hardened. Teeth must be generated to the special involute form for smooth drive operation.
 For 1:1 drives it is preferable to use even tooth sprockets for smooth drive, but on all reduction drives it is best to use odd number teeth in small sprocket for maximum drive life. Idler sprockets should never be used. Cross+Morse can offer the full range of 'HV' sprockets - manufactured to meet customers requirements. If not specified, through bore length, hub diameter and all manufacturing tolerances will be Morse Standards. Materials and Tooth hardness will always be to Morse Specification.

HV Chain - Selection Tables (kW)



The tables below provide power ratings in kW for chains of 1" width. To obtain capacity of other widths multiply width (inches) by rating obtained from table. Whilst tables cover sprockets from 21 teeth, it is recommended to use a minimum of 25 teeth for maximum chain performance and life. Preliminary selection can be made with these tables, but it is recommended that all selections should be confirmed with Cross & Morse Engineering prior to implementation. For applications with powers and/or speeds outside tables, consult Cross+Morse Engineering.

3/8" Pitch - HV3 Chain Type 63-139

Stock Widths:
3/4", 1", 1 1/2", 2", 3"

No. Teeth	RPM														
	1500	2000	2500	3000	3500	4000	4500	5000	5500	6000	6500	7000	7500	8000	9000
21	19	25	31	37	42	48	53	58	62	66	70	73	76	78	80
23	21	27	34	40	46	52	57	62	66	70	74	77	79	80	81
25	22	29	36	43	50	56	61	66	70	74	77	79	80	81	
27	24	32	39	47	53	59	65	69	74	77	79	80	81		
29	26	34	42	50	56	62	68	72	76	79	80	81			
31	28	36	45	52	59	65	71	75	78	80	81				
35	31	41	50	58	65	71	76	79	80	81					
39	34	45	54	63	70	75	79	80							
45	39	51	61	69	76	80	81								

1/2" Pitch - HV4 Chain Type 63-139

Stock Widths:
1", 1 1/2", 2", 3", 4"

No. Teeth	RPM														
	1000	1250	1500	1750	2000	2500	3000	3500	4000	4500	5000	5500	6000	6500	7000
21	26	32	39	45	51	63	74	85	95	104	112	119	125	129	132
23	28	35	42	49	56	68	80	92	102	111	118	125	129	132	133
25	30	38	46	53	60	74	86	98	109	117	125	129	132	133	
27	33	41	49	57	65	79	92	104	114	122	128	132	133		
29	35	44	53	61	69	84	97	109	119	126	131	133			
31	38	47	56	65	74	89	103	115	124	130	133				
35	43	53	63	72	82	98	112	123	130	133					
39	48	59	70	80	89	106	120	129	133						
45	54	67	79	89	100	117	128	133							

3/4" Pitch - HV6 Chain Type 63-139

Stock Widths:
1 1/2", 2", 3", 4", 5"

No. Teeth	RPM														
	600	900	1200	1500	1800	2100	2400	2700	3000	3300	3600	3900	4200	4500	4800
21	33	48	64	79	94	107	120	132	143	153	161	168	172	176	177
23	36	53	70	86	101	116	129	142	152	161	168	174	177	177	176
25	39	57	75	93	110	125	138	150	160	168	174	177	177	175	170
27	42	62	81	100	117	132	146	157	166	173	176	177	175		
29	45	66	86	106	124	139	153	164	171	177	177	175			
31	48	71	92	113	130	146	160	169	175	177	175				
35	54	79	103	124	143	158	169	176	177	173					
39	60	87	113	136	154	168	176	177	172						
45	69	99	127	150	166	177	175								

1" Pitch - HV8 Chain Type 63-139

Stock Widths:
2", 3", 4", 5", 6"

No. Teeth	RPM														
	600	800	1000	1200	1400	1600	1800	2000	2200	2400	2600	2800	3000	3300	3600
21	54	72	89	105	121	136	150	163	174	185	195	202	208	214	215
23	59	78	96	114	130	146	161	174	186	195	203	210	214	215	212
25	64	84	104	123	140	156	171	184	195	204	210	214	215	212	200
27	69	91	112	131	150	166	180	193	203	210	214	215	213	203	
29	74	97	119	139	159	175	189	200	209	214	215	213	206		
31	79	104	127	148	167	183	197	207	213	215	213	206			
35	89	116	140	163	182	197	208	214	215	210					
39	98	127	154	176	195	207	214	215	208						
45	112	145	171	193	208	215	213	200							

1 1/2" Pitch - HV12 Chain Type 61-115

Stock Widths:
3", 4", 5", 6"

No. Teeth	RPM														
	200	400	600	800	1000	1200	1400	1500	1600	1800	2000	2100	2200	2400	2500
21	29	58	85	111	135	155	172	179	185	193	196	195	195	184	142
23	32	63	93	121	144	165	181	187	191	196	194	190	183	151	
25	35	68	100	129	154	174	188	192	195	194	186	172			
27	37	73	107	138	162	182	193	195	196	189					
29	40	79	115	146	171	188	196	195	193	173					
31	43	84	121	153	177	193	196	192	186						
35	48	94	135	167	188	196	188	172							
39	53	104	147	178	195	192									
45	62	117	163	191	194										

2" Pitch - HV16 Chain Type 61-115

Stock Widths:
3", 4", 5", 6"

No. Teeth	RPM														
	200	300	400	500	600	700	800	900	1000	1100	1200	1300	1500	1700	1800
21	47	70	92	114	134	153	170	186	199	210	219	224	226	215	203
23	51	77	101	124	145	165	181	197	210	219	225	227	219	194	
25	56	83	109	134	155	175	193	207	218	225	227	225	205		
27	60	90	117	143	166	186	202	215	224	227	225	217	182		
29	65	95	124	151	175	195	210	222	227	226	219	204			
31	69	102	132	160	183	203	217	225	227	221	207				
35	78	114	147	175	199	216	225	227	218	198					
39	86	125	160	189	211	224	227	217	195						
45	98	142	179	207	224	227	213	182							

It is essential that drives selected in the area right of the tinted area are fitted with a pressure fed spray lubrication system. Other drives can operate in oil bath lubrication.

Note: Other widths of chain up to 8 times pitch can be supplied to order.

Tel +44(0) 121 360 0155 Fax +44(0) 121 325 1079 Email sales@crossmorse.com

HV Chain Dimensions



Riveted Pin Assembly
(showing both styles)

Connecting Pin Spiral Pin Type
All Pitches

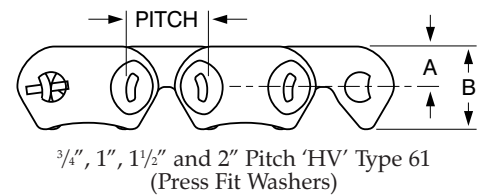
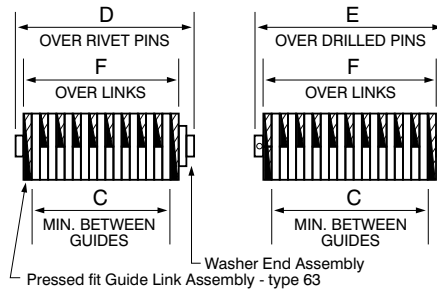
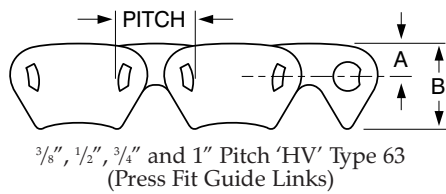

Chain Dimensions - Imperial Widths

'HV' Chain Designation	Nominal Width Inches	Chain Pitch ins (mm)	Chain Height above Spkt. PCD A mm	Chain Height B mm	Min Width between Guides C mm	Width over Links F mm	Width over Rivet Pin D mm	Width over Drilled Pins E mm	Average U.T.S. kN	Ave. Weight per Metre kg
3/8" PITCH 63 type HV										
HV-303	3/4	3/8" (9.525)	4.3	10.9	17.4	20.6	22.7	26.1	25	1.0
HV-304	1									
HV-305	1.1/4									
HV-306	1.1/2									
HV-308	2									
HV-312	3									
1/2" PITCH 63 type HV										
HV-403	3/4	1/2" (12.70)	5.7	14.5	17.4	20.6	22.7	26.1	33	1.3
HV-404	1									
HV-405	1.1/4									
HV-406	1.1/2									
HV-408	2									
HV-410	2.1/2									
HV-412	3									
HV-416	4									
3/4" PITCH 63 type HV										
HV-606/139	1.1/2	3/4" (19.05)	9.8	21.7	36.3	40.5	43.3	47.4	100	4.0
HV-608/139	2									
HV-612/139	3									
HV-616/139	4									
HV-620/139	5									
HV-624/139	6									
1" PITCH 63 type HV										
HV-808/139	2	1" (25.40)	11.4	29.0	48.0	54.2	58.1	64.7	178	7.1
HV-812/139	3									
HV-816/139	4									
HV-820/139	5									
HV-824/139	6									
3/4" PITCH 61 type HV										
HV-606	1.1/2	3/4" (19.05)	10.3	20.9	31.7	35.9	43.2	43.4	100	3.9
HV-608	2									
HV-612	3									
HV-616	4									
HV-620	5									
HV-624	6									
1" PITCH 61 type HV										
HV-808	2	1" (25.40)	13.7	27.8	41.2	47.4	56.8	57.7	178	6.8
HV-812	3									
HV-816	4									
HV-820	5									
HV-824	6									
1.1/2" PITCH 61 type HV										
HV-1212	3	1 1/2" (38.10)	20.6	41.8	66.6	72.8	89.2	85.2	400	15.5
HV-1216	4									
HV-1220	5									
HV-1224	6									
HV-1232	8									
2" PITCH 61 type HV										
HV-1612	3	2" (50.80)	27.4	55.7	63.7	72.0	86.4	87.0	534	20.5
HV-1616	4									
HV-1620	5									
HV-1624	6									
HV-1632	8									

For notes see page 80

Tel +44(0) 121 360 0155

Fax +44(0) 121 325 1079

Email sales@crossmorse.com

HV Chain Sprocket Dimensions



HV Sprockets

Cross+Morse can provide a full range of HV Sprockets manufactured in the best combination of materials and heat treatment to ensure long service life with ability to transmit full designed torques and powers with minimum noise and vibration.

Sprockets up to 30 teeth and below are usually manufactured from low carbon alloy steels with teeth carburised and sprockets hardened to provide maximum wear resistance with high core strength, larger sprockets are produced in medium carbon steel with induction hardened teeth, or meehanite castings.

It is recommended that a minimum 25 tooth sprockets be used in all drives to provide best efficiency, smooth transmission and low noise levels, however, all sizes of chain can operate on sprockets down to 19 teeth, but such drive designs should always be referred to Cross+Morse. It is preferred practice to use sprockets with odd numbers of teeth, but for 1:1 ratio even teeth sprockets should always be used for optimum chain life and performance.

Sprocket Dimensions

Detailed dimensions for all sizes of sprockets can be supplied on request, including blank dimensions and material specifications for customers wishing to supply their own blanks for teeth cutting only.

The following sprocket design information can be used for initial design and selection.

Sprocket Face Widths, Groove Dimensions, and Maximum Hub

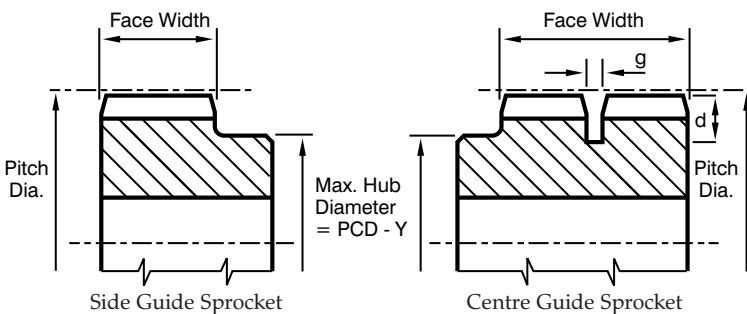

Side Guide Imperial Width HV Chain Sprocket Dimensions

Chain Width Inches	Chain Pitch Size							
	HV3	HV4	HV6/139	HV8/139	HV6	HV8	HV12	HV16
3/4"	16.76	16.76						
1"	22.86	22.86						
1 1/4"	29.21	29.21						
1 1/2"	35.56	35.56	33.53		29.72			
2"	48.26	48.26	46.23	44.45	42.16	38.10		
3"	73.66	73.66	71.63	69.85	67.56	63.50	63.50	59.44
4"	99.06	99.06	97.03	95.25	92.56	88.90	88.90	84.84
5"			122.43	120.65	118.56	114.30	114.30	110.24
6"				146.05	143.76	139.70	139.70	136.64
8"							190.50	187.44
Y	16.5	21.5	30.6	43.5	26.0	36.5	53.8	71.5

Side Guide Chain Sprocket Face-Width Tolerance +0.0 -0.5mm

Sprocket Mounting and Alignment

Sprocket Mounting

To ensure smooth transmission of torque, sprockets should be mounted on shafts with a light interference-fit. A positive mechanical connection is necessary for torque-transmission, with standard side-fitting keys or close fit involute splines being satisfactory. Compression connecting rings and expanding bushes can also be used subject to meeting torque and concentricity requirements; but split tapered bushes must never be used to mount HV sprockets.

For maintenance of alignment it is recommended that sprockets are located positively against a shoulder or step on the shaft. This method of mounting does permit the use of 'A' type platewheels to simplify design and minimise costs.

Sprocket Alignment and Concentricities

Shafts must be parallel in both planes within 0.4mm/Metre of bearing mounting distance. Offset from the machined face on tooth side to the corresponding face of other sprocket should ideally be zero, and otherwise limited to value 'K' mm in table.

When mounted on shafting sprockets should be concentric to within 0.15mm or 0.1% Pitch Diameter T.I.R.; and have maximum face runout of 0.25mm or 1% Pitch Diameter T.I.R.

Pitch Circle Diameter and Maximum Shaft Size

$$PCD = \frac{PN}{\pi} \secant \frac{180^\circ}{N}$$

where N = No. of teeth in Sprocket

P = Pitch of Chain

Maximum Hub Dia. = PCD - Y

where Y = factor - see tables

Bore diameter for keyed shafts should not exceed 67%.
Hub Diameter on Steel Sprockets and 57% on Cast Sprockets.

Centre Guide HV Chain Sprocket Dimensions

Chain Width mm	Chain Pitch Size			
	HV 3	HV 4	HV 6	HV 8
15	12.0*			
17	13.5*			
20	16.5*	16.5*		
25	30.0	30.0		
30	35.0	35.0	26.0*	
35			40.0	
40	45.0	45.0	45.0	50.0
50	55.0	55.0	55.0	60.0
65	70.0	70.0	70.0	75.0
75		80.0		85.0
85			90.0	
100		105.0	105.0	110.0
125			130.0	135.0
150			155.0	160.0
200			205.0	210.0
d	6.0	7.0	12.0	15.0
g	3.0	3.0	4.0	6.0
Y	16.5	21.5	26.0	36.5

* These Sprockets are without groove for side guide Chains
Dimensions for Centre Guide Chains are Minimum

Chain Pitch Inches	3/8"	1/2"	3/4"	1"	1 1/2"	2"
K mm	0.55	0.63	0.78	0.91	1.11	1.29

Tel +44(0) 121 360 0155

Fax +44(0) 121 325 1079

Email sales@crossmorse.com

HV Chain Sprocket Dimensions



Email sales@crossmorse.com
 Fax +44(0) 121 325 1079
 Fax +44(0) 121 360 0155
 Tel +44(0) 121 360 0155

Standard HV Chain Sprockets

Generally HV Chain drives, by their very nature, require custom designed sprocket, which impose delays in the delivery of initial orders or prototype drives. To enable fast delivery of complete drives, a range of standard sprockets is offered for $\frac{3}{8}$ " and $\frac{1}{2}$ " pitch chain. These sprockets can be quickly modified to suit customers specific designs, and thus provide the ideal solution for one-off or prototype drives.

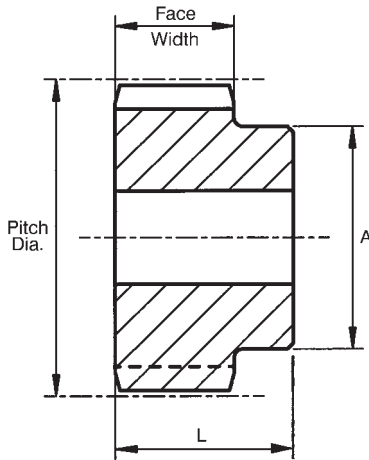

Standard Sprockets for $\frac{3}{8}$ " pitch HV3 Series Chains

3/8" FACE WIDTH for HV303 CHAIN							
No. Teeth	Catalogue No.	Pitch Dia.	Min. Plain Bore	Max. Bore	Hub Dia. A	L.T.B. L	Appr. Wt.
19	HV303B19	57.86	12.70	30	41	35.7	0.40
21	HV303B21	63.91	12.70	33	48	35.7	0.55
23	HV303B23	69.95	12.70	35	54	35.7	0.65
25	HV303B25	76.00	19.05	42	60	35.7	0.80
27	HV303B27	82.04	19.05	45	67	35.7	1.00
29	HV303B29	88.09	19.05	46	73	35.7	1.15
31	HV303B31	94.16	19.05	53	79	35.7	1.40
38	HV303B38	115.34	19.05	73	100	35.7	2.25
42	HV303B42	127.46	19.05	84	112	35.7	2.85
57	HV303B57	172.90	31.75	115	152	35.7	5.30
76	HV303B76	230.48	31.75	115	152	35.7	7.55

1" FACE WIDTH for HV304 CHAIN							
No. Teeth	Catalogue No.	Pitch Dia.	Min. Plain Bore	Max. Bore	Hub Dia. A	L.T.B. L	Appr. Wt.
19	HV304B19	57.86	12.70	30	41	41.3	0.50
21	HV304B21	63.91	12.70	33	48	41.3	0.65
23	HV304B23	69.95	12.70	35	54	41.3	0.80
25	HV304B25	76.00	19.05	42	60	41.3	0.95
27	HV304B27	82.04	19.05	45	67	41.3	1.16
29	HV304B29	88.09	19.05	46	73	41.3	1.40
31	HV304B31	94.16	19.05	53	79	41.3	1.65
38	HV304B38	115.34	19.05	73	100	41.3	2.65
42	HV304B42	127.46	19.05	84	112	41.3	3.35
57	HV304B57	172.90	31.75	115	152	41.3	6.20
76	HV304B76	230.48	31.75	115	152	41.3	9.35

1 1/2" FACE WIDTH for HV306 CHAIN							
No. Teeth	Catalogue No.	Pitch Dia.	Min. Plain Bore	Max. Bore	Hub Dia. A	L.T.B. L	Appr. Wt.
19	HV306B19	57.86	12.70	30	41	54.8	0.65
21	HV306B21	63.91	12.70	33	48	54.8	0.85
23	HV306B23	69.95	12.70	35	54	54.8	1.10
25	HV306B25	76.00	19.05	42	60	54.8	1.25
27	HV306B27	82.04	19.05	45	67	54.8	1.55
29	HV306B29	88.09	19.05	46	73	54.8	1.85
31	HV306B31	94.16	19.05	53	79	54.8	2.45
38	HV306B38	115.34	19.05	73	100	54.8	3.55
42	HV306B42	127.46	19.05	84	112	54.8	4.40
57	HV306B57	172.90	31.75	115	152	54.8	8.25
76	HV306B76	230.48	31.75	115	152	54.8	13.10

Standard Sprockets have hardened teeth for maximum life, but bores are left soft to enable finish machining to customers requirements. Sprockets can be supplied finished bored, keyed or splined. 76 tooth sprockets are cast meehanite manufacture, all others are from carburised low carbon steel.

Standard Sprockets for $\frac{1}{2}$ " pitch HV4 Series Chains

1" FACE WIDTH for HV404 CHAIN							
No. Teeth	Catalogue No.	Pitch Dia.	Min. Bore Dia.	Max. Bore	Hub Ø A	L.T.B. L	Approx. Wt.
19	HV404B19	77.16	12.70	37	56	50.8	1.15
21	HV404B21	85.22	12.70	43	63	50.8	1.50
23	HV404B23	93.27	19.05	46	73	50.8	1.80
25	HV404B25	101.32	19.05	53	81	50.8	2.20
27	HV404B27	109.40	19.05	60	89	50.8	2.65
29	HV404B29	117.47	19.05	65	97	50.8	3.15
31	HV404B31	125.53	19.05	70	106	63.5	4.55
38	HV404B38	153.80	19.05	95	134	63.5	7.30
42	HV404B42	169.95	19.05	111	150	63.5	9.15
57	HV404B57	230.53	31.75	114	152	63.5	12.30
76	HV404B76	307.31	25.40	64	92	50.8	14.10

1 1/2" FACE WIDTH for HV406 CHAIN							
No. Teeth	Catalogue No.	Pitch Dia.	Min. Bore Dia.	Max. Bore	Hub Ø A	L.T.B. L	Approx. Wt.
19	HV406B19	77.16	12.70	37	56	63.5	1.50
21	HV406B21	85.22	12.70	43	63	63.5	1.95
23	HV406B23	93.27	19.05	46	73	63.5	2.30
25	HV406B25	101.32	19.05	53	81	63.5	2.85
27	HV406B27	109.40	19.05	60	89	63.5	3.45
29	HV406B29	117.47	19.05	65	97	63.5	4.10
31	HV406B31	125.53	19.05	70	106	76.2	5.60
38	HV406B38	153.80	19.05	95	134	76.2	8.95
42	HV406B42	169.95	19.05	111	150	76.2	11.15
57	HV406B57	230.53	31.75	114	152	76.2	16.00
76	HV406B76	307.31	25.40	64	92	63.5	20.90

2" FACE WIDTH for HV408 CHAIN							
No. Teeth	Catalogue No.	Pitch Dia.	Min. Bore Dia.	Max. Bore	Hub Ø A	L.T.B. L	Approx. Wt.
19	HV408B19	77.16	12.70	37	56	76.2	1.85
21	HV408B21	85.22	12.70	43	63	76.2	2.35
23	HV408B23	93.27	19.05	46	73	76.2	2.85
25	HV408B25	101.32	19.05	53	81	76.2	3.50
27	HV408B27	109.40	19.05	60	89	76.2	4.15
29	HV408B29	117.47	19.05	65	97	76.2	4.95
31	HV408B31	125.53	19.05	70	106	76.2	5.75
38	HV408B38	153.80	19.05	95	134	76.2	9.10
42	HV408B42	169.95	19.05	111	150	76.2	11.40
57	HV408B57	230.53	31.75	114	152	88.9	19.80
76	HV408B76	307.31	25.40	64	92	76.2	27.50

3" FACE WIDTH for HV412 CHAIN							
No. Teeth	Catalogue No.	Pitch Dia.	Min. Bore Dia.	Max. Bore	Hub Ø A	L.T.B. L	Approx. Wt.
19	HV412B19	77.16	19.05	37	56	102.0	2.40
21	HV412B21	85.22	19.05	43	63	102.0	3.15
23	HV412B23	93.27	19.05	46	73	102.0	3.90
25	HV412B25	101.32	19.05	53	81	102.0	4.75
27	HV412B27	109.40	19.05	60	89	102.0	5.70
29	HV412B29	117.47	19.05	65	97	102.0	6.65
31	HV412B31	125.53	19.05	70	106	102.0	7.85
38	HV412B38	153.80	19.05	95	134	102.0	12.30
42	HV412B42	169.95	19.05	111	150	102.0	15.40
57	HV412B57	230.53	31.75	114	152	114.0	27.30
76	HV412B76	307.31	25.40	64	92	102.0	37.75

All dimensions are in mm

Custom Designed Sprockets

Cross+Morse can manufacture Sprockets for all HV Chains with diameters to 1500mm and face width to 250mm; to custom drawings or to our own design to meet customers requirements. Sprockets can also be Gearcut and finished on Customer blanks. The purchase of Chain and Sprocket together ensures optimum performance and service life.

Package Drive Design

Our design team can assist in selection, detail design of sprockets, shafting etc. on all Inverted Tooth drives ensuring correct application of Chains. We can also offer a complete supply package of Chain, Sprockets and Shafting contained in a rigid Chainless specifically designed to suit individual Customer requirements. Call us now for the best Drive Solution.

HV Chain Installation and Lubrication



Tel +44(0) 121 360 0155

Fax +44(0) 121 325 1079

Email sales@crossmorse.com

HV Chain Installation

HV Chains can be furnished rivetted endless, or open ended for connection with a standard connecting pin set. In some case designs, bearing carriers are large enough to install sprockets and endless chain through the openings. Other designs employ housings which are split at the shaft centre to facilitate installation. If chain is installed open ended, the procedures below may be used.

Connecting Chain using Sprocket

Bring ends of chain together on top of larger sprocket in mesh with sprocket teeth, and then insert connecting pin set.

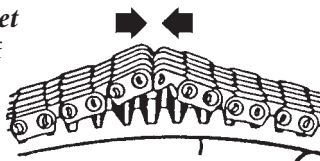

Connecting Chain between Sprocket

On pre-loaded, fixed centre distance drives a hook-up tool similar to that shown may be used to bring ends together.

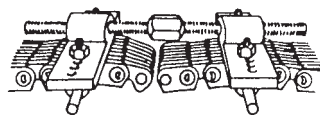

Fitting Connecting Pin

When connecting the open ends with a pin set, it is important that the longer pin of the set must sit nearest to the outside flank of the guide plate. Spirol pin type connectors are normally used for connecting open ended chains. The spirol pin is driven into each end of the pin with a drift, for rivet type connectors. Washers are used on chains of 3/4" and above pitch of the original design 61-115 series chain.

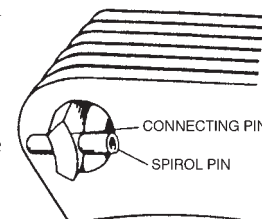

Chain Case Structures

Morse HV Drives are normally on applications where high speed and/or high horsepower transmission is the requirement. The HV Drive should be installed in rigid housings of welded steel or cast construction, complete with shafts, bearings, seals and a proper lubrication system, in order to realise the full performance capability. There should be adequate clearance in chain case for chain to ride over sprockets (min. rad. = Spkt pitch rad + 1/4 chain pitch); and for centrifugal expansion of chain midway between sprockets (allow 12% Centre Distance beyond chain path each side of chain case). Side clearance beyond width of the chain should be equal to or greater than chain pitch.

Lubrication

A proper lubrication system with clean oil of the correct type is necessary for long, quiet, trouble free life of HV Drives. The lubricant must penetrate the chain joints to dissipate frictional heat and flush out foreign particles, and lubricate the surfaces of chain and sprocket contact.

Pressure Lubrication

For chain speeds above 13M/sec, pressure lubrication is required. The lubrication system should supply filtered oil at 4.5 litres/min. per 25mm width of chain. Spray pipes of 9.5mm I.D. with 2.5mm dia. orifices every 25mm will provide adequate lubrication with oil of SAE 20W or less at pressure of 1.5 Bar. The spray pipe should be located to spray onto the inside of chain as slack strand enters sprocket. A replacement element full flow oil filter capable of removing particles larger than 25 microns, with a built in relief valve, should be installed between the oil pump and spray pipe. A low oil pressure switch with warning is recommended. Additional components should include an oil sump strainer, oil fill/breather, magnetic drain plug and an oil level sight gauge. Lubrication should also be provided to the shaft bearings.

Bath Lubrication

At chain speeds below 13M/sec bath lubrication may be satisfactory. With bath lubrication, the dynamic oil level should be maintained at the lowest point of the chain pitch line, and for this purpose an oil level sight gauge is desirable.

Lubrication Oil Specification

Satisfactory HV chain drive performance depends upon the use of well refined, high quality oil. The best lubricant is Automatic Transmission Fluid (ATF), but light detergent oils as used in Automotive Engines, and Turbine and Spindle Oils are also acceptable. Multiple viscosity oils, gear oils or EP compound oils should not be used. For maximum performance, use oils with SAE Grade related to operating temperature in chart.

Oil Viscosity Recommendations

Surrounding Ambient Temp.	SAE Grade Viscosity	Viscosity Saybolt Secs at 38 °C
Under 4 °C	SAE 5*	150 SSU
4 °C to 32 °C	SAE 10*	200 SSU
Over 32 °C	SAE 20	300 SSU

*Use Type A or B Automatic Transmission Fluid (ATF)

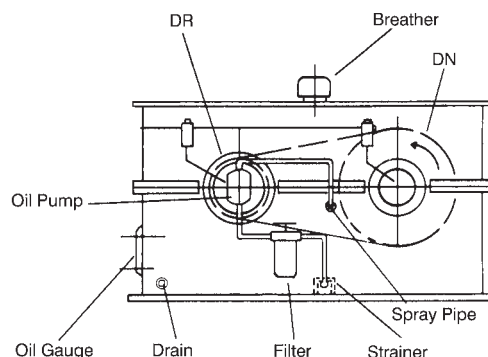

Where applications require oil in excess of SAE 20 Grade consult Morse Engineering

It is desirable to limit oil temperature to 80 °C to prevent rapid deterioration. If necessary external cooling fans or oil cooler should be used to achieve this. Generally HV Chains operate with a temperature rise of approx. 25 °C above ambient temperature.

Lubrication Changes

Oil should be kept clean to assure long trouble free service. If oil becomes dirty or appears to be contaminated it should be replaced. Good practice is to change oil every 1000 hours or 4 months whichever occurs first, but longer intervals are acceptable if operating conditions allow. When oil is changed, the case should be drained and flushed with suitable solvent. Inspection of lubrication piping, pump and spray pipe orifices should be made, and filter element replaced if dirty. The drive must be kept free of water and foreign material at all times.

SC03 - 3/16" Pitch Round Pin Inverted Tooth Chains



The 3/16" pitch 'SC' chains use a simple round pin construction for maximum strength and durability. Chains are available in both centre guide and single outside guide constructions in all widths, but it is normal for narrow width chains to be outside guide. The chains articulate fully on the pin, and as such tensioners can be used on the back of the chain; also the chains can be built with sets of teeth opposed to one another for serpentine drives. Tiny drives can be achieved with these chains, with power capacity up to 4 kW, and operating speeds to 10,000 rpm. All 3/16" pitch inverted tooth chain sprockets are manufactured to customer requirements, normally manufactured from induction hardened steel. Complete chain drive design and fabrication is available to meet your individual requirements. A range of Stainless Steel chains is also available for use in Food Process and Handling Machinery. These chains are manufactured from hardened, corrosion resistant, 304 grade Stainless Steel.



Chain lengths must be of even number of pitches, as offset links are not available with these series of chains.

Typical Applications

- Check Weighers - used to convey product over scales
- Postage Machinery - high operating speeds possible
- Copying Machines - transmit high loads in confined space
- Aircraft Controls - Accurate transfer of motion
- Machine Tools - Compact high torque drives
- Conveyors - handling hot small components

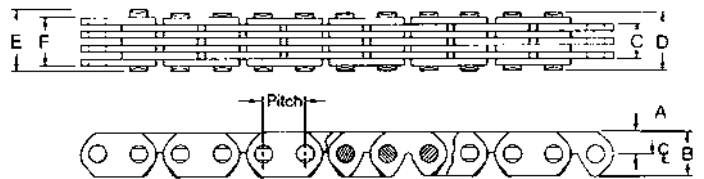

Chain Dimensions - 3/16" SC Series Chains

'SC' Chain Designation	Nominal Width Inches	Chain Pitch ins(mm)	Chain Ht. over Spkt. PCD A mm	Chain Height B mm	Guide Type	Width between Guide Links C mm	Width over Links F mm	Width over Rivet Pin D mm	Width over Conn Pins E mm	Average U.T.S. kN	Ave. Weight per Metre kg
R0305	5/32				CG		4.0	5.1	6.3	2.22	0.1
SC0305	5/32				SOG	2.4	4.0	5.1	6.3	2.22	0.1
R0307	7/32				CG		5.6	6.7	7.9	3.34	0.2
SC0307	7/32				SOG	4.0	5.6	6.7	7.9	3.34	0.2
R0309	9/32				CG		7.1	8.2	9.4	4.45	0.2
SC0309	9/32				SOG	5.6	7.1	8.2	9.4	4.45	0.2
R0311	11/32	3/16"	2.4	5.1	CG		8.7	9.8	11.0	5.56	0.2
SC0311	11/32	(4.76)			SOG	7.1	8.7	9.8	11.0	5.56	0.2
SC0315	15/32				SOG	10.3	11.9	13.0	14.2	7.78	0.3
R0315	15/32				CG		11.9	13.0	14.2	7.78	0.3
SC0319	19/32				CG		15.1	16.2	17.4	10.00	0.4
R0319	19/32				SOG	13.5	15.1	16.2	17.4	10.00	0.4
SC0325	25/32				CG		19.8	20.9	22.1	13.35	0.5
R0325	25/32				SOG	18.3	19.8	20.9	22.1	13.35	0.5
SC0331	31/32				CG		24.6	25.7	26.9	16.70	0.6
R0331	31/32				SOG	23.0	24.6	25.7	26.9	16.70	0.6

Standard Chains are in bold typeface

Chain Dimensions - 3/16" SC Series Stainless Steel Chains

'SC' Chain Designation	Nominal Width Inches	Chain Pitch ins(mm)	Chain Ht. over Spkt. PCD A mm	Chain Height B mm	Guide Type	Width between Guide Links C mm	Width over Links F mm	Width over Rivet Pin D mm	Width over Conn Pins E mm	Average U.T.S. kN	Ave. Weight per Metre kg
SC0305SS	5/32				SOG	2.4	4.0	5.1	6.3	2.00	0.1
SC0307SS	7/32				SOG	4.0	5.6	6.7	7.9	3.34	0.2
SC0309SS	9/32				SOG	5.6	7.1	8.2	9.4	4.45	0.2
SC0311SS	11/32				SOG	7.1	8.7	9.8	11.0	5.56	0.2
SC0315SS	15/32	3/16"	2.4	5.1	SOG	10.3	11.9	13.0	14.2	7.78	0.3
R0315SS	15/32	(4.76)			CG		11.9	13.0	14.2	7.78	0.3
SC0319SS	19/32				CG		15.1	16.2	17.4	10.00	0.4
R0319SS	19/32				SOG	13.5	15.1	16.2	17.4	10.00	0.4
SC0325SS	25/32				CG		19.8	20.9	22.1	13.35	0.5
R0325SS	25/32				SOG	18.3	19.8	20.9	22.1	13.35	0.5
SC0331SS	31/32				CG		24.6	25.7	26.9	16.70	0.6
R0331SS	31/32				SOG	23.0	24.6	25.7	26.9	16.70	0.6

Email sales@crossmorse.com Fax +44(0) 121 325 1079 Tel +44(0) 121 360 0155

American Standard SC Series Inverted Tooth Chains



Tel +44(0) 121 360 0155 Fax +44(0) 121 325 1079

Cross+Morse 'SC' Series Inverted Tooth chains are manufactured to meet the American Standards ASME(ANSI) B29.2, and will operate on Sprockets manufactured to that Standard. Chains of other manufacture, often identified with letters 'SC' stamped on the outer plates, can be replaced, but only as complete chains, because the ASME Standard allows manufacturers individual design within the concept, so although all chains will operate on the standard sprockets, chains from different manufacturers will not usually connect together. All Cross+Morse chains use the Pin and Rocker design developed in the 'HV' series chains, so eliminating friction and chordal action during articulation allowing the chains to me operated at speeds up to 35 metres/sec, with negligible wear or heat generation. Improved Link design combined with the 'HV' type pins has enabled higher loads to be transmitted, with the chains having twice the power capacity specified in the Standard. The improved Link design reduces stress concentrations giving improved fatigue life and increased tensile strength. Innovative stamping methods in link production maximise the bearing surface area of each link, reducing stress in the chain joint, and chain elongation when operating. All chain links are shot peened to improve fatigue resistance and provide a uniform finish.

The new series 'SC' chains suffer minimal wear elongation during operation, making them well suited to 'fixed centre' drive applications. The chains can also be used to replace other manufacturers chains on existing applications to increase power ratings.

The 'SC' chains are available in standard Centre Guide construction, as shown in the following table; or with either Single or Double Outside Guides, as shown in tables on pages 87/88. Other widths and guiding arrangements from the standards shown can be supplied as replacements on existing drives on short lead time.

Our Standard 'SC' Chains are not suitable for Conveying applications, due to the curved back of the links. We are also able to offer an earlier series of chains, which do have flat back surface, to fit SC Sprockets. This 'Original Series SC Chain' is available to order on chains up to 1" pitch. Round Pin chain is also available to request in 3/8" to 3/4" pitch, for applications requiring to run on small sprockets, or subject to back-bending in operation.

It is desirable on all Inverted Tooth Chain drives to design installations so that chains have an even number of pitches, but on 'SC' if this is not possible we can provide Offset (Hunting) Link sets to accommodate odd pitch length chains. Chains will normally be supplied in requested length complete with Cotter Pin Joining Pin, but can also be supplied rivetted endless if required.

3/8" through to 2" Pitch

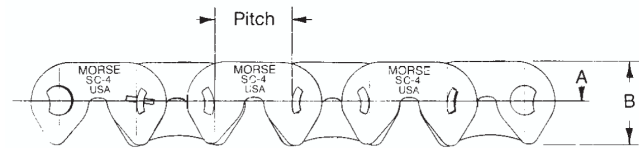
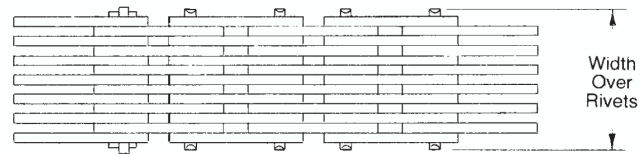
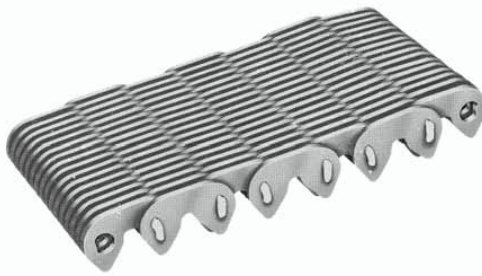

Chain Dimensions - SC Series Centre Guide Chains Imperial Widths

'SC' Chain Designation	Nominal Width Inches	Chain Pitch ins(mm)	Chain Ht. over Spkt. PCD A mm	Chain Height B mm	Guide Type	Width over Links F mm	Width over Rivet Pin D mm	Width over Drilled Pins E mm	Average U.T.S kN	Ave. Weight per Metre kg
R302†	1/2	3/8" (9.525)	5.6	10.7	CG	14.3	16.3	17.8	17	0.7
SC303	3/4				CG	20.6	22.6	24.0	25	1.0
SC304	1				CG	27.0	29.0	30.5	33	1.3
SC305	1.1/4				CG	33.4	35.3	36.8	42	1.6
SC306	1.1/2				CG	39.8	41.7	43.2	50	1.9
SC307	1.3/4				CG	46.2	48.1	49.6	67	2.2
SC308	2				CG	52.5	54.4	55.9	75	2.5
SC310	2.1/2				CG	65.3	67.2	68.8	83	3.1
SC312	3				CG	78.1	80.0	81.5	100	3.7
SC316	4				DCG*	103.6	105.6	107.2	133	4.9
SC403	3/4	1/2" (12.70)	7.6	14.2	CG	20.6	23.6	25.4	33	1.3
SC404	1				CG	27.0	30.0	32.0	44	1.7
SC405	1.1/4				CG	33.4	36.3	38.1	56	2.1
SC406	1.1/2				CG	39.8	42.7	44.5	67	2.5
SC407	1.3/4				CG	46.2	49.0	51.0	78	2.9
SC408	2				CG	52.5	55.4	57.2	89	3.3
SC410	2.1/2				CG	65.3	68.1	70.1	111	4.1
SC412	3				CG	78.1	80.9	82.8	133	4.9
SC414	3.1/2				CG	90.8	93.7	95.5	156	5.7
SC416	4				DCG*	103.6	106.4	108.2	178	6.5
SC420	5	DCG*	129.1	132.1	133.9	222	8.1			
SC424	6	DCG*	154.6	157.5	159.3	267	9.7			
SC428	7	DCG*	180.1	183.0	185.0	356	11.3			

* The Guide Spacing on Double Centre Guide Chains varies by manufacturer, it is thus necessary to provide this dimension when ordering. The dimension can be taken from either the chain to be replaced, or the sprockets, and should be from centre to centre of link or groove.

†SC302 Chain is a Single Side Guide construction chain, see page 87.

Email sales@crossmorse.com

American Standard SC Series Inverted Tooth Chains



Chain Dimensions - SC Series Centre Guide Chains Imperial Widths

'SC' Chain Designation	Nominal Width Inches	Chain Pitch ins(mm)	Chain Ht. over Spkt. PCD A mm	Chain Height B mm	Guide Type	Width over Links F mm	Width over Rivet Pin D mm	Width over Drilled Pins E mm	Average U.T.S kN	Ave. Weight per Metre kg
SC504	1				CG	26.8	33.0	35.0	56	2.5
SC506	1.1/2				CG	39.2	45.3	47.4	83	3.5
SC508	2				CG	51.7	57.7	59.8	111	4.6
SC510	2.1/2	5/8"			CG	64.1	70.1	72.1	139	5.6
SC512	3	(15.88)	9.5	17.8	CG	76.5	82.6	84.6	167	6.7
SC514	3.1/2				CG	88.9	94.7	96.8	195	7.8
SC516	4				CG	101.3	107.2	109.2	222	8.8
SC520	5				CG	126.2	132.0	134.0	278	10.9
SC524	6				CG	151.0	157.0	159.0	334	13.0
SC604	1				CG	26.8	33.6	35.6	67	3.0
SC606	1.1/2				CG	39.2	46.2	48.3	100	4.2
SC608	2				CG	51.7	58.4	60.5	133	5.5
SC610	2.1/2				CG	64.1	71.1	73.2	167	6.8
SC612	3	3/4"			CG	76.5	83.4	85.4	200	8.0
SC614	3.1/2	(19.05)	10.9	21.3	CG	88.9	95.7	97.7	233	9.3
SC616	4				CG	101.3	108.2	110.2	267	10.6
SC620	5				CG	126.2	133.1	135.2	334	13.1
SC624	6				CG	151.0	158.0	160.0	400	15.6
SC628	7				CG	175.9	182.8	184.9	467	18.2
SC632	8				CG	200.7	207.7	209.7	534	20.7
SC806	1.1/2				CG	34.7	44.0	46.8	133	4.9
SC808	2				CG	47.4	57.4	60.2	178	6.5
SC810	2.1/2				CG	60.1	69.7	72.5	222	8.0
SC812	3				CG	72.8	81.0	85.1	267	9.6
SC816	4				CG	98.2	107.4	110.2	356	12.7
SC820	5				CG	123.6	131.6	134.4	445	15.8
SC824	6	1"	15.2	28.4	CG	149.0	156.0	159.8	534	18.9
SC828	7	(25.40)			CG	174.4	188.7	191.5	623	22.0
SC832	8				CG	199.8	213.6	216.4	712	25.1
SC840	10				CG	250.6	263.7	266.4	890	31.3
SC848	12				CG	307.8	316.0	319.0	1068	37.5
SC1212	3				CG	72.9	84.3	84.3	400	14.0
SC1216	4				CG	98.4	108.7	108.7	534	18.6
SC1220	5				CG	123.8	134.1	134.1	667	23.1
SC1224	6				CG	149.3	159.5	159.5	801	27.7
SC1228	7	1/1/2"	22.8	42.7	CG	174.7	184.9	184.9	934	32.2
SC1232	8	(38.10)			CG	200.1	210.6	210.6	1068	36.7
SC1236	9				CG	225.6	236.5	236.5	1201	41.3
SC1240	10				CG	254.2	264.7	264.7	1334	45.8
SC1616	4				CG	98.2	110.2	110.2	712	24.7
SC1620	5				CG	123.6	135.6	135.6	890	30.8
SC1624	6				CG	149.0	161.0	161.0	1068	36.8
SC1628	7	2"	30.4	57.0	CG	174.4	186.4	186.4	1246	42.9
SC1632	8	(50.80)			DCG*	199.8	211.8	211.8	1423	48.9
SC1640	10				DCG*	250.6	262.6	262.6	1779	61.1
SC1648	12				DCG*	301.4	313.4	313.4	2135	73.2
SC1656	14				DCG*	358.6	370.6	370.6	2491	85.3
SC1664	16				DCG*	409.4	421.4	421.4	2847	97.4

* The Guide Spacing on Double Centre Guide Chains varies by manufacturer, it is thus necessary to provide this dimension when ordering. The dimension can be taken from either the chain to be replaced, or the sprockets, and should be from centre to centre of link or groove

For Installation and Lubrication information refer to HV data on page 83. For any further Technical information contact our Technical Sales Dept. at Birmingham.

Order Information

If chain part number not available when ordering replacement chain, the following information should be supplied.

- | | |
|--|--|
| 1. Chain Pitch Distance between centres of Teeth Tips when chain laid flat. | 4. Inside Width Outside guide chains only, distance between guides. |
| 2. Chain Width Distance over Link Plates. | 5. Pin Length Length of rivet and connecting pins, if clearance critical. |
| 3. Guiding Centre or Outside Guide. | 6. No. Pitches No. pitches of chain which make closed chain. |

If the chain you require to replace is not shown above, or you require assistance in identification or drive design, contact our Technical Sales Dept.

Formulae and Conversion Factors



Useful formulae in Power Transmission Calculations

1. Motor Power (kw) $P = \frac{T \times n}{9550}$
2. Torque (Nm) $T = \frac{9550P}{n}$
3. For Solid Cylinder Inertia (kg m²) $I = \frac{md^2}{800} \times 10^4 = \frac{\pi lqd^4}{32000} \times 10^{-6}$
4. For Hollow Cylinder Inertia (kg m²) $I = \frac{m(da^2 - di^2)}{800} \times 10^4 = \frac{\pi lq (da^4 - di^4)}{32000} \times 10^{-6}$
5. Flywheel Inertia GD² (kp m²) $\cong 4 \times I$
6. Acceleration Torque (Nm) $T_a = \frac{0.105 I_t (n_2 - n_1)}{t_a}$
7. Total drive Torque (Nm) $T_t = T_a + T_L$
also $T_t = \frac{KT_s + T_L}{1 + K}$ where $K = \frac{I_L + I_t}{I_d}$
8. Tooth & Belt/Chain drive speed m/Sec $V = \frac{Z \times p \times n}{60,000}$
9. Pull in Belt/chain (N) $FL = \frac{P \times 1000}{V}$
10. Centrifugal Pull Belt/Chain $F_c = WV^2$

Where

d	=	diameter - mm	p	=	chain/belt pitch - mm
da	=	outside diameter - mm	P	=	Power - kw
di	=	inside diameter - mm	q	=	density - kg/cm ³
F _c	=	Centrifugal - Newtons	t _a	=	time acceleration - secs
F _L	=	Load (Power) Pull - Newtons	T	=	Torque - Nm
I	=	Inertia - kgm ²	T _a	=	Acceleration Torque - Nm
I _d	=	Inertia of Driver - kgm ²	T _L	=	Load Torque - Nm
I _L	=	Inertia of Load - kgm ²	T _s	=	Motor Starting Torque - Nm
I _t	=	Total Inertia - kgm ²	T _t	=	Total Torque - Nm
l	=	length - mm	V	=	Velocity - m/Sec
m	=	mass - kg	W	=	Weight - kg/m
n	=	rotational speed - r.p.m.	Z	=	No. Teeth in Pulley
n ₂ - n ₁	=	change in speed - r.p.m.			

Conversion Factors

LENGTH	mm	×	0.03937	=	INCHES	×	25.4	=	mm
	METRES	×	3.2808	=	FEET	×	0.3048	=	METRES
WEIGHT	kg	×	2.2046	=	POUND f	×	0.4536	=	kg
FORCE	N (Newton)	×	0.2248	=	POUND f	×	4.4482	=	N
	N (Newton)	×	0.1019	=	kg f	×	9.807	=	N
TORQUE	Nm	×	0.7376	=	lb f ft	×	1.356	=	Nm
	kgfm	×	9.8066	=	Nm	×	0.1019	=	kgfm
POWER	kW	×	1.341	=	HP	×	0.7457	=	kW
	kW	×	1.3596	=	PS	×	0.7355	=	kW
INERTIA	kgm ²	×	23.7304	=	lb f ft ²	×	0.04214	=	kgcm ²
	kgcm ²	×	10 ⁻⁴	=	kg m ²	×	10,000	=	kgcm ²
	kgcm ²	×	0.3417	=	lb in ²	×	2.9264	=	kgcm ²
	GD ² kpm	×	0.25	=	kg m ²	×	4.0	=	kpm

Metric Standard Bores and Keyways

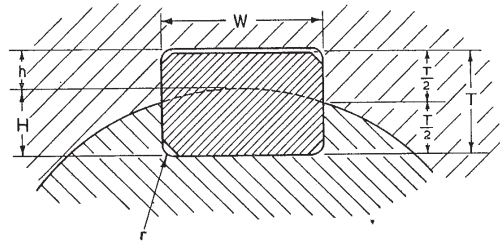

Imperial Keyway Dimensions to BS 46 Pt. 1 - 1958

All dimensions in inches

Diameter of Shaft		Key Size W X T	Key				Keyway to Shaft				Keyway in hub				Nominal Keyway radius & Key chamfer r*
Over	Up to and including		Width W		Thickness T		Width Ws		Depth H		Width Wh		Depth h		
			Max.	Min.	Max.	Min.	Min.	Max.	Min.	Max.	Min.	Max.	Min.	Max.	
1/4	1/2	1/8 x 1/8	0.127	0.125	0.127	0.125	0.124	0.125	0.072	0.078	0.125	0.126	0.060	0.066	0.010
1/2	3/4	3/16 x 3/16	0.190	0.188	0.190	0.188	0.187	0.188	0.107	0.113	0.188	0.189	0.088	0.094	0.010
3/4	1	1/4 x 1/4	0.252	0.250	0.252	0.250	0.249	0.250	0.142	0.148	0.250	0.251	0.115	0.121	0.010
1	1.1/4	5/16 x 1/4	0.314	0.312	0.253	0.250	0.311	0.312	0.146	0.152	0.312	0.313	0.112	0.118	0.010
1.1/4	1.1/2	3/8 x 1/4	0.377	0.375	0.253	0.250	0.374	0.375	0.150	0.156	0.375	0.376	0.108	0.114	0.010
1.1/2	1.3/4	7/16 x 5/16	0.440	0.438	0.315	0.312	0.437	0.438	0.186	0.192	0.438	0.439	0.135	0.141	0.020
1.3/4	2	1/2 x 5/16	0.502	0.500	0.315	0.312	0.499	0.500	0.190	0.196	0.500	0.501	0.131	0.137	0.020
2	2.1/2	5/8 x 7/16	0.627	0.625	0.441	0.438	0.624	0.625	0.260	0.266	0.625	0.626	0.185	0.191	0.020
2.1/2	3	3/4 x 1/2	0.752	0.750	0.503	0.500	0.749	0.750	0.299	0.305	0.750	0.751	0.209	0.215	0.020
3	3.1/2	7/8 x 5/8	0.877	0.875	0.629	0.625	0.874	0.875	0.370	0.376	0.875	0.876	0.264	0.270	0.062
3.1/2	4	1 x 3/4	1.003	1.000	0.754	0.750	0.999	1.000	0.441	0.447	1.000	1.001	0.318	0.324	0.062
4	5	1.1/4 x 7/8	1.253	1.250	0.879	0.875	1.248	1.250	0.518	0.524	1.250	1.252	0.366	0.372	0.062
5	6	1.1/2 x 1	1.504	1.500	1.006	1.000	1.498	1.500	0.599	0.605	1.500	1.502	0.412	0.418	0.062
6	7	1.3/4 x 1.1/4	1.754	1.750	1.256	1.250	1.748	1.750	0.740	0.746	1.750	1.752	0.526	0.532	0.125
7	8	2 x 1.3/8	2.005	2.000	1.381	1.375	1.998	2.000	0.818	0.824	2.000	2.002	0.573	0.579	0.125
8	9	2.1/4 x 1.1/2	2.255	2.250	1.506	1.500	2.248	2.250	0.897	0.905	2.250	2.252	0.619	0.627	0.125
9	10	2.1/2 x 1.5/8	2.505	2.500	1.631	1.625	2.498	2.500	0.975	0.983	2.500	2.502	0.666	0.674	0.187
10	11	2.3/4 x 1.7/8	2.755	2.750	1.881	1.875	2.748	2.750	1.114	1.122	2.750	2.752	0.777	0.785	0.187
11	12	3 x 2	3.006	3.000	2.008	2.000	2.998	3.000	1.195	1.203	3.000	3.002	0.823	0.831	0.187

Metric Keyway Dimensions to BS 4235 Pt. 1 - 1972

Shaft Diameter		Key Width x Thickness WxT mm	Keyway						
Over mm	to mm		Tolerances for class of fit width W				depth		
			nominal width mm	normal shaft mm	fit tol. hub mm	close fit shaft & hub mm	shaft H mm	hub h mm	
6	8	2 x 2	2	-0.04	+0.012	-0.06		1.2 + 0.1	1.0 + 0.1
8	10	3 x 3	3	-0.029	-0.012	-0.031		1.8 + 0.1	1.4 + 0.1
10	12	4 x 4	4	0	+0.015	-0.012		2.5 + 0.1	1.8 + 0.
12	17	5 x 5	5	-0.030	-0.015	-0.042		3.0 + 0.1	2.3 + 0.1
17	22	6 x 6	6					3.5 + 0.1	2.8 + 0.1
22	30	8 x 7	8	0	+0.018	-0.015		4.0 + 0.2	3.3 + 0.2
30	38	10 x 8	10	-0.036	-0.018	-0.051		5.0 + 0.2	3.3 + 0.2
38	44	12 x 8	12					5.0 + 0.2	3.3 + 0.2
44	50	14 x 9	14	0	+0.021	-0.018		5.5 + 0.2	3.8 + 0.2
50	58	16 x 10	16	-0.43	-0.021	-0.061		6.0 + 0.2	4.3 + 0.2
58	65	18 x 11	18					7.0 + 0.2	4.4 + 0.2
65	75	20 x 12	20					7.5 + 0.2	4.9 + 0.2
75	85	22 x 14	22	0	+0.026	-0.022		9.0 + 0.2	5.4 + 0.2
85	95	25 x 14	25	-0.052	-0.026	-0.074		9.0 + 0.2	5.4 + 0.2
95	110	28 x 16	28					10.0 + 0.2	6.4 + 0.2
110	130	32 x 18	32					11.0 + 0.2	7.4 + 0.2
130	150	36 x 20	36					12.0 + 0.3	8.4 + 0.3
150	170	40 x 22	40	0	+0.031	-0.026		13.0 + 0.3	9.4 + 0.3
170	200	45 x 25	45	-0.062	-0.031	-0.088		15.0 + 0.3	10.4 + 0.3
200	230	50 x 28	50					17.0 + 0.3	11.4 + 0.3
230	260	56 x 32	56	0	+0.037	-0.032		30.0 + 0.3	12.4 + 0.3
260	290	63 x 32	63	-0.074	-0.037	-0.106		20.0 + 0.3	12.4 + 0.3

All keyways cut will be to normal fit tolerances to dimensions in above tables unless otherwise specified. Where hub diameters restrict size of key it is common practice to use shallow keys to conform to DIN 6885 Sheet 3.

Tel +44 (0) 121 360 0155

Fax +44 (0) 121 325 1079

Email sales@crossmorse.com



Shady Lane, Great Barr, Birmingham, England B44 9EU
Telephone: +44(0) 121 360 0155
Sales Direct: +44(0) 121 325 2500
Facsimilie: +44(0) 121 325 1079
Email: sales@crossmorse.com
Website: www.crossmorse.com

Power Transmission Solutions

Power Transmission Products

*Roller Chain Drives
Silent Chain Drives
Timing Belt Drives
Clamping Elements
Mounted Bearings
Overload Clutches
Torque Limiters
Stieber Freewheels
Shaft Couplings
Sprag Clutches
Tensioners
Pulleys
Gears
Sprockets*

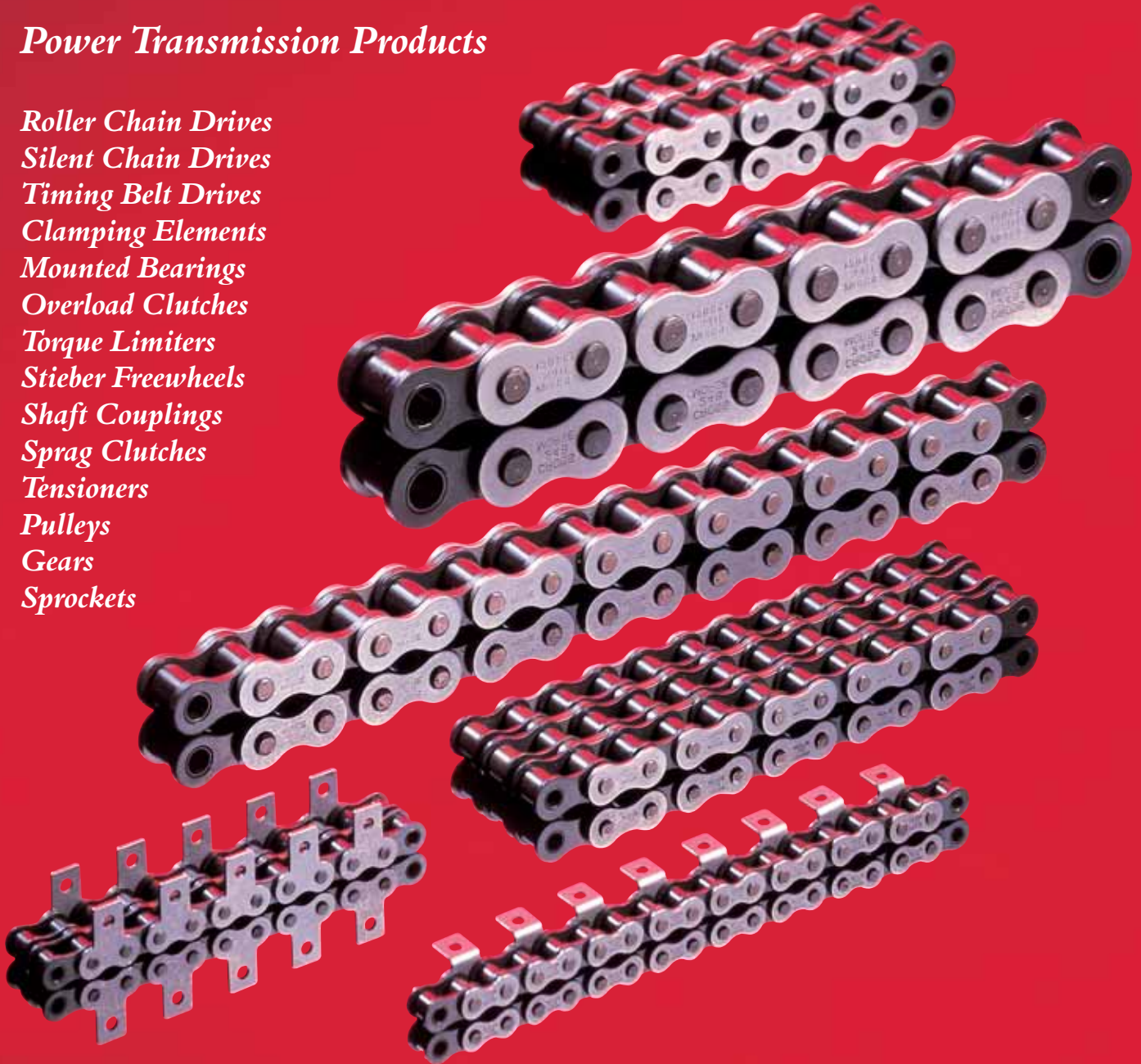

CT09

