

Chains & sprockets	Wear strips	Side guide brackets & accessories	Levelers	Engineering manual
Modular belts & sprockets	Chain & belt return systems	Frame & structure supports	Bearing supports	
Curves & tracks	Side guide solutions	Miscellaneous products	Equipment	

SYSTEM PLAST®

Smart Guide

1 0 1 1 0 a

GENERAL INDEX

www.SystemPlastSmartGuide.com



RegalRexnord™

Chains & sprockets	Wear strips	Side guide brackets & accessories	Levelers	Engineering manual
Modular belts & sprockets	Chain & belt return systems	Frame & structure supports	Bearing supports	
Curves & tracks	Side guide solutions	Miscellaneous products	Equipment	

INTRODUCTION

Smart Guide visual index..... **10110a**
 Smart Guide catalog index..... **10110b**
 How Smart Guide works..... **10110c**
 Smart Guide icon legend..... **10110d**

CHAINS & SPROCKETS

Index metal chains & sprockets..... **11010a**
 Index straight thermoplastic chains & sprockets..... **11011a**
 Index sideflexing thermoplastic chains & sprockets..... **11012a**
 Index other types sideflexing chains & sprockets..... **11013a**

MODULAR BELTS & SPROCKETS

Index straight modular belts & sprockets..... **30010a**
 Index sideflexing modular belts & sprockets..... **30012a**
 Index ½" pitch (12,7mm) -Thickness: 8,7mm..... **30020a**
 Index ¾" pitch (19mm) -Thickness: 8,7mm..... **30190a**
 Index 1" pitch (25,4mm) -Thickness: 8,7mm..... **30300a**
 Index 1" pitch (25,4mm) -Thickness: 12,7mm..... **30410a**
 Index 1" pitch (25,4mm)..... **30700a**
 Index sideflexing modular belts 2256..... **30728a**

CURVES & TRACKS

Introduction to curves..... **50005a**
 Index magnetic curves..... **50010a**

WEAR STRIPS

Index wear strips..... **50510a**

CHAIN & BELT RETURN SYSTEMS

Index chain & belt return systems..... **51010a**

SIDE GUIDE SOLUTIONS

Index side guides & clamps..... **51510a**
 Index roller side guides & roller transfer plates..... **52510a**

SIDE GUIDE BRACKETS & ACCESSORIES

Index side guides brackets..... **53510a**

FRAME & STRUCTURE SUPPORTS

Index frame & structure supports..... **54010a**

MISCELLANEOUS PRODUCTS

Index miscellaneous products..... **54510a**

LEVELERS

Index levelers & tube ends..... **55510a**

BEARINGS

Index mounted bearings..... **56010a**

EQUIPMENT

Index equipment..... **57010a**

RELATED INFORMATION 

Index related information..... **72010a**

ITEM DESCRIPTION INDEX

Item description index..... **78000a**

STANDARD TERMS AND CONDITIONS OF SALE

Standard terms and conditions of sale..... **79900a**



Chains & sprockets	Wear strips	Side guide brackets & accessories	Levelers	Engineering manual
Modular belts & sprockets	Chain & belt return systems	Frame & structure supports	Bearing supports	
Curves & tracks	Side guide solutions	Miscellaneous products	Equipment	

50570a

CONVEYOR WEAR BED

www.SystemPlastSmartGuide.com

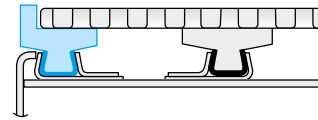
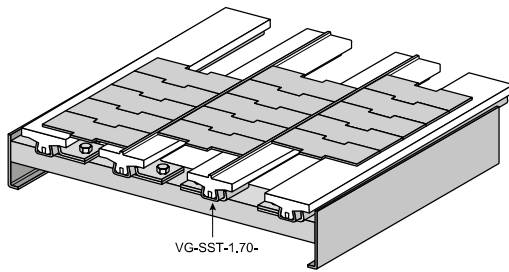

Valu Guide® rail can be used to form a wear bed grid for metal or plastic belts.

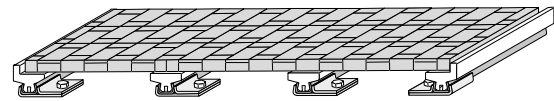
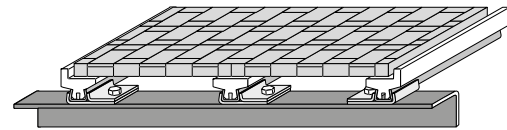
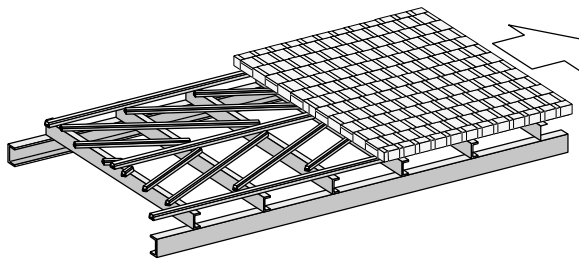

NOTE: For even distribution of load over width of belt, use the same type of guide through out your application.

Go to: 51520a	Go to: 51520b	Go to: 51520c

SUPPORT FOR CHAIN AND BELTS

Aluminum and UHMWPE guide rail for stable and ultra low friction guiding and supporting modular conveyor belts. Available in 3M lengths. Minimum radius 457 mm (inside edge). Replaceable UHMWPE strips.

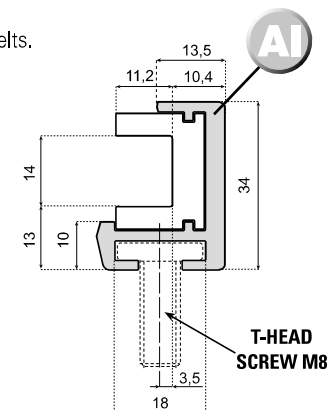
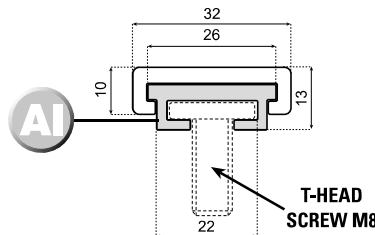
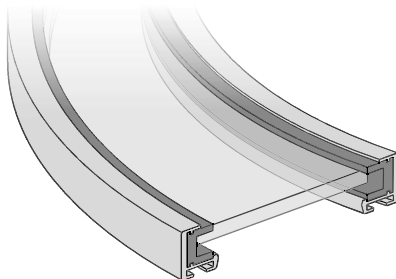

UHMWPE WHITE		
ITEM DESCRIPTION		
VG-BWS-125-10	3 m	30 m

NOLU-S™ GUIDE		
ITEM DESCRIPTION		
VG-MBG-50-NS-10	3 m	30 m

Chains & sprockets	Wear strips	Side guide brackets & accessories	Levelers	Engineering manual
Modular belts & sprockets	Chain & belt return systems	Frame & structure supports	Bearing supports	
Curves & tracks	Side guide solutions	Miscellaneous products	Equipment	

50580a

WEAR STRIPS

www.SystemPlastSmartGuide.com

See other wear strips:
50580b

See chains infeed:
50600a

Version for inliners:
50610a



continue ►

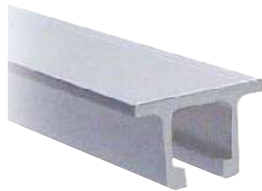

MATERIAL:

- Metal profile in stainless steel AISI 304, AISI 430 or anodized Aluminum.
- Wear strip in UHMWPE or Nolu-S™ wear strips.

CHARACTERISTICS:

- Very low friction coefficient.
- High resistance to chemical agents.
- No liquid absorption.

SUPPLY:

- 3 or 6 meters.

APPLICATION:

- Chain and belt guide.

Information about this product is only available on our Smart Guide® website.



	ITEM DESCRIPTION	ITEM DESCRIPTION	ITEM DESCRIPTION		
	VG-S330M-10	VG-S4-330M-10	-	3 m	30 m
	VG-S330M-20	VG-S4-330M-20	-	6 m	30 m
	-	-	VG-A330M-10	3 m	30 m
	-	-	VG-A330M-20	6 m	30 m

MOQ Min. order quantity: 180m.

	UHMWPE GREEN	UHMWPE BLACK	UHMWPE WHITE	UHMWPE ANTISTATIC BLACK	NOLU-S™ WEAR STRIPS			
	ITEM DESCRIPTION							
	VG-P330CM-G-10	VG-P330CM-B-10	VG-P330CM-W-10 <small>npo</small>	VG-P330CM-SD-10 <small>npo</small>	-	-	3 m	30 m
	VG-P330CM-G-20	VG-P330CM-B-20	VG-P330CM-W-20 <small>npo</small>	VG-P330CM-SD-20 <small>npo</small>	VG-P330CM-NS-20 <small>npo</small>	-	6 m	30 m
	VG-P330CM-G-200	-	-	-	-	60 m	-	60 m
	VG-P330CRM-G-10	VG-P330CRM-B-10 <small>npo</small>	-	VG-P330CRM-SD-10 <small>npo</small>	-	-	3 m	30 m
	VG-P330CRM-G-20	VG-P330CRM-B-20 <small>npo</small>	-	VG-P330CRM-SD-20 <small>npo</small>	-	-	6 m	30 m

continue ►

Chains & sprockets	Wear strips	Side guide brackets & accessories	Levelers	Engineering manual
Modular belts & sprockets	Chain & belt return systems	Frame & structure supports	Bearing supports	
Curves & tracks	Side guide solutions	Miscellaneous products	Equipment	

50580b

WEAR STRIPS

www.SystemPlastSmartGuide.com



See chains infeed:

50600a

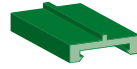

See other wear strips:

50580a

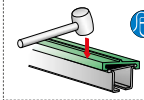

Chains guide wear strips:

50610a



◀ back continue ▶

Information about this product is only available on our Smart Guide® website.



MOQ Min. order quantity: 180m.

		UHMWPE GREEN	UHMWPE BLACK	UHMWPE WHITE	UHMWPE ANTISTATIC BLACK				
		ITEM DESCRIPTION							
	STEEL PROFILE IN AISI 304	VG-SP330CM-G-10	VG-SP330CM-B-10	VG-SP330CM-W-10 m.p.a.	VG-SP330CM-SD-10 m.p.a.	3 m	30 m		
		VG-SP330CM-G-20	VG-SP330CM-B-20	VG-SP330CM-W-20 m.p.a.	VG-SP330CM-SD-20 m.p.a.	6 m	30 m		
		VG-SP330CRM-G-10	VG-SP330CRM-B-10 m.p.a.	-	VG-SP330CRM-SD-10	3 m	30 m		
		VG-SP330CRM-G-20	VG-SP330CRM-B-20 m.p.a.	-	VG-SP330CRM-SD-20 m.p.a.	6 m	30 m		
		VG-S4P330CM-G-10	VG-S4P330CM-B-10	VG-S4P330CM-W-10 m.p.a.	VG-S4P330CM-SD-10 m.p.a.	3 m	30 m		
		VG-S4P330CM-G-20	VG-S4P330CM-B-20	VG-S4P330CM-W-20 m.p.a.	VG-S4P330CM-SD-20 m.p.a.	6 m	30 m		
	STEEL PROFILE IN AISI 430	VG-S4P330CRM-G-10	VG-S4P330CRM-B-10 m.p.a.	-	VG-S4P330CRM-SD-10 m.p.a.	3 m	30 m		
		VG-S4P330CRM-G-20	VG-S4P330CRM-B-20 m.p.a.	-	VG-S4P330CRM-SD-20 m.p.a.	6 m	30 m		
			ALUMINIUM PROFILE	VG-AP330CM-G-10	VG-AP330CM-B-10	VG-AP330CM-W-10 m.p.a.	VG-AP330CM-SD-10 m.p.a.	3 m	30 m
				VG-AP330CM-G-20	VG-AP330CM-B-20	VG-AP330CM-W-20 m.p.a.	VG-AP330CM-SD-20 m.p.a.	6 m	30 m
				VG-AP330CRM-G-10	VG-AP330CRM-B-10 m.p.a.	-	VG-AP330CRM-SD-10 m.p.a.	3 m	30 m
				VG-AP330CRM-G-20	VG-AP330CRM-B-20 m.p.a.	-	VG-AP330CRM-SD-20 m.p.a.	3 m	30 m

NOTE: The profiles on this page are supplied assembled.

◀ back continue ▶

Chains & sprockets	Wear strips	Side guide brackets & accessories	Levelers	Engineering manual
Modular belts & sprockets	Chain & belt return systems	Frame & structure supports	Bearing supports	
Curves & tracks	Side guide solutions	Miscellaneous products	Equipment	

50600a

WEAR STRIPS ACCESSORIES

www.SystemPlastSmartGuide.com

FOR ALUMINUM AND STEEL PROFILE



APPLICATION: rapid wear strip assembly with M6 or M8 screws.

◀ back continue ▶

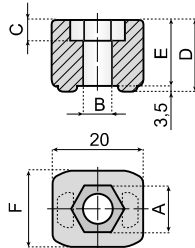

FOR SCREWS		
	M6	M8
A	10	13
B	6,2	8,2
C	4,5	6

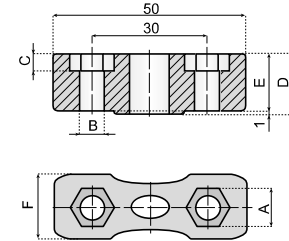

NOTES: screws are not included.

NOTES: screws are not included.

FOR PROFILE	D	E	F	ITEM DESCRIPTION		
				M6	M8	
	16	15	16,5	BCK-S330-M6	BCK-S330-M8	100
	14	10,5	13,5	BCK-A330-M6	-	

FOR PROFILE	D	E	F	ITEM DESCRIPTION		
				M6	M8	
	16	15	16,5	CON-S330-M6	CON-S330-M8	100
	14	10,5	13,5	CON-A330-M6	-	

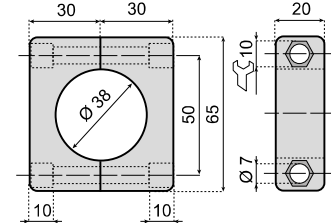
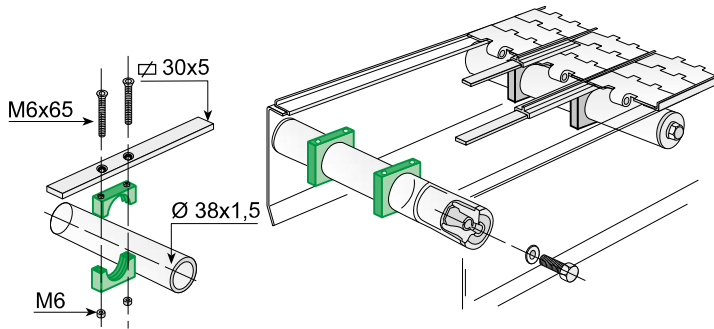

WEARSTRIP CLAMP

APPLICATION: support of wear strip

NOTES: screws are not included.

PA-FG BLACK		
ITEM DESCRIPTION		
CL-6065X38		50

CHAIN INFEEED FOR ALUMINUM AND STAINLESS STEEL PROFILE

TYPE A

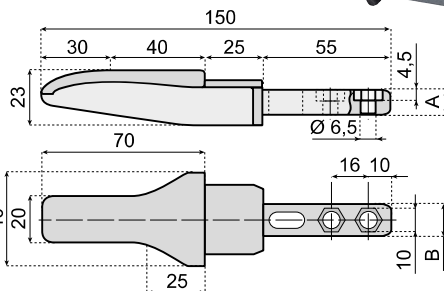

TYPE B

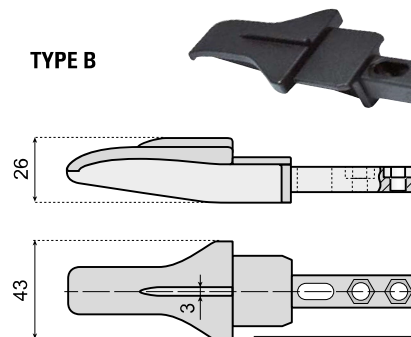

TYPE A for chain L=82.5 mm at pitch 85mm
TYPE B for chain L=82.5 mm at pitch 88mm

APPLICATION: shoes are used to help chain guide between idler wheels and wear strip and must be fixed with M6 screws.



FOR PROFILE	FOR SCREWS	A	B	PA BLACK		
				ITEM DESCRIPTION	ITEM DESCRIPTION	
	M6	16	17	CSHOE-S330	CSHOE-S330T	50
	M6	11	13,5	CSHOE-A330	-	

◀ back continue ▶

Chains & sprockets	Wear strips	Side guide brackets & accessories	Levelers	Engineering manual
Modular belts & sprockets	Chain & belt return systems	Frame & structure supports	Bearing supports	
Curves & tracks	Side guide solutions	Miscellaneous products	Equipment	

50600b

CHAIN INFEEED SHOE LATERAL VERSION FOR STEEL PROFILE

www.SystemPlastSmartGuide.com

For loose profiles, go to: **50580a**

◀ back continue ▶



APPLICATION: shoes are used to help chain guide between idler wheels and wear strip and must be fixed with M5 screws.

Information about this product is only available on our Smart Guide® website.



See other chains infeed:

50600a

LEFT VERSION

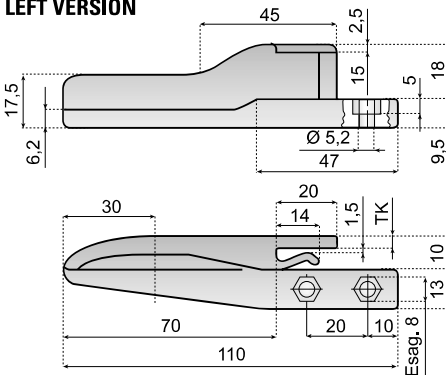

RIGHT VERSION

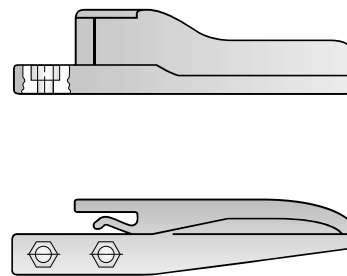

FOR PROFILE	FOR SCREWS	TK mm	LEFT VERSION	RIGHT VERSION	50
			PA BLACK	PA BLACK	
		M5	3	LSHOE-S330	RSHOE-S330

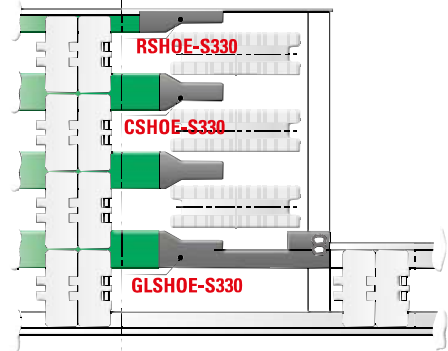
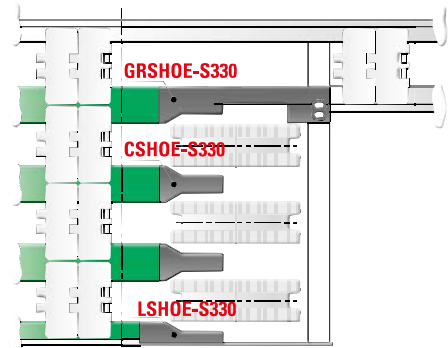

CHAIN INFEEED SHOE TRANSFER VERSION

APPLICATION: shoes are used to help chain guide between idler wheels and wear strip and must be fixed with M6 screws.

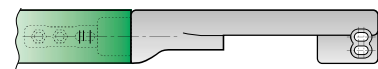
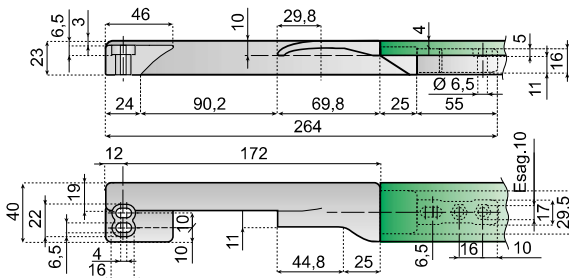

SIDE TRANSFER GUIDE SHOE - LEFT VERSION

FOR PROFILE	PA BLACK	FOR SCREWS	10
		M6	GLSHOE-S330

SIDE TRANSFER GUIDE SHOE - RIGHT VERSION

FOR PROFILE	PA BLACK	FOR SCREWS	10
		M6	GRSHOE-S330

◀ back continue ▶

Chains & sprockets	Wear strips	Side guide brackets & accessories	Levelers	Engineering manual
Modular belts & sprockets	Chain & belt return systems	Frame & structure supports	Bearing supports	
Curves & tracks	Side guide solutions	Miscellaneous products	Equipment	

50610a

WEAR STRIPS

www.SystemPlastSmartGuide.com



◀ back

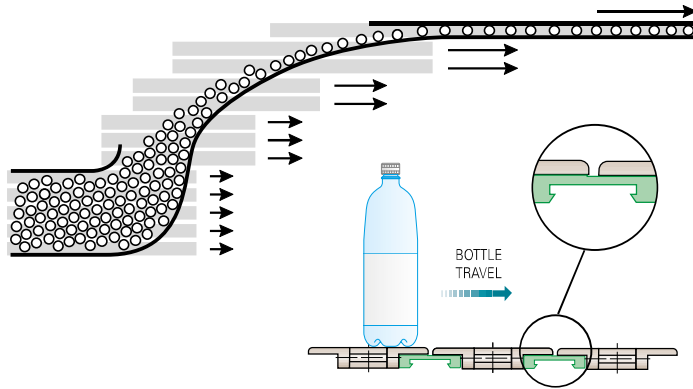

Staggered wear strips are ideal for pressureless combiners. By using these wear strips you can be sure that the product moves freely across the chains. During installation the correct orientation of the profiles has to be respected.

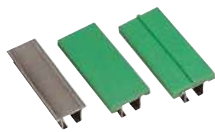

	NOLU-S™ WEAR STRIPS		
	ITEM DESCRIPTION	L	W
	VG-P330CWSM-NS-10	3 m	30 m
	VG-P330CWSM-NS-20	6 m	30 m

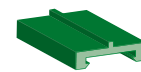

See other wear strips:

50580a



See chains infeed:

50600a

MATERIAL:

Extruded ultra high molecular weight polyethylene.
Max. continuous service temperature in air 90° C.
Water absorption coefficient = 0.

NOTES: this profile can be used in combination with steel profiles S330 and aluminum profiles A330

CHAIN GUIDE WEAR STRIPS

ASSEMBLY	THERMAL EXPANSION	FIXING	SIDE GUIDE
<p>Notes: Steel profile and wear strip can be assembled by using a rubber hammer.</p>	<p>Notes: -Coefficient of linear expansion of wear strip between + 20° C and + 120° C = 0.2 mm/m °C. -Max. continuous service temperature in air: 90° C. -Water absorption = 0.</p>	<p>Notes: rapid wear strip assembly with fixing clamps and connecting elements. See following pages for Item Descriptions.</p>	<p>Application: these profiles can also be used as a side guide.</p>

◀ back

Chains & sprockets	Wear strips	Side guide brackets & accessories	Levelers	Engineering manual
Modular belts & sprockets	Chain & belt return systems	Frame & structure supports	Bearing supports	
Curves & tracks	Side guide solutions	Miscellaneous products	Equipment	

50650a

BAR CAPS

www.SystemPlastSmartGuide.com

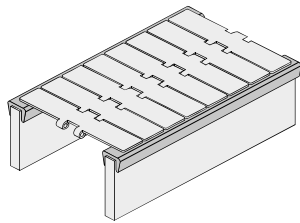

MATERIAL:

Extruded ultra high molecular weight polyethylene.
 ** Extruded high molecular weight polyethylene.
 Max. continuous service temperature in air 90° C.
 Water absorption coefficient = 0.

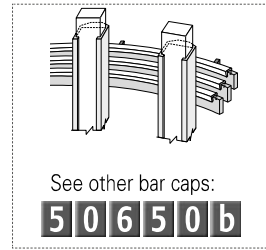

See other bar caps:

50650b



	NOLU-SR™ DARK GREY	NOLU-S™ BAR CAPS	** HMWPE WHITE	UHMWPE WHITE			
	ITEM DESCRIPTION						
	VG-P105RCL-100	VG-P105R-100	-	-	30 m	-	30 m
	VG-P105RCL-250	VG-P105R-250	-	-	75 m	-	75 m
	-	VG-P18BC-NS-100	-	VG-P18BC-100	30 m	-	30 m
	-	VG-PM4BC-NS-100	-	VG-PM4BC-100	30 m	-	30 m
	-	-	-	VG-PM4BC-250	75 m	-	75 m
	-	-	-	VG-P316BC-100	30 m	-	30 m
	-	-	-	VG-P7GABC-100	30 m	-	30 m
	VG-P58MR-NSR-100	-	VG-P58MR-W-100	VG-P58MR-100	30 m	-	30 m

Chains & sprockets	Wear strips	Side guide brackets & accessories	Levelers	Engineering manual
Modular belts & sprockets	Chain & belt return systems	Frame & structure supports	Bearing supports	
Curves & tracks	Side guide solutions	Miscellaneous products	Equipment	

50650b

BAR CAPS

www.SystemPlastSmartGuide.com

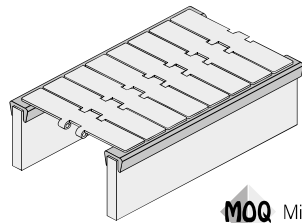

MOQ Min. order quantity: 252 m

MATERIAL:

Extruded ultra high molecular weight polyethylene.
 ** Extruded high molecular weight polyethylene.
 Max. continuous service temperature in air 90° C.
 Water absorption coefficient = 0.



		NOLU-S™ BAR CAP	** HMWPE WHITE	New UHMWPE WHITE			
		ITEM DESCRIPTION					
		VG-P14BC-NS-100	-	VG-P14BC-100	30 m	-	30 m
		VG-P516BC-NS-100	-	VG-P516BC-100	30 m	-	30 m
		VG-PM10BC-NS-250	-	VG-PM10BC-250	75 m	-	75 m
		VG-P7GAHD-NS-20	-	VG-P7GAHD-20		6 m	60 m
		-	-	VG-P18HD-20	-	6 m	60 m
		-	-	VG-P316HD-20	-	6 m	60 m
		-	-	VG-P14HD-20	-	6 m	60 m
		-	VG-P1x1BC-W-20	-	6 m	-	6 m

Chains & sprockets	Wear strips	Side guide brackets & accessories	Levelers	Engineering manual
Modular belts & sprockets	Chain & belt return systems	Frame & structure supports	Bearing supports	
Curves & tracks	Side guide solutions	Miscellaneous products	Equipment	

5 0 6 5 0 z

APPLICATION EXAMPLES

www.SystemPlastSmartGuide.com



CHAIN & BELT SUPPORT SYSTEM.

For details, go to:

5 0 5 8 0 a



BAR CAP PROFILES FOR SPIRAL CONVEYOR SYSTEMS.

For details, go to:











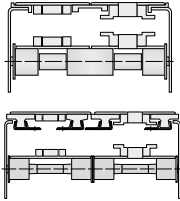

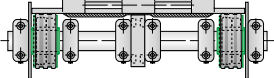

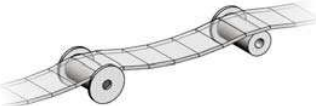

5 0 5 6 0 a

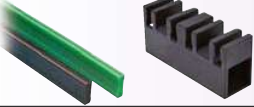
Chains & sprockets	Wear strips	Side guide brackets & accessories	Levelers	Engineering manual
Modular belts & sprockets	Chain & belt return systems	Frame & structure supports	Bearing supports	
Curves & tracks	Side guide solutions	Miscellaneous products	Equipment	

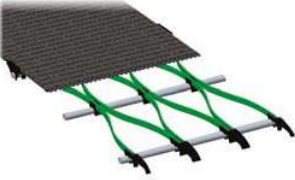
5 1 0 1 0 a

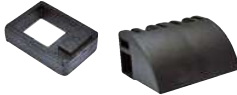
INDEX CHAIN & BELT ROLLERS SYSTEMS

www.SystemPlastSmartGuide.com

		Chain return rollers 85 mm center distance	5 1 0 2 0 a BLACK COLOR  5 1 0 6 0 a GREEN COLOR
		Chain return rollers Other center distances	5 1 0 3 0 a
		Watertight return rollers 27mm versions	5 1 0 4 0 a
		Watertight return rollers 40/43mm versions	5 1 0 5 0 a
	 	Watertight return rollers 82/85mm versions	5 1 0 8 0 a STANDARD  5 1 1 1 0 a SOLID VERSION
		Flanges for Return Rollers	5 1 0 9 0 a
	 	Wear strip & Clamps for serpentine system	5 1 1 2 0 a
		Little striker & Striker for serpentine system	5 1 1 3 0 a
	 	Single spacer & Shoe wear strip for serpentine system	5 1 1 5 0 a
		Washer & Sliding shoe for serpentine system	 5 1 1 6 0 a
		Wearshoes for return system	5 1 1 7 0 a



Information about this product is only available on our Smart Guide® website.

Chains & sprockets	Wear strips	Side guide brackets & accessories	Levelers	Engineering manual
Modular belts & sprockets	Chain & belt return systems	Frame & structure supports	Bearing supports	
Curves & tracks	Side guide solutions	Miscellaneous products	Equipment	

51020a

CHAIN RETURN ROLLERS

www.SystemPlastSmartGuide.com

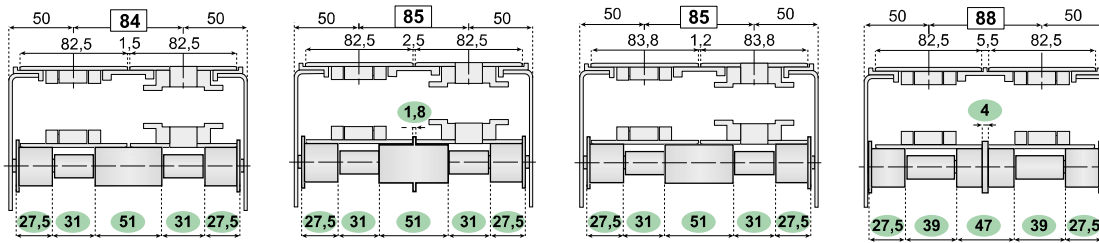

SPACER (LENGTH 31 mm)

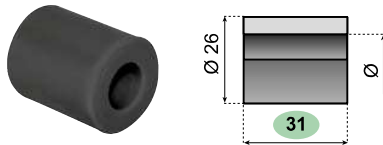

MATERIAL	FOR ROD				
	Ø 12	Ø 16	Ø 18	Ø 20	
ITEM DESCRIPTION					
PA BLACK	R-26B12ML31-PAB	R-26B16ML31-PAB	R-26B18ML31-PAB	R-26B20ML31-PAB	100

External diameter



SPACER (LENGTH 39 mm)

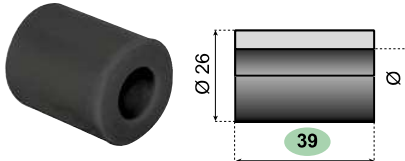

MATERIAL	FOR ROD				
	Ø 12	Ø 16	Ø 18	Ø 20	
ITEM DESCRIPTION					
PA BLACK	R-26B12ML39-PAB	R-26B16ML39-PAB	R-26B18ML39-PAB	R-26B20ML39-PAB	100

External diameter



RETURN ROLLER WITH FLANGE

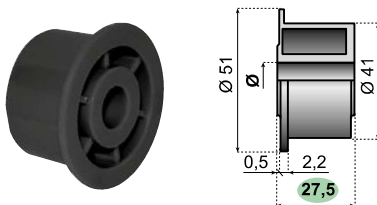

MATERIAL	FOR ROD				
	Ø 12	Ø 16	Ø 18	Ø 20	
ITEM DESCRIPTION					
PE-HD BLACK	RF-41B12ML28-PEB	RF-41B16ML28-PEB	RF-41B18ML28-PEB	RF-41B20ML28-PEB	100

External diameter



RETURN ROLLER

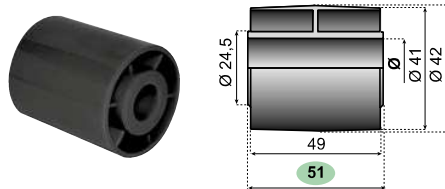

MATERIAL	FOR ROD				
	Ø 12	Ø 16	Ø 18	Ø 20	
ITEM DESCRIPTION					
PE-HD BLACK	R-41B12ML51-PEB	R-41B16ML51-PEB	R-41B18ML51-PEB	R-41B20ML51-PEB	100

External diameter



RETURN ROLLER WITH CENTER FLANGE

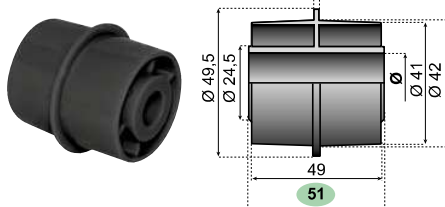

MATERIAL	FOR ROD				
	Ø 12	Ø 16	Ø 18	Ø 20	
ITEM DESCRIPTION					
PE-HD BLACK	RF-41B12ML51-PEB	RF-41B16ML51-PEB	RF-41B18ML51-PEB	RF-41B20ML51-PEB	100

External diameter



RETURN ROLLER WITH CENTER FLANGE

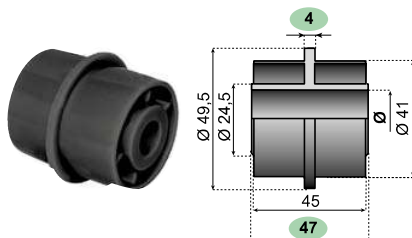

MATERIAL	FOR ROD				
	Ø 12	Ø 16	Ø 18	Ø 20	
ITEM DESCRIPTION					
PE-HD BLACK	RF-41B12ML47-PEB	RF-41B16ML47-PEB	RF-41B18ML47-PEB	RF-41B20ML47-PEB	100

External diameter



Also available in green color. Go to: **51060a**



Information about this product is only available on our Smart Guide® website.

Chains & sprockets	Wear strips	Side guide brackets & accessories	Levelers	Engineering manual
Modular belts & sprockets	Chain & belt return systems	Frame & structure supports	Bearing supports	
Curves & tracks	Side guide solutions	Miscellaneous products	Equipment	



5 1 0 3 0 a

CHAIN RETURN ROLLERS

www.SystemPlastSmartGuide.com

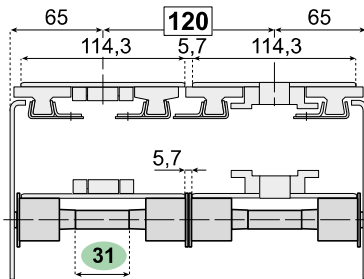
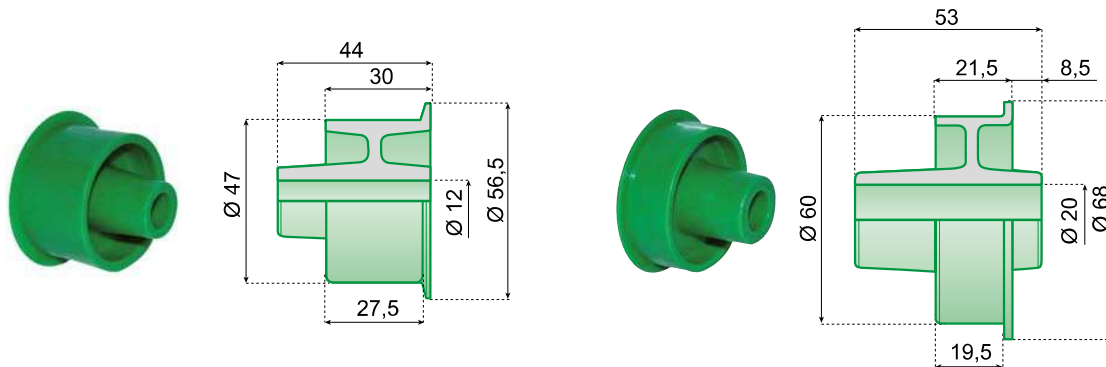

Go to: **5 1 0 2 0 a**

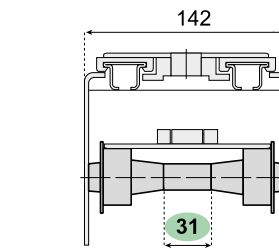

Go to: **5 1 0 2 0 a**

RETURN ROLLER WITH FLANGE

Ø 47 External diameter	SHAFT Ø12	
MATERIAL	ITEM DESCRIPTION	
PE-HD GREEN	RF-47B12ML44-PEG	100

RETURN ROLLER WITH FLANGE

Ø 60 External diameter	FOR ROD Ø 20	
MATERIAL	ITEM DESCRIPTION	
PE-HD GREEN	RF-60B20ML53-PEG	100

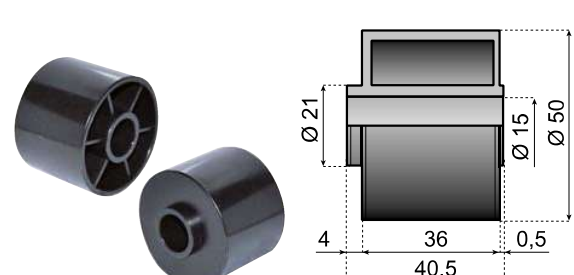
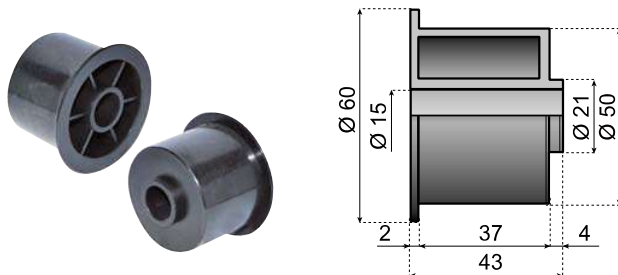

RETURN ROLLER WITH FLANGE

Ø 50 External diameter	FOR ROD Ø 15	
MATERIAL	ITEM DESCRIPTION	
PE-HD BLACK	RF-50B15ML43-PEB	100

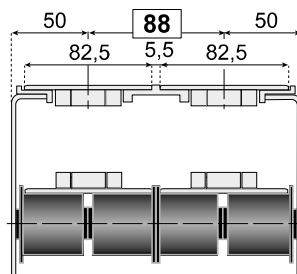

RETURN ROLLER

Ø 50 External diameter	FOR ROD Ø 15	
MATERIAL	ITEM DESCRIPTION	
PE-HD BLACK	RF-50B15ML41-PEB	100

Chains & sprockets	Wear strips	Side guide brackets & accessories	Levelers	Engineering manual
Modular belts & sprockets	Chain & belt return systems	Frame & structure supports	Bearing supports	
Curves & tracks	Side guide solutions	Miscellaneous products	Equipment	

51040a

ROLLERS FOR RETURN OF CHAINS & BELTS

www.SystemPlastSmartGuide.com



External diameter

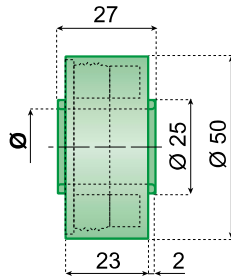

CHARACTERISTICS:

- Very low friction coefficient.
- No liquid absorption.
- Excellent wear and chemical resistance.
- Completely closed structure, easier to clean and disinfect.
- Watertight.

WATERTIGHT ROLLER

MATERIAL	FOR ROD			
	Ø 16	Ø 18	Ø 20	
ITEM DESCRIPTION				
PE-HD GREEN	R-50B16ML27-PEG	R-50B18ML27-PEG	R-50B20ML27-PEG	100
VERSION WITH FLANGE				
PE-HD GREEN	RF-50B16ML28-PEG	RF-50B18ML28-PEG	RF-50B20ML28-PEG	100



VERSION WITH FLANGE

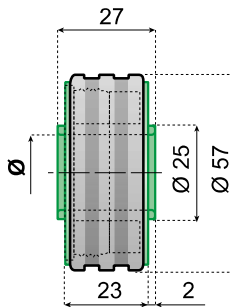
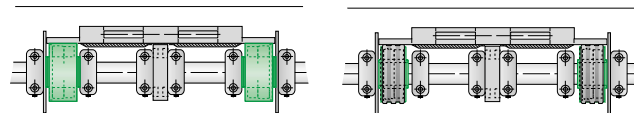
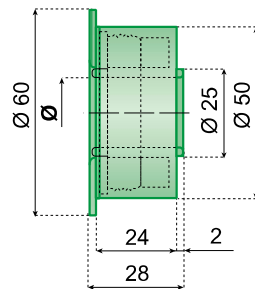

WATERTIGHT ROLLER WITH RUBBER

MATERIAL	FOR ROD			
	Ø 16	Ø 18	Ø 20	
ITEM DESCRIPTION				
PE-HD GREEN	RR-57B16ML27-PEG	RR-57B18ML27-PEG	RR-57B20ML27-PEG	100
VERSION WITH FLANGE				
PE-HD GREEN	RRF-57B16ML28-PEG	RRF-57B18ML28-PEG	RRF-57B20ML28-PEG	100



External diameter



VERSION WITH FLANGE

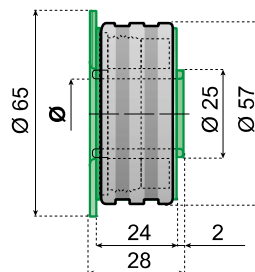

RUBBER MATERIAL: TPR

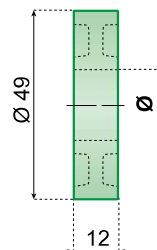

ROLLER

MATERIAL	FOR ROD			
	Ø 16	Ø 18	Ø 20	
ITEM DESCRIPTION				
PP GREEN	R-49B16ML12-PPG	R-49B18ML12-PPG	R-49B20ML12-PPG	100

Chains & sprockets	Wear strips	Side guide brackets & accessories	Levelers	Engineering manual
Modular belts & sprockets	Chain & belt return systems	Frame & structure supports	Bearing supports	
Curves & tracks	Side guide solutions	Miscellaneous products	Equipment	

51050a

ROLLERS FOR RETURN OF CHAINS & BELTS

www.SystemPlastSmartGuide.com



External diameter

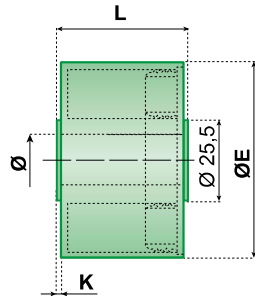

VERSION WITH FLANGE

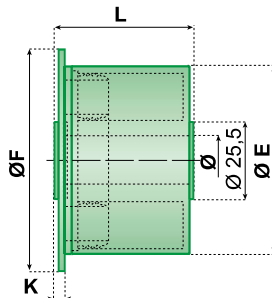

CHARACTERISTICS:

- Very low friction coefficient.
- No liquid absorption.
- Excellent wear and chemical resistance.
- Completely closed structure, easier to clean and disinfect.
- Watertight.

WATERTIGHT ROLLER

MATERIAL	ØE	ØF	L	K	FOR ROD			
					Ø 16	Ø 18	Ø 20	
					ITEM DESCRIPTION			
PE-HD GREEN	50	-	40,5	1,5	R-50B16ML41-PEG	R-50B18ML41-PEG	R-50B20ML41-PEG	100
		-	43	4	R-50B16ML43-PEG	R-50B18ML43-PEG	R-50B20ML43-PEG	
	60	-	40,5	1,5	R-60B16ML41-PEG	R-60B18ML41-PEG	R-60B20ML41-PEG	
VERSION WITH FLANGE								
PE-HD GREEN	50	65	43	4	RF-50B16ML43-PEG	RF-50B18ML43-PEG	RF-50B20ML43-PEG	100
	60	75			RF-60B16ML43-PEG	RF-60B18ML43-PEG	RF-60B20ML43-PEG	

CHARACTERISTICS:

- Reduced noise level with rubber
- Very low friction coefficient.
- No liquid absorption.
- Excellent wear and chemical resistance.
- Completely closed structure, easier to clean and disinfect.
- Watertight.

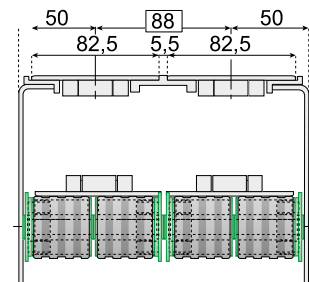
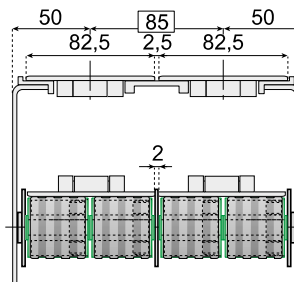
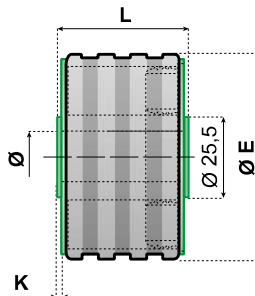

External diameter

WATERTIGHT ROLLER WITH RUBBER

MATERIAL	ØE	ØF	L	K	FOR ROD			
					Ø 16	Ø 18	Ø 20	
					ITEM DESCRIPTION			
PE-HD GREEN	57	-	40,5	1,5	RR-57B16ML41-PEG	RR-57B18ML41-PEG	RR-57B20ML41-PEG	100
		-	43	4	RR-57B16ML43-PEG	RR-57B18ML43-PEG	RR-57B20ML43-PEG	
	67	-	40,5	1,5	RR-67B16ML41-PEG	RR-67B18ML41-PEG	RR-67B20ML41-PEG	
VERSION WITH FLANGE								
PE-HD GREEN	57	65	43	4	RRF-57B16ML43-PEG	RRF-57B18ML43-PEG	RRF-57B20ML43-PEG	100

RUBBER MATERIAL: TPR

Rollers with Diam. 67mm also available in black color. Min. order quantity: 300 pcs.

VERSION WITH FLANGE

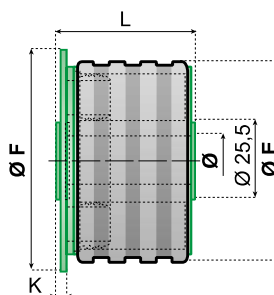

Chains & sprockets	Wear strips	Side guide brackets & accessories	Levelers	Engineering manual
Modular belts & sprockets	Chain & belt return systems	Frame & structure supports	Bearing supports	
Curves & tracks	Side guide solutions	Miscellaneous products	Equipment	

5 1 0 6 0 a

CHAIN RETURN ROLLERS

www.SystemPlastSmartGuide.com

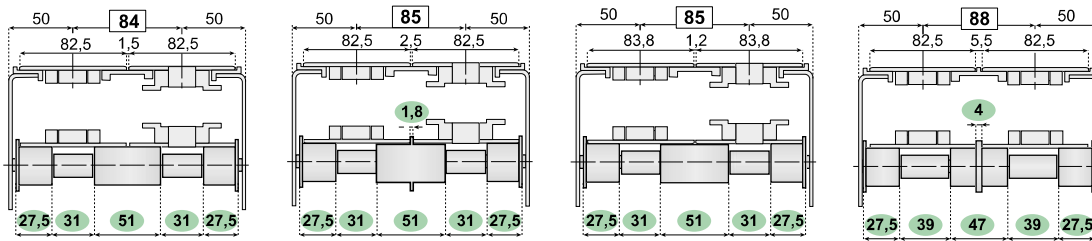

SPACER (LENGTH 31 mm)

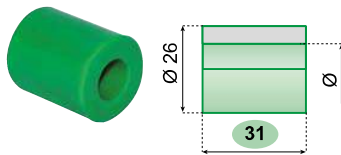

MATERIAL	FOR ROD				
	Ø 12	Ø 16	Ø 18	Ø 20	
ITEM DESCRIPTION					
PA GREEN	R-26B12ML31-PAG ^{MOQ}	R-26B16ML31-PAG ^{MOQ}	R-26B18ML31-PAG ^{MOQ}	R-26B20ML31-PAG ^{MOQ}	100

External diameter

Ø 26

SPACER (LENGTH 39 mm)

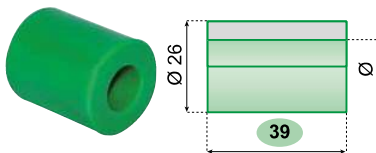

MATERIAL	FOR ROD				
	Ø 12	Ø 16	Ø 18	Ø 20	
ITEM DESCRIPTION					
PA GREEN	R-26B12ML39-PAG ^{MOQ}	R-26B16ML39-PAG ^{MOQ}	R-26B18ML39-PAG ^{MOQ}	R-26B20ML39-PAG ^{MOQ}	100

External diameter

Ø 26

RETURN ROLLER WITH FLANGE

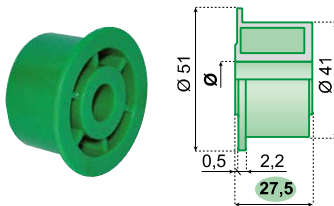

MATERIAL	FOR ROD				
	Ø 12	Ø 16	Ø 18	Ø 20	
ITEM DESCRIPTION					
PE-HD GREEN	RF-41B12ML28-PEG ^{MOQ}	RF-41B16ML28-PEG ^{MOQ}	RF-41B18ML28-PEG ^{MOQ}	RF-41B20ML28-PEG ^{MOQ}	100

External diameter

Ø 41

RETURN ROLLER

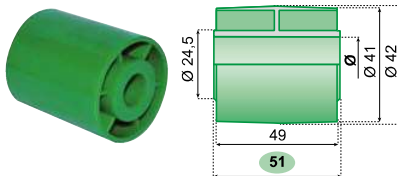

MATERIAL	FOR ROD				
	Ø 12	Ø 16	Ø 18	Ø 20	
ITEM DESCRIPTION					
PE-HD GREEN	R-41B12ML51-PEG ^{MOQ}	R-41B16ML51-PEG ^{MOQ}	R-41B18ML51-PEG ^{MOQ}	R-41B20ML51-PEG ^{MOQ}	100

External diameter

Ø 42

RETURN ROLLER WITH CENTER FLANGE

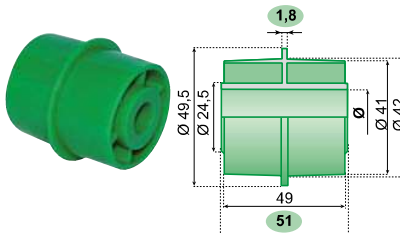

MATERIAL	FOR ROD				
	Ø 12	Ø 16	Ø 18	Ø 20	
ITEM DESCRIPTION					
PE-HD GREEN	RF-41B12ML51-PEG ^{MOQ}	-	RF-41B18ML51-PEG ^{MOQ}	RF-41B20ML51-PEG ^{MOQ}	100

External diameter

Ø 42

RETURN ROLLER WITH CENTER FLANGE

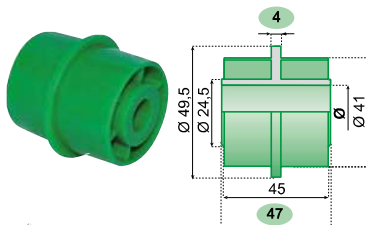

MATERIAL	FOR ROD				
	Ø 12	Ø 16	Ø 18	Ø 20	
ITEM DESCRIPTION					
PE-HD GREEN	RF-41B12ML47-PEG ^{MOQ}	RF-41B16ML47-PEG ^{MOQ}	RF-41B18ML47-PEG ^{MOQ}	-	100

External diameter

Ø 41

MOQ Min. order quantity: 500 pcs.

Information about this product is only available on our Smart Guide® website.

Also available in black color. Go to: **5 1 0 2 0 a**

Chains & sprockets	Wear strips	Side guide brackets & accessories	Levelers	Engineering manual
Modular belts & sprockets	Chain & belt return systems	Frame & structure supports	Bearing supports	
Curves & tracks	Side guide solutions	Miscellaneous products	Equipment	

51080a

RETURN ROLLERS POLYETHYLENE

www.SystemPlastSmartGuide.com

CHARACTERISTICS:

- Very low friction coefficient
- No liquid absorption
- Excellent wear and chemical resistance
- Completely closed structure, easier to clean and disinfect
- Watertight

Also available with improved chemical resistance, go to:

51110a



Information about this product is only available on our Smart Guide® website.

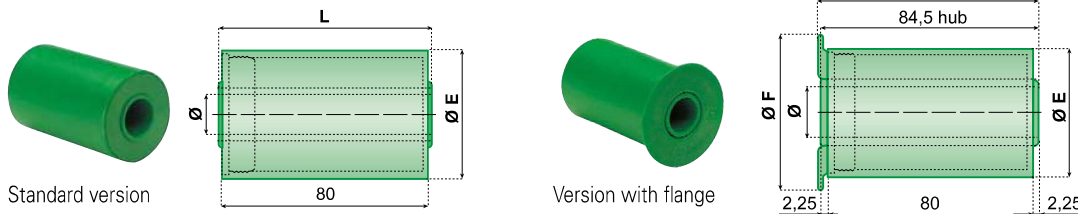

WATERTIGHT ROLLER

MATERIAL	Ø E	L	F	FOR ROD					
				Ø 12	Ø 14	Ø 16	Ø 18	Ø 20	
ITEM DESCRIPTION									
STANDARD VERSION									
PE-HD GREEN	40	82,5	-	-	-	R-40B16ML83-PEG	R-40B18ML83-PEG	R-40B20ML83-PEG	50
		84,5	-	-	-	R-40B16ML85-PEG	R-40B18ML85-PEG	R-40B20ML85-PEG	
	50	82,5	-	-	-	R-50B16ML83-PEG	R-50B18ML83-PEG	R-50B20ML83-PEG	
		84,5	-	-	-	R-50B16ML85-PEG	R-50B18ML85-PEG	R-50B20ML85-PEG	
	60	82,5	-	-	-	R-60B16ML83-PEG	R-60B18ML83-PEG	R-60B20ML83-PEG	
		84,5	-	R-60B12ML85-PEG	R-60B14ML85-PEG	R-60B16ML85-PEG	R-60B18ML85-PEG	R-60B20ML85-PEG	
VERSION WITH FLANGE									
PE-HD GREEN	40	85,8	55	-	-	RF-40B16ML86-PEG	RF-40B18ML86-PEG	RF-40B20ML86-PEG	50
	50	85,8	65	-	-	RF-50B16ML86-PEG	RF-50B18ML86-PEG	RF-50B20ML86-PEG	
	60	85,8	65	RF-60B12ML86-PEG	RF-60B14ML86-PEG	RF-60B16ML86-PEG	RF-60B18ML86-PEG	RF-60B20ML86-PEG	



External diameter

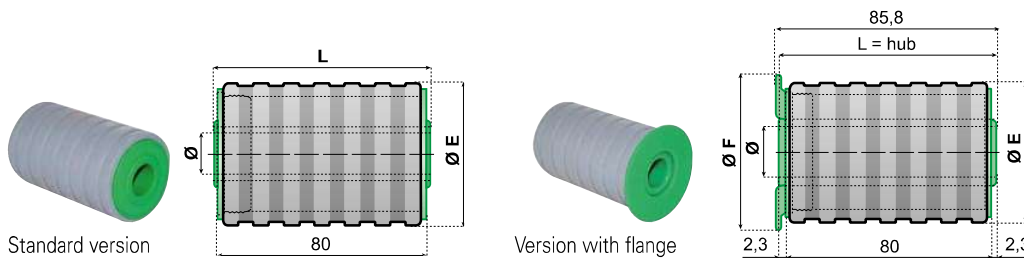

WATERTIGHT ROLLER WITH RUBBER

MATERIAL	Ø E	L	F	FOR ROD			
				Ø 16	Ø 18	Ø 20	
ITEM DESCRIPTION							
STANDARD VERSION							
PE-HD GREEN	47	82,5	-	RR-47B16ML83-PEG	RR-47B18ML83-PEG	RR-47B20ML83-PEG	50
		84,5	-	RR-47B16ML85-PEG	RR-47B18ML85-PEG	RR-47B20ML85-PEG	
	57	82,5	-	RR-57B16ML83-PEG	RR-57B18ML83-PEG	RR-57B20ML83-PEG	
		84,5	-	RR-57B16ML85-PEG	RR-57B18ML85-PEG	RR-57B20ML85-PEG	
	67	82,5	-	RR-67B16ML83-PEG	RR-67B18ML83-PEG	RR-67B20ML83-PEG	
		84,5	-	RR-67B16ML85-PEG	RR-67B18ML85-PEG	RR-67B20ML85-PEG	
VERSION WITH FLANGE							
PE-HD GREEN	47	85,8	55	RRF-40B16ML86-PEG	RRF-40B18ML86-PEG	RRF-40B20ML86-PEG	50
	57	85,8	65	RRF-50B16ML86-PEG	RRF-50B18ML86-PEG	RRF-50B20ML86-PEG	
	67	85,8	75	RRF-60B16ML86-PEG	RRF-60B18ML86-PEG	RRF-60B20ML86-PEG	



External diameter

CHARACTERISTICS:

- Reduced noise level
- Very low friction coefficient
- No liquid absorption
- Excellent wear and chemical resistance
- Completely closed structure, easier to clean and disinfect
- Watertight

RUBBER MATERIAL: TPR

Chains & sprockets	Wear strips	Side guide brackets & accessories	Levelers	Engineering manual
Modular belts & sprockets	Chain & belt return systems	Frame & structure supports	Bearing supports	
Curves & tracks	Side guide solutions	Miscellaneous products	Equipment	

5 1 0 9 0 a

FLANGES FOR RETURN ROLLERS

www.SystemPlastSmartGuide.com



GUIDE FLANGE

CHARACTERISTICS:

- No liquid absorption.
- Excellent wear and chemical resistance.

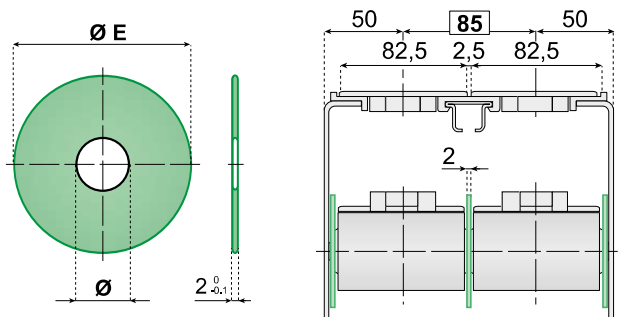

GUIDE FLANGE

MATERIAL	Ø E	FOR PIN				
		Ø 14	Ø 16	Ø 18	Ø 20	
ITEM DESCRIPTION						
PP GREEN	50	F-50B14ML2-PPG ¹⁰⁰	F-50B16ML2-PPG ¹⁰⁰	F-50B18ML2-PPG	F-50B20ML2-PPG	100
	60	F-60B14ML2-PPG ¹⁰⁰	F-60B16ML2-PPG ¹⁰⁰	F-60B18ML2-PPG	F-60B20ML2-PPG	
	70	F-70B14ML2-PPG	F-70B16ML2-PPG	F-70B18ML2-PPG	F-70B20ML2-PPG	
	75	F-75B14ML2-PPG	-	F-75B18ML2-PPG	F-75B20ML2-PPG	
	100	-	-	F-100B18ML2-PPG	F-100B20ML2-PPG	

MOQ Min. order quantity: 250 pcs.

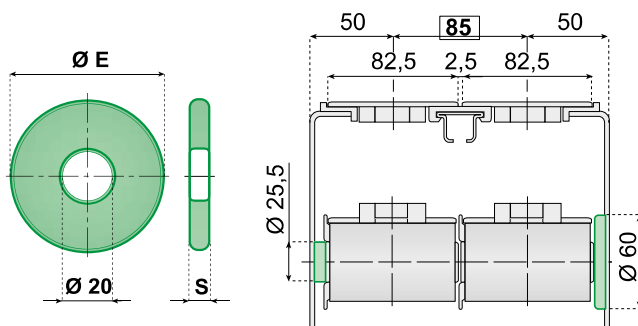

GUIDE FLANGE

MATERIAL	Ø E	S	FOR PIN	
			Ø 20	
ITEM DESCRIPTION				
PP GREEN	25,5	7,25	F-26B20ML7-PPG	100
	60	7,25	F-60B20ML7-PPG	
	90	5	F-90B20ML5-PPG	

Chains & sprockets	Wear strips	Side guide brackets & accessories	Levelers	Engineering manual
Modular belts & sprockets	Chain & belt return systems	Frame & structure supports	Bearing supports	
Curves & tracks	Side guide solutions	Miscellaneous products	Equipment	

51110a

SOLID ROLLERS FOR CHAINS AND BELTS

www.SystemPlastSmartGuide.com

Also available in PE Material, watertight version, go to:

51080a

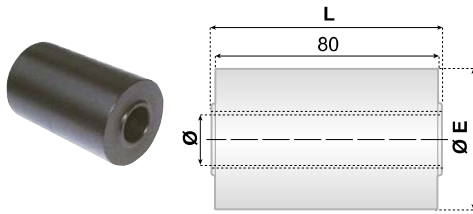

WATERTIGHT ROLLER

CHARACTERISTICS:

- Very low friction coefficient.
- No liquid absorption.
- Excellent wear and chemical resistance.
- Completely closed structure.
- Watertight.

WATERTIGHT ROLLER

MATERIAL	Ø E	L	FOR ROD				ITEM DESCRIPTION	Image icon
			Ø 15	Ø 16	Ø 18	Ø 20		
PE BLACK	40	82,5	R-40B15ML83-PEB-S	R-40B16ML83-PEB-S	R-40B18ML83-PEB-S	R-40B20ML83-PEB-S	50	Image icon
		84,5	R-40B15ML85-PEB-S	R-40B16ML85-PEB-S	R-40B18ML85-PEB-S	R-40B20ML85-PEB-S		
	50	82,5	R-50B15ML83-PEB-S	R-50B16ML83-PEB-S	R-50B18ML83-PEB-S	R-50B20ML83-PEB-S		
		84,5	R-50B15ML85-PEB-S	R-50B16ML85-PEB-S	R-50B18ML85-PEB-S	R-50B20ML85-PEB-S		
	60	82,5	R-60B15ML83-PEB-S	R-60B16ML83-PEB-S	R-60B18ML83-PEB-S	R-60B20ML83-PEB-S		
		84,5	R-60B15ML85-PEB-S	R-60B16ML85-PEB-S	R-60B18ML85-PEB-S	R-60B20ML85-PEB-S		



External diameter

MOQ Min. order quantity: 100 pcs.

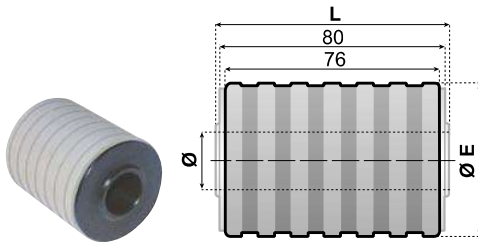

WATERTIGHT ROLLER WITH RUBBER

MATERIAL	Ø E	L	FOR ROD				ITEM DESCRIPTION	Image icon
			Ø 15	Ø 16	Ø 18	Ø 20		
PE BLACK	47	82,5	RR-47B15ML83-PEB-S	RR-47B16ML83-PEB-S	RR-47B18ML83-PEB-S	RR-47B20ML83-PEB-S	50	Image icon
		84,5	RR-47B15ML85-PEB-S	RR-47B16ML85-PEB-S	RR-47B18ML85-PEB-S	RR-47B20ML85-PEB-S		
	57	82,5	RR-57B15ML83-PEB-S	RR-57B16ML83-PEB-S	RR-57B18ML83-PEB-S	RR-57B20ML83-PEB-S		
		84,5	RR-57B15ML85-PEB-S	RR-57B16ML85-PEB-S	RR-57B18ML85-PEB-S	RR-57B20ML85-PEB-S		
	67	82,5	RR-67B15ML83-PEB-S	RR-67B16ML83-PEB-S	RR-67B18ML83-PEB-S	RR-67B20ML83-PEB-S		
		84,5	RR-67B15ML85-PEB-S	RR-67B16ML85-PEB-S	RR-67B18ML85-PEB-S	RR-67B20ML85-PEB-S		



External diameter

RUBBER MATERIAL: TPR

MOQ Min. order quantity: 100 pcs.

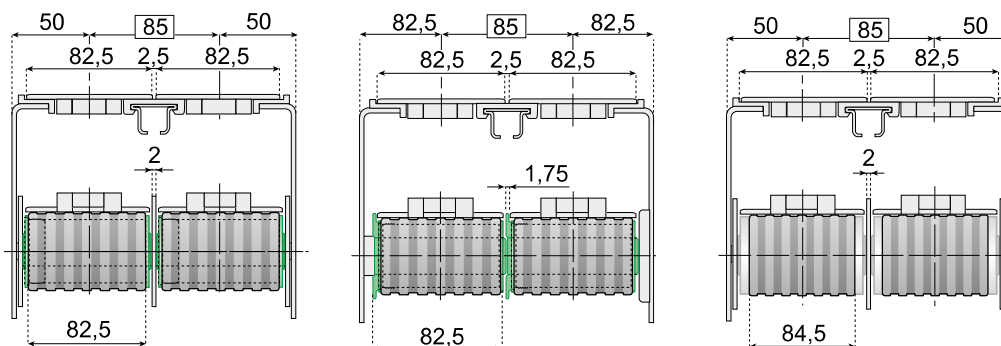

For flanges for return rollers, go to:

51090a

Chains & sprockets	Wear strips	Side guide brackets & accessories	Levelers	Engineering manual
Modular belts & sprockets	Chain & belt return systems	Frame & structure supports	Bearing supports	
Curves & tracks	Side guide solutions	Miscellaneous products	Equipment	

SYSTEM PLAST®



5 1 1 2 0 a

CHAIN RETURN COMPONENTS

www.SystemPlastSmartGuide.com



Information about this product is only available on our Smart Guide® website.

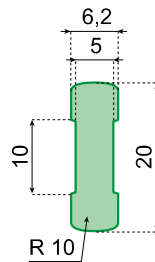
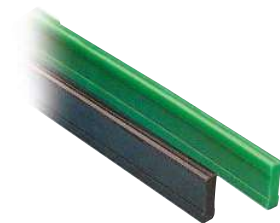
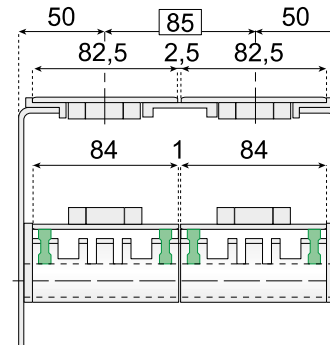
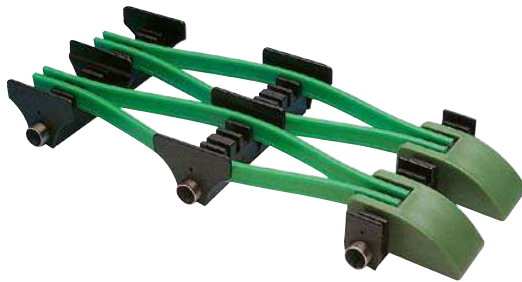

WEAR STRIP

MATERIAL	ITEM DESCRIPTION		
PE GREEN	VG-F206M-G-200	60 m	60 m
PE BLACK	VG-F206M-B-200	60 m	60 m
Nolu®-S	VG-F206M-NS-200	60 m	60 m

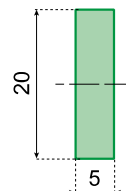
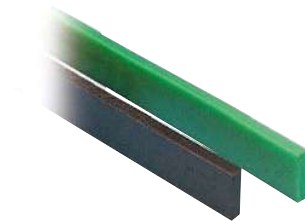

WEAR STRIP

MATERIAL	ITEM DESCRIPTION		
PE GREEN	VG-F205M-G-200	60 m	60 m
PE BLACK	VG-F205M-B-200	60 m	60 m

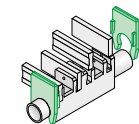

For chains return components, go to:

5 1 1 3 0 a

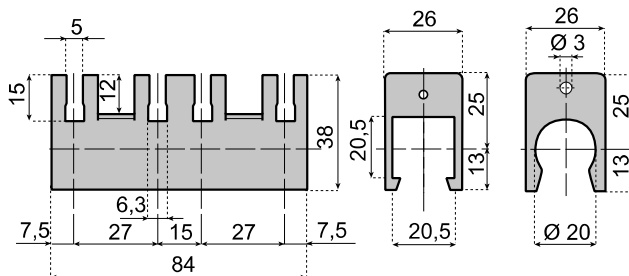

SPACER FOR SERPENTINE

MATERIAL			
	20x20	Ø 20	
ITEM DESCRIPTION			
PA BLACK	SPT-84-S20C	SPT-84-R20C	100

For solutions for 101,6 (4") and 114,3 (4 ½) top plates, go to: **5 1 1 6 0 a**

Chains & sprockets	Wear strips	Side guide brackets & accessories	Levelers	Engineering manual
Modular belts & sprockets	Chain & belt return systems	Frame & structure supports	Bearing supports	
Curves & tracks	Side guide solutions	Miscellaneous products	Equipment	

51130a

CHAIN RETURN COMPONENTS

www.SystemPlastSmartGuide.com

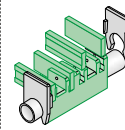

For chain return components, go to:

51120a

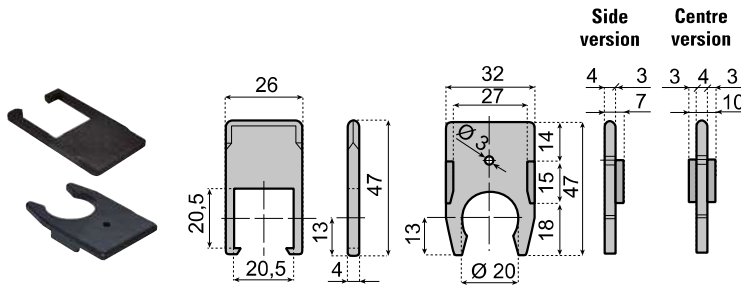

LITTLE WASHER

MATERIAL	20x20	Ø 20	Ø 20	
ITEM DESCRIPTION				
PA BLACK	SPT-4L26-S20C	SPT-4L26S-R20C	SPT-4L26C-R20C	100

APPLICATION EXAMPLE

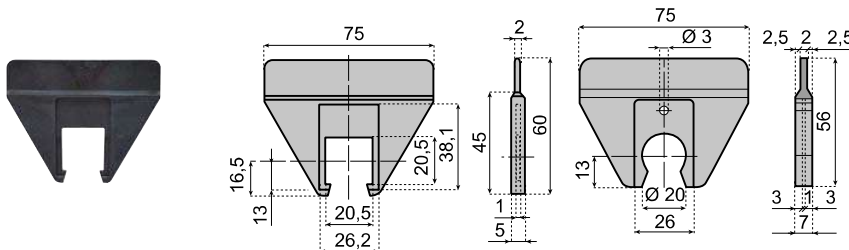
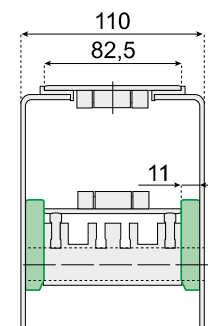
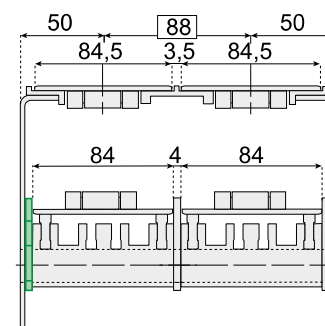
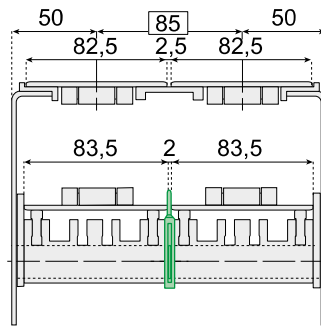
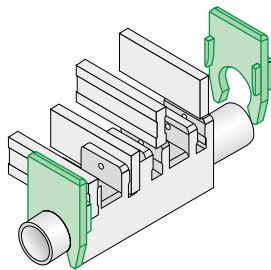

BIG STRIKER

MATERIAL	20x20	Ø 20	
ITEM DESCRIPTION			
PA BLACK	SPT-2L75-S20C	SPT-2L75-R20C	100

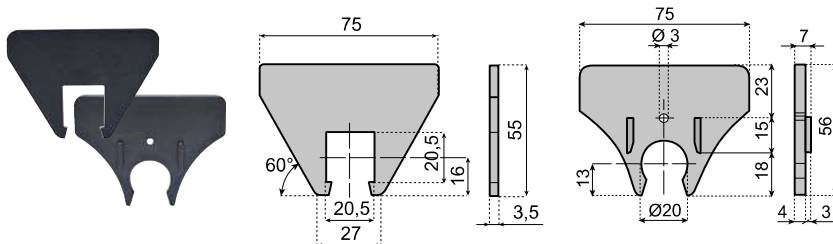

BIG STRIKER

MATERIAL	20x20	Ø 20	
ITEM DESCRIPTION			
PA BLACK	SPT-4L75-S20C	SPT-4L75-R20C	100

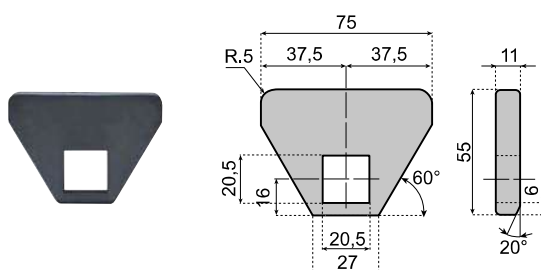

APPLICATION EXAMPLE

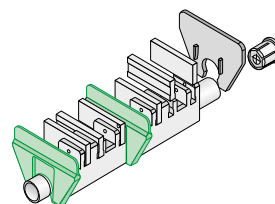

EXTRA STRIKER

MATERIAL	20x20	
ITEM DESCRIPTION		
PA BLACK	SPT-11L75-S20	100

Chains & sprockets	Wear strips	Side guide brackets & accessories	Levelers	Engineering manual
Modular belts & sprockets	Chain & belt return systems	Frame & structure supports	Bearing supports	
Curves & tracks	Side guide solutions	Miscellaneous products	Equipment	



5 1 1 5 0 a

FLEXIBLE WIDTH SERPENTINE SYSTEM

www.SystemPlastSmartGuide.com

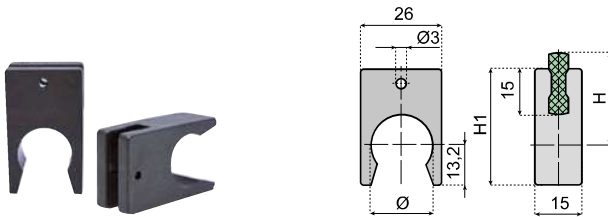

SINGLE SPACER SNAP-ON ASSEMBLY

MATERIAL	Ø 18	Ø 20	H	H1	
	ITEM DESCRIPTION				
PA BLACK	SPT-15R18C	-	34	42.5	100
	-	SPT-15R20C	30	38	

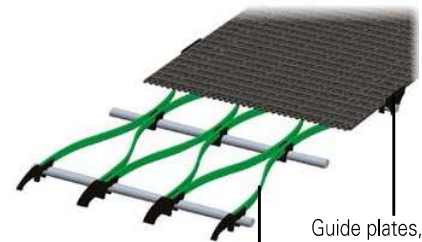

Guide plates, go to:
5 1 1 3 0 a

Profiles, go to:
5 1 1 2 0 a

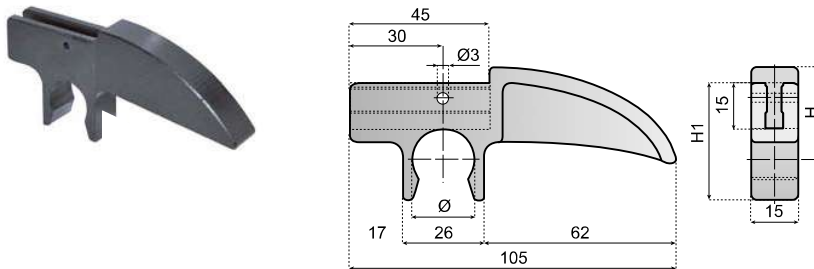

SHOE WEAR STRIP SNAP-ON ASSEMBLY

MATERIAL	Ø 18	Ø 20	H	H1	
	ITEM DESCRIPTION				
PA BLACK	SHOE-15L105-R18C-PAB	-	34	42,5	100
	-	SHOE-15L105-R20C-PAB	30	38	

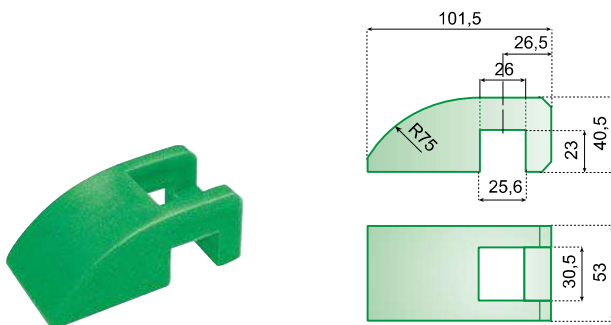

SLIDING SHOE

MATERIAL	ITEM DESCRIPTION	
PE GREEN	SHOE-53L102-S25C-PEG	100

USE: with spacers SPT-84-R20C.



For chain return components, go to:

5 1 1 2 0 a
5 1 1 3 0 a

Chains & sprockets	Wear strips	Side guide brackets & accessories	Levelers	Engineering manual
Modular belts & sprockets	Chain & belt return systems	Frame & structure supports	Bearing supports	
Curves & tracks	Side guide solutions	Miscellaneous products	Equipment	



5 1 1 6 0 a

CHAIN RETURN COMPONENTS

www.SystemPlastSmartGuide.com

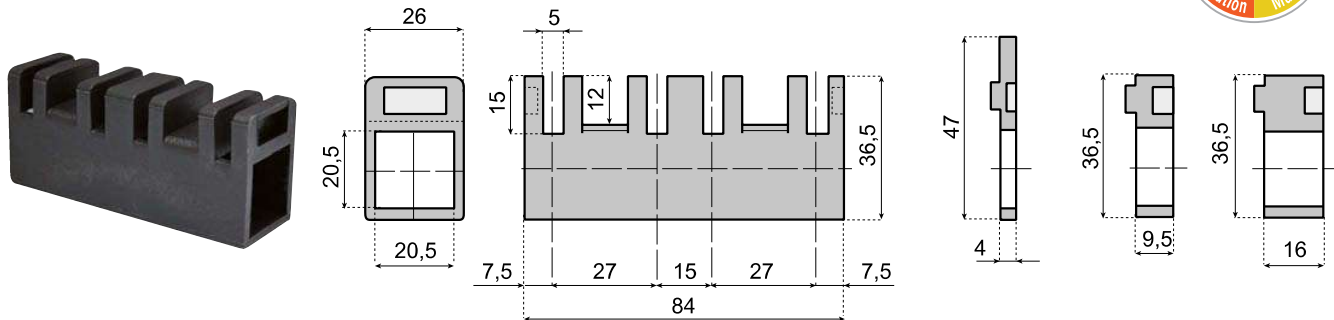

WASHER



MATERIAL					
	84	4	9.5	16	
ITEM DESCRIPTION					
PA BLACK	SPT-84-S20	SPT-4L26-S20	SPT-10L26-S20	SPT-16L26-S20	100

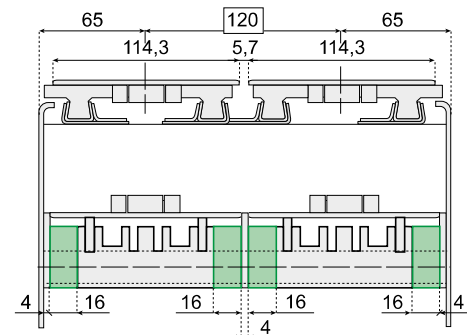
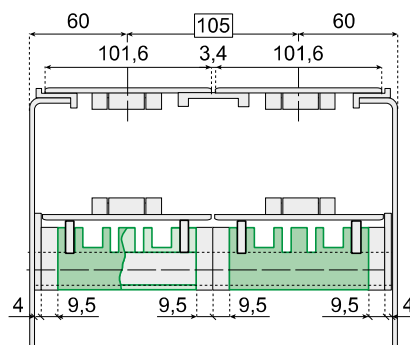

SLIDING SHOE



MATERIAL	FOR SQUARE SHAFT 20X20	
ITEM DESCRIPTION		
PE BLACK	SHOE-84L68-S20-PEB	100

Information about this product is only available on our Smart Guide® website.

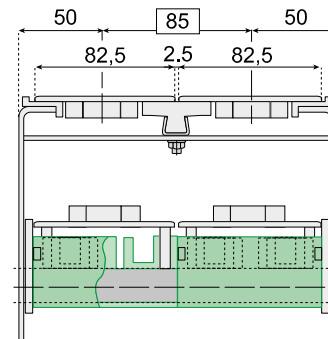
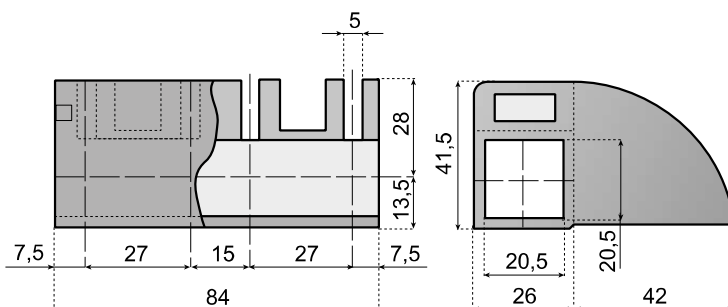

For standard solutions, go to: [5 1 0 6 0 a](http://www.SystemPlastSmartGuide.com)

Chains & sprockets	Wear strips	Side guide brackets & accessories	Levelers	Engineering manual
Modular belts & sprockets	Chain & belt return systems	Frame & structure supports	Bearing supports	
Curves & tracks	Side guide solutions	Miscellaneous products	Equipment	

51170a

SLIDING SHOE

www.SystemPlastSmartGuide.com

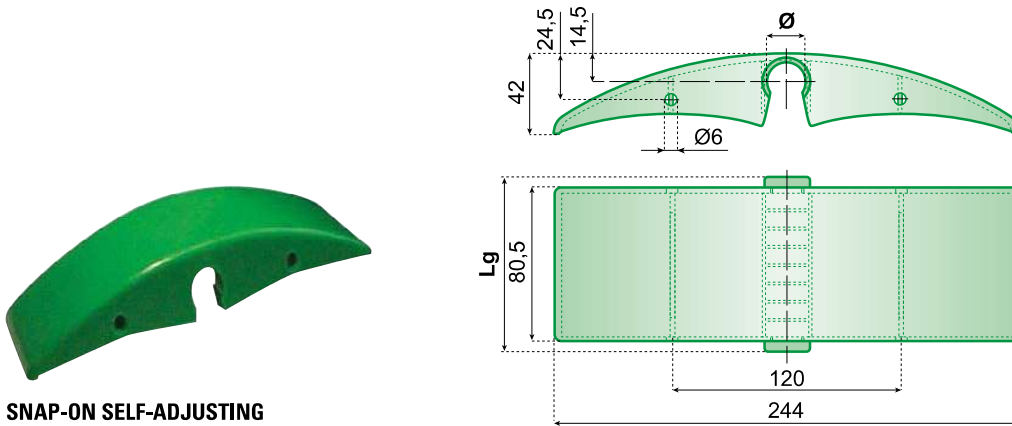

SNAP-ON SELF-ADJUSTING SLIDING SHOE

MATERIAL	ITEM DESCRIPTION		LG	
	Ø 18	Ø 20		
PE BLACK	SHOE-84L244-R18C-PEB ^{MOQ}	SHOE-84L244-R20C-PEB	84	50
	-	SHOE-85L244-R20C-PEB ^{MOQ}	85	
	-	SHOE-88L244-R20C-PEB	88	
PE GREEN	SHOE-84L244-R18C-PEG	SHOE-84L244-R20C-PEG	84	
	-	SHOE-85L244-R20C-PEG ^{MOQ}	85	
	-	SHOE-88L244-R20C-PEG	88	

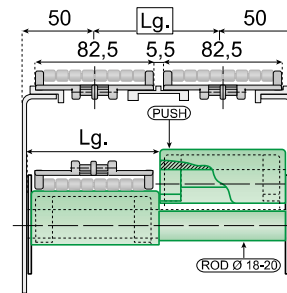

MOQ Min. order quantity: 300 pcs.



MATERIAL	ITEM DESCRIPTION	
PE GREEN	SHOE-89L162-S25C-PEG	100

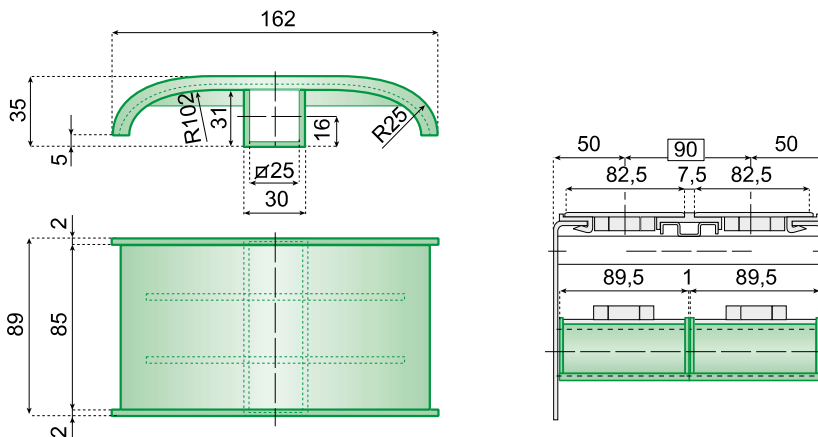

Chains & sprockets	Wear strips	Side guide brackets & accessories	Levelers	Engineering manual
Modular belts & sprockets	Chain & belt return systems	Frame & structure supports	Bearing supports	
Curves & tracks	Side guide solutions	Miscellaneous products	Equipment	

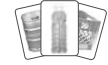

continue ►

7 3 5 8 6 a CHEMICAL RESISTANCE OF STANDARD MATERIALS MATERIALS

Data shown in the table was taken from laboratory tests performed on unstrained samples and are merely indicative.

Chemical resistance under normal working conditions can depend on various factors, such as stress and temperature, concentration of the chemical agent and contact time. Conveyor rinsing can also be a huge factor, as a corrosive chemical that is allowed to dry and concentrate will be more problematic than one that is allowed contact for a short time and thoroughly rinsed away.

VALID FOR AMBIENT TEMPERATURE (21°C / 70°F)

CHEMICAL AGENT	METALS								PLASTICS						RUBBERS											
	EXTRA		AISI 304		AISI 316		OT.NI		LF (POM)		NGE (PBT)		PP		PA		PE		EPDM		NBR		SEBS		VITON*	
	C%		C%		C%		C%		C%		C%		C%		C%		C%		C%		C%		C%		C%	
Acetic Acid	5	✓	20	✓	100	✓		○	5	✗	10	✓	40	✓	10	✗	10	✓	25	✓		✗	25	○	20	✗
Acetone		✓	25	✓		✓	✓			○		○		✓	100	✓		✓		✓		✗		○		✗
Acrylonitrile						✓								100	✓		✓			✓		✗		○		✗
Aluminium chloride					○	10	○							○	10	✓		✓		✓		✓		✓	SA	✓
Aluminium sulphate						SA	✓							✓	10	✓	SA	✓		✓		✓		✓	SA	✓
Amyl alcohol					✓		✓					✓		✓	10	✓			✓		✓		✓		✓	✓
Ammonia		✓	100	✓		✓		✗		✓		○	30	✓	10	✓		✓		✓		○		○		○
Ammonium chloride					○		✓						10	✓	10	✓		✓		✓		✓		✓	SA	✓
Aniline		✓				✓	✓						✓	100	○	3	✓		✗		✗		✗		✓	✓
Barium chloride					○	SA	✓						✓	10	✓		✓		✓		✓		✓		✓	✓
Beer		✓			✓		✓		✓				✓		✓		✓		✓		✓		✓		✓	✓
Benzene		✓	70	○		✓			✓				✓				○		✗						✗	✓
Benzoic acid			100	✓	SA		✓					✓	SA	○				✗		✓		✓		✗	✓	
Benzol					✓		✓		✓				○	100	✓		✓		✗		✗		✗		○	✓
Boric acid			○	SA	✓		✓			✗	10	✓	SA	✓	10	✓	SA	✓		✓		✓		✓	SA	✓
Brine	10	✗			○		✓						○		○		✓		✓				○			✓
Butter					✓		✓		✓				✓		✓		✓		✓		✓		○		✓	✓
Butyl acetate						✓			✓		○		○	100	✓		✓		○				○			✗
Butyl alcohol					✓				✓				✓	100	✓		✓		✓		○		✓		✓	✓
Butyl glycole						✓			✓				✓	100	✓		✓		✓				✓		✓	✓
Calcium chloride			✗		○		✓		✓				50	✓	10	✓	SA	✓		✓			✓	SA	✓	✓
Carbon sulphide					✓		✓		✓				✓	100	✓		○		✗		✗		✗			✓
Carbon tetrachloride					10	✓			✓				✗		✓					✗						✓
Chlorine water			✗		✗		○		✗		✗		✗				✓		3	○			3	○		✓
Chloroform			○	10	✓		✓		✓		✗		○	100	✗		✗		✗		✗		✗			✓
Chromic acid					25	✓	50	○		✗		○		1	○	50	○	50	○	✗		✗	50	✗	50	✓
Citric acid	10	✓			✓	SA		✗		○	10	✓	10	✓	10	○	SA	○	✓		✓		✓	SA	✓	✓
Cyclohexane						✓						✓		✓	100	✓		✓		✗		✓		✗		✓
Cyclohexanol						✓						○		✓	100	✓		✓		✗		✓		○		✓
Decalin						✓						○		✓				✗		○		○		✗		✗
Dioxane						✓			○		✓		○		✓		✓		○		✗		✗			✓
Distilled water		✓	10	✓		✓	✓		✓		✓		✓		✓		✓		✓		✓		✓			✗
Ethyl acetate						○		✓		○			✓	100	✓		✓			✗						○
Ethyl alcohol					✓				✓		✓	96	✓	96	✓	96	✓		○			○				✓
Ethyl chloride					✓			○		✓		✗		100	✓		○			○						✗
Ethyl ether						✓						✓		✓	100	✓		○								✓
Ferric chloride						○		✓		○	10	✓		✓	10	✓		✓		✓		✓		✓	SA	✓
Food fats		✓	100	✓		✓			✓		✓			✓		✓		○		○		○		○		✓
Food oils		✓			✓				✓		✓			✓		✓		○		○		○		○		✓

* Viton is believed to be the trademark and/or trade name of The Chemours Company FC, LLC and is not owned or controlled by Regal Beloit Corporation.

ABBREVIATION

- ✓ = good resistance
- = fairly good resistance depending on use conditions
- ✗ = insufficient resistance (not recommended)
- C = concentration
- SA = saturated
- blank spaces = no tests performed

All values are only applicable to temperatures below 21°C / 70°F.



MATERIALS AND CALCULATIONS - General index 7 3 5 1 0 a -

continue ►

7 3 5 6 0 a Steel chain materials

7 3 5 7 6 a Storage of plastic chains and belts & RoHs

7 3 5 8 0 a Coefficient of friction - Measurement procedure

7 3 5 7 3 a Nolu®-S parts

7 3 5 7 8 a Coefficient of friction of standard materials

7 3 5 8 8 a Application temperatures



Chains & sprockets	Wear strips	Side guide brackets & accessories	Levelers	Engineering manual
Modular belts & sprockets	Chain & belt return systems	Frame & structure supports	Bearing supports	
Curves & tracks	Side guide solutions	Miscellaneous products	Equipment	

7 3 5 8 6 b CHEMICAL RESISTANCE OF STANDARD MATERIALS MATERIALS

Data shown in the table was taken from laboratory tests performed on unstrained samples and are merely indicative.

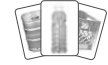

Chemical resistance under normal working conditions can depend on various factors, such as stress and temperature, concentration of the chemical agent and contact time. Conveyor rinsing can also be a huge factor, as a corrosive chemical that is allowed to dry and concentrate will be more problematic than one that is allowed contact for a short time and thoroughly rinsed away.

◀ back continue ▶

VALID FOR AMBIENT TEMPERATURE (21°C / 70°F)

CHEMICAL AGENT	METALS				PLASTICS					RUBBERS											
	EXTRA	AISI 304	AISI 316	OT.NI	LF (POM)	NGE (PBT)	PP	PA	PE	EPDM	NBR	SEBS	VITON*								
	C%	C%	C%	C%	C%	C%	C%	C%	C%	C%	C%	C%	C%								
Formaldehyde		✓	✓	✓	✓	✓	40	✓	30	✓	○	○	○	40	✗						
Formic acid	2	○	✗	100	✓	✓	10	✗	○	10	✗	85	✓	✓	○						
Freon 12			✓						✓	100	○		✓		✓						
Fresh water		✓	✓	✓		✓	✓	✓	✓	✓	✓	✓	✓	✓	✓						
Fruit juice		✓	○	✓		✓	✓	✓	✓	✓	✓	✓	✓	✓	✓						
Gasoline		✓	✓	✓	○	✓	○	○	✓	○	✗	○	✗	✗	✓						
Glycerine		✓	✓	✓	○	✓	✓	✓	✓	✓	✓	✓	✓	✓	✓						
Hydrochloric acid		✗	✗	✗	○	35	✗	20	○	30	✓	✗	35	✓	15	✓	15	✓	37	✓	
Hydrofluoric acid			✗	✗				5	○	40	✓	✗	70	✓		✗			48	✓	
Hydrogen peroxide	3	✓	✓	100	✓		30	✓	5	✓		✗	10	○	30	○	✗	30	✗	90	✓
Isopropyl alcohol				✓		✓	✓	✓	✓	✓	✓	✓	✓	✓	✓	✓	✓	✓	✓	✓	✓
Lactic acid		○		✓	✗	✓	10	✓	20	✓	✓	✓	✓	○	✓	○	✓	○	✓	✓	
Linseed oil			✓	✓		✓	✓	✓	✓	✓	✓	✓	✓	○	✓	○	✓	✗		✓	
Magnesium chloride			○	✓			✓	✓	✓	✓	✓	✓	✓	✓	✓	✓	✓	✓	SA	✓	
Methyl acetate			○	✓		○	○	✓	✓	✓	✓	✓	✓	○	✗	✗	✗	✗	✗	✓	
Methyl alcohol			80	✓	✓	✓	✓	✓	✓	✓	✓	✓	✓	✓	○	✓	○	✓	○	✓	
Methylene chloride		○	○	✓	✓	✗	✗	○	○	○	○	○	○	✗	✗	✗	✗	✗	○	✓	
Milk		✓	✓	✓	✓	✓	✓	✓	✓	✓	✓	✓	✓	○	○	✓	✓	✓	✓	✓	
Mineral oil			✓	✓		✓	✓	✓	✓	✓	✓	✓	✓	✗	✓	✓	✗	✓	✓	✓	
Nitric acid	25	○	65	✓			✗		✓	✓	✗	○			10	✗			70	✓	
Nitrobenzene				✓			✓	✓	✓	○	✓	✓	✗	✗	○	○	○	○	○	○	
Oxalic acid			65	✓	✓			10	✓	✓	○	○	✓	○	○	○	○	○	○	✓	
Paraffin				✓		✓	✓	✓	✓	✓	✓	✓	✓	○	○	○	✗		✓		
Petroleum			✓	✓	✓	✓	✓	✓	✓	✓	✓	✗	✗	✗	✓	✓	✗	✗	✓		
Petroleum ether			✓	✓	✓	✓	○	○	✓	✓	✓	✓	✓	✗	✗	✗	✗	✗	✓		
Phenol			✓	✓	✓	○	○	✗	✓	✓	✓	✓	○	○	○	○	○	○	○	✓	
Phosphoric acid	25	○	✗	✓	✓	✗	✗	✗	✓	✓	✓	✓	✓	✓	20	○	○	✓	85	✓	
Potassium bichromate				SA	✓			○	✓	○	SA	✓	✓	✓	○	○	○	SA	✓		
Potassium bromite				✓				✓	✓	✓	10	✓	✓	✓	✓	✓	✓	✓	✓	✓	
Potassium hydroxide		✓	50	✓	✓		✓	✗	✓	✓	✓	✓	✓	✓	○	○	✓	✓	✓	✓	
Potassium permanganate			✓	✓	✓	10	○	○	✓	✓	✗	✓	10	✓	✓	✗	10	○	○	✓	
Sea water		✗	✓	✓	✓	○	○	✓	✓	✓	✓	✓	✓	✓	✓	✓	✓	○	○	✓	
Silicone oil				✓				✓	✓	✓	✓	✓	✓	✓	✓	✓	✓	✓	✓	✓	
Silver nitrate			○	✓				✓	✓	✓	✓	✓	✓	○	○	○	○	○	○	✓	
Sodium carbonate		✓	100	○	SA	✓	10	✓	10	✓	✓	✓	✓	✓	✓	✓	✓	✓	✓	✓	
Sodium chloride		○	○	✓	✓		✓	10	✓	✓	✓	✓	✓	✓	✓	✓	✓	✓	SA	✓	
Sodium hydroxide	40	✓	✓	60	✓		✓	10	✗		✓	✓	✓	✓	○	○	✓	✓	✓	✓	
Sodium hypochlorite			✗	SA	○		✗	10	✓	✓	✓	✓	10	✓	✓	✗	10	○	5	✓	
Sodium silicate			100	✓	✓					✓	✓	✓	✓	✓	✓	✓	✓	✓	✓	✓	

* Viton is believed to be the trademark and/or trade name of The Chemours Company FC, LLC and is not owned or controlled by Regal Beloit Corporation.

ABBREVIATION

- ✓ = good resistance
- = fairly good resistance depending on use conditions
- ✗ = insufficient resistance (not recommended)
- C = concentration
- SA = saturated
- blank spaces = no tests performed

All values are only applicable to temperatures below 21°C / 70°F.



MATERIALS AND CALCULATIONS - General index 7 3 5 1 0 a -

◀ back continue ▶

7 3 5 6 0 a Steel chain materials

7 3 5 7 6 a Storage of plastic chains and belts & RoHs

7 3 5 8 0 a Coefficient of friction - Measurement procedure

7 3 5 7 3 a Nolu®-S parts

7 3 5 7 8 a Coefficient of friction of standard materials

7 3 5 8 8 a Application temperatures

Chains & sprockets	Wear strips	Side guide brackets & accessories	Levelers	Engineering manual
Modular belts & sprockets	Chain & belt return systems	Frame & structure supports	Bearing supports	
Curves & tracks	Side guide solutions	Miscellaneous products	Equipment	

7 3 5 8 6 c CHEMICAL RESISTANCE OF STANDARD MATERIALS MATERIALS

Data shown in the table was taken from laboratory tests performed on unstrained samples and are merely indicative.

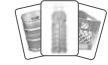

Chemical resistance under normal working conditions can depend on various factors, such as stress and temperature, concentration of the chemical agent and contact time. Conveyor rinsing can also be a huge factor, as a corrosive chemical that is allowed to dry and concentrate will be more problematic than one that is allowed contact for a short time and thoroughly rinsed away.



VALID FOR AMBIENT TEMPERATURE (21°C / 70°F)

CHEMICAL AGENT	METALS				PLASTICS					RUBBERS			
	EXTRA	AISI 304	AISI 316	OT.NI	LF (POM)	NGE (PBT)	PP	PA	PE	EPDM	NBR	SEBS	VITON*
	C%	C%	C%	C%	C%	C%	C%	C%	C%	C%	C%	C%	C%
Sodium sulphate		100	✓	✓					SA	✓	○	✓	✓
Soft drinks			✓	✓	✓		✓	✓	✓	✓	✓	✓	✓
Suds			✓	✓		10	✓	✓	✓	✓	✓	✓	✓
Sulphuric acid	✗	✗	○	✓	✗	2	✓	✓	✗	80	50	✓	✗
Tartaric acid	✓	50	✓	✓	✗	○	50	✓	✓	✓	○	✓	✓
Tetrahydrofuran				✓	○	✓	○	✓	○	✗	✗	✗	✗
Tetralin		✗	✓		✓	✓	✗	✓	✓	✗	✗	✗	✓
Tincture of iodine		○	✓	✗			✓	✓	✓	○	✗	○	✓
Toluol	✓			✓			✓	✓	✓	✗	✗	✗	○
Transformer oil	✓			✓	✓		○	✓	✓	✗	✓	✗	✓
Trichloroethylene		✗	100	✓	○	✗	○	○	○	✗	✗	✗	✓
Triethanolamin				✓			✓	✓	✓	○	✗	○	✗
Turpentine	✓	✓			✗	✓			○	✗	✗	✗	✓
Vaseline				✓					○	✗	✓	✗	✓
Vegetable juice	✓	✓	✓	✓	✓	✓	✓	✓	✓	✓	✓	✓	✓
Vegetable oils	✓	✓	✓	✓	✓	✗	✓	✓	✓	○	✓	○	✓
Vinegar	✓	✓	100	✓	✓	10	✓	✓	✓	25	✓	○	25
Water and soap	✓	✓	✓	✓	✓	✓	✓	✓	✓	✓	✓	✓	✓
Whisky	✓	✓	✓	✓	✓	✓	✓	✓	✓	✓	✓	✓	✓
Wine	✓	✓	✓	✓	✓	✓	✓	✓	○	✓	✓	✓	✓
Xilol	✓	✓	✓	○	✗	✓	✗	✓	✓	✗	✗	✗	✓

* Viton is believed to be the trademark and/or trade name of The Chemours Company FC, LLC and is not owned or controlled by Regal Beloit Corporation.

ABBREVIATION

- ✓ = good resistance
- = fairly good resistance depending on use conditions
- ✗ = insufficient resistance (not recommended)
- C = concentration
- SA = saturated
- blank spaces = no tests performed

All values are only applicable to temperatures below 21°C / 70°F.

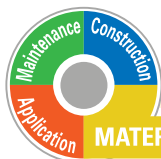

MATERIALS AND CALCULATIONS - General index 7 3 5 1 0 a -



7 3 5 6 0 a Steel chain materials

7 3 5 7 6 a Storage of plastic chains and belts & RoHs

7 3 5 8 0 a Coefficient of friction - Measurement procedure

7 3 5 7 3 a Nolu®-S parts

7 3 5 7 8 a Coefficient of friction of standard materials

7 3 5 8 8 a Application temperatures



Chains & sprockets	Wear strips	Side guide brackets & accessories	Levelers	Engineering manual
Modular belts & sprockets	Chain & belt return systems	Frame & structure supports	Bearing supports	
Curves & tracks	Side guide solutions	Miscellaneous products	Equipment	



7 3 5 8 8 a APPLICATION TEMPERATURES MATERIALS

For low and high temperature application please consult our Application Engineering department.

Be aware:

- If a chain, belt or other component is composed of several materials, all materials will have to be considered individually.
- Please note that the properties of a material change when the temperature changes
- In general, the impact resistance is reduced at low temperatures.
- The strength and wear resistance are reduced at elevated temperatures.
- High temperatures can also influence chemical resistance
- Some materials absorb moisture and expand/swell

MATERIAL	SYMBOL	USER FOR	MIN TEMP. °C	MAX. TEMP. °C		MIN TEMP. °F	MAX. TEMP. °F	
				DRY	WET		DRY	WET
Carbon steel	C45	Steel chains, roller chains	-70	180	not recommended	-95	350	not recommended
Ferritic stainless steel	Standard	Steel chains	-30	400	130	-20	750	265
Extra stainless steel	Extra	Steel chains	-30	400	130	-20	750	265
Extra plus stainless steel	Extra plus	Steel chains	-30	400	130	-20	750	265
Austenitic stainless steel	Austic	Steel chains, roller chains	-30	400	130	-20	750	265
Acetal resin	D,W	Plastic chains	-40	80	65	-40	175	150
Low friction acetal resin	LF (all colors)	Plastic chains and belts	-40	80	65	-40	175	150
Anti static acetal resin	AS	Plastic chains and belts	-40	80	not applicable	-40	175	not applicable
NG[®]evo conveyor components made from engineered plastic resin	NG[®]evo	Plastic chains and belts	-40	120	60	-40	250	140
Polypropylene	PP	Plastic chains and belts	5	104	104	41	220	220
Chemical resistant	CR	Plastic chains	5	104	104	41	220	220
Polyamide - PA High temperature resistance	HT	Plastic chains and belts	0	140	not applicable	30	285	not applicable
Polyphenylene sulfide Extra high temperature resistance	XT	Plastic chains and belts	-40	240	not applicable	-40	464	not applicable
Polyamide - PA Abrasion resistance	AR	Plastic chains	0	90	90	30	195	195
Thermoplastic rubber SEBS	TPR	VG chains and belts, gripper chains	-40	100	100	-40	210	210
NBR rubber	NBR	Gripper chains	-25	100	100	-15	210	210
EPDM rubber	EPDM	Gripper chains	-40	120	120	-40	250	250
EPDM-PP rubber	EPDM-PP	Gripper chains	-40	120	120	-40	250	250
Polyamide	PA	Sprockets, components	0	90	90	30	195	195
Polyamide reinforced	PA FV	Sprockets, bearing, components	0	90	90	30	195	195
Polypropylene	PP	Components	5	104	104	41	220	220
Polypropylene reinforced	PP FV	Bearing, components	5	104	104	41	220	220
Polyethylene	PE	Curves, components	-40	80	80	-40	175	175
Nolu [®] -S parts	Nolu [®] -S parts	Curves, components	-40	80	80	-40	175	175



MATERIALS AND CALCULATIONS - General index 7 3 5 1 0 a -

7 3 5 6 0 a Steel chain materials

7 3 5 7 6 a Storage of plastic chains and belts & RoHs

7 3 5 8 0 a Coefficient of friction - Measurement procedure

7 3 5 7 3 a Nolu[®]-S parts

7 3 5 7 8 a Coefficient of friction of standard materials

7 3 5 8 6 a Chemical resistance of standard materials



Chains & sprockets	Wear strips	Side guide brackets & accessories	Levelers	Engineering manual
Modular belts & sprockets	Chain & belt return systems	Frame & structure supports	Bearing supports	
Curves & tracks	Side guide solutions	Miscellaneous products	Equipment	

SYSTEM PLAST®

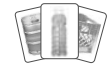

continue ►

7 3 7 0 0 a NG® EVO CONVEYOR COMPONENTS MADE FROM ENGINEERED PLASTIC RESIN

NG®
evo

Plastic Chains & Modular Belts

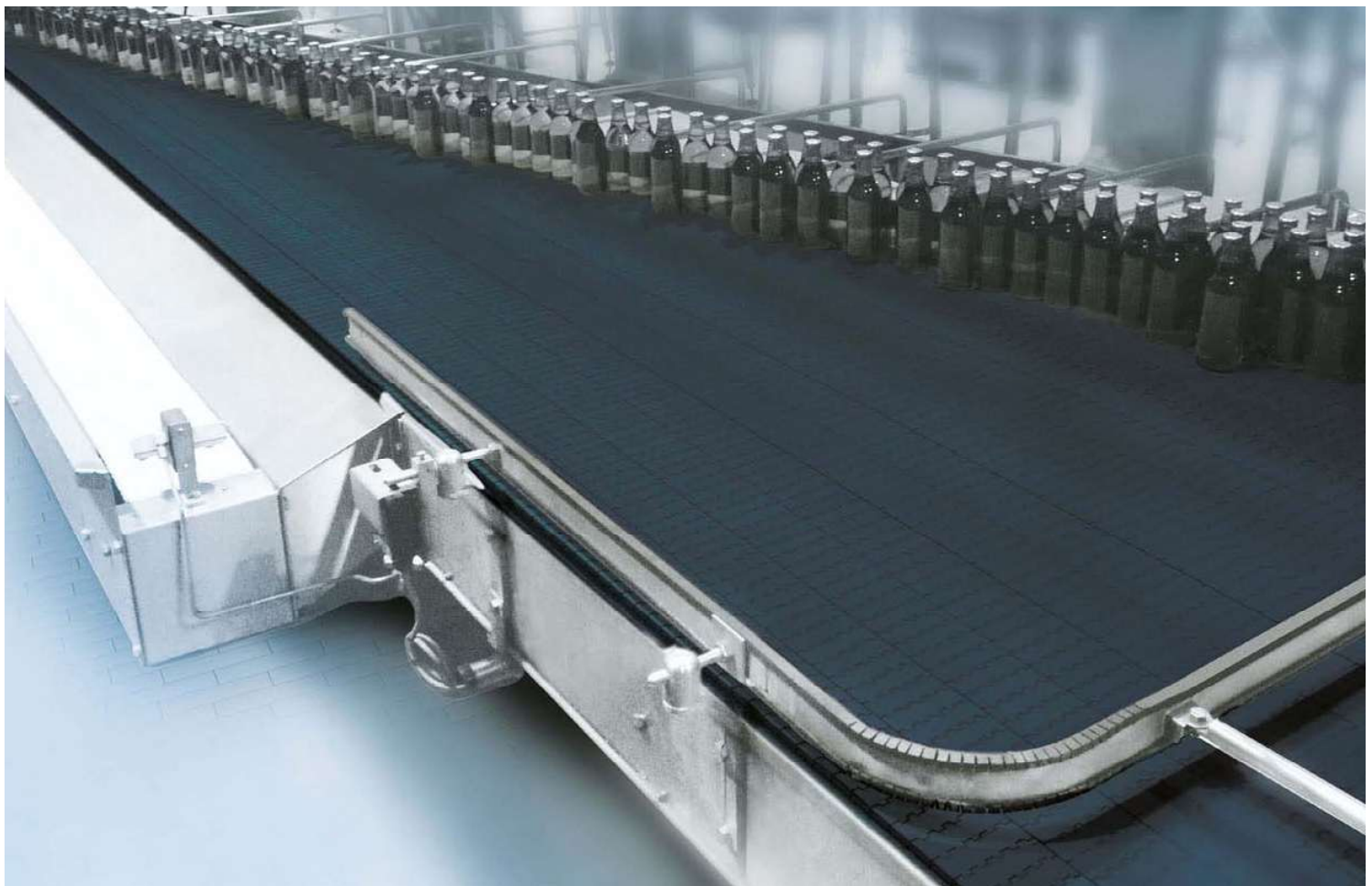

MATERIALS AND CALCULATIONS - General index **7 3 5 1 0 a -**

continue ►

Revision 001



Chains & sprockets	Wear strips	Side guide brackets & accessories	Levelers	Engineering manual
Modular belts & sprockets	Chain & belt return systems	Frame & structure supports	Bearing supports	
Curves & tracks	Side guide solutions	Miscellaneous products	Equipment	

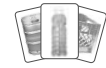

7 3 7 0 1 a NG® EVO CONVEYOR COMPONENTS MADE FROM ENGINEERED PLASTIC RESIN



WHAT PLASTIC MATERIALS ARE USED IN NEW GENERATION® CONVEYOR COMPONENTS?

The System Plast® New Generation® family of chains and belts conveyor components are made of proprietary engineered resins designed to provide a sustainable advantage over “industry standard” materials. Their reduced coefficient of friction properties enable end users to reduce or eliminate their chain/belt lubrication thus providing a true “dry running” conveyor. Better sliding properties also result in reduced power consumption, increased wear life, reduced dust generation and the ability to run at higher speeds.

SYSTEM PLAST PRODUCTS ARE LEADING THE WAY WITH INNOVATION!

We introduced the New Generation® brand of conveyor components 20 years ago. It was soon recognized to offer new possibilities for running conveyors lines without lubrication. This enabled the reduction/elimination of soap & water or dry lubricants creating a safer work environment and cost savings. NG® conveyor components have also proven they provide longer wear life in comparison to acetal materials, and reduce noise levels in dry applications.

Regal expertise with unique materials and in-house integrated tool development is critical for consistent control over design and manufacturing processes.

MATERIAL EVOLUTION TO MEET YOUR GOALS

Understanding the growing demands on safety, hygiene, sustainability and TCO (total cost of ownership) - Regal challenged itself to improve the original formulation. This successful development created a new and improved resin used to make NG® Evolution conveyor components which helps to meet your goals. Your floors can be drier, bacteria growth can be reduced, energy and water consumption can be less and your TCO will be improved.

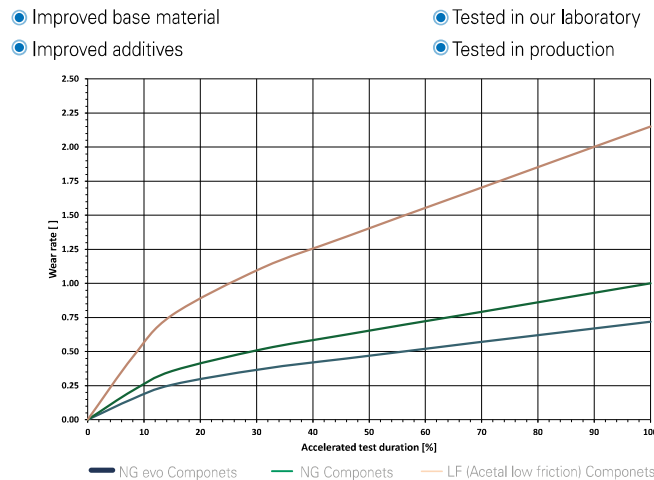

IMPROVEMENTS OF NG® EVO COMPARED TO NG® CONVEYOR COMPONENTS

- Lower friction - Friction is reduced up to 15%.
- Higher strength - Up to 10%
- Higher abrasion resistance
- Approved for direct food contact according to EU and FDA regulations



Chains & sprockets	Wear strips	Side guide brackets & accessories	Levelers	Engineering manual
Modular belts & sprockets	Chain & belt return systems	Frame & structure supports	Bearing supports	
Curves & tracks	Side guide solutions	Miscellaneous products	Equipment	



◀ back continue ▶

7 3 7 0 2 a NG® EVO CONVEYOR COMPONENTS MADE FROM ENGINEERED PLASTIC RESIN

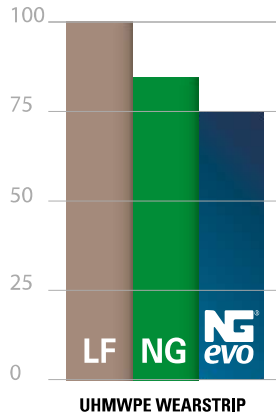

LOWEST COEFFICIENT OF FRICTION BETWEEN CHAIN /BELT AND WEARSTRIP

Coefficient of friction NG® evo conveyor components on UHMWPE wearstrip:

- 25% lower than LF acetal chain
- 15% lower than NG chain

Coefficient of friction values of 0,10 or even less are achievable in running dry applications

- Less power consumption
- Improved product stability
- Improved product flow
- Improved productivity

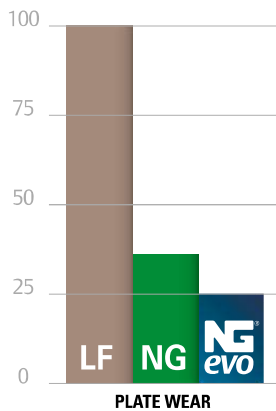

HIGHEST PLATE WEAR RESISTANCE

Plate wear in accelerated abrasion test after 5400 km run length

- 75% less wear than LF acetal chain
- 30% less wear than NG chain

Increased wear provides many advantages

- Less dust generation
- Reduced contamination
- Reduced cleaning requirements

NG® EVO CONVEYOR COMPONENTS ARE APPROVED FOR DIRECT FOOD CONTACT ACCORDING TO EU AND FDA REGULATIONS

NOISE REDUCTION:

With NG evo components the risk of noisy chains is greatly reduced compared to LF acetal chains. Squealing curves can be resolved and improve the work environment.

HIGH PV (PRESSURE VELOCITY) LIMIT:

With NG evo conveyor components, higher speeds and higher loads are achievable in dry running lines compared to LF Acetal chains. Additional speed and wear advantages can be also gained when used in combination with NOLU®-S or NOLU-SR curves.

CHEMICAL RESISTANCE:

NG evo conveyor components have a better chemical resistance than LF acetal materials, being compatible with most cleaning agents, especially in aseptic filling with the presence of H₂O₂ (hydrogen peroxide). The material in NG evo components, unlike many other materials used in the same application, do not get attacked by this chemical.

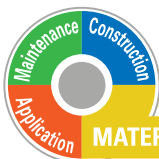

◀ back continue ▶

Chains & sprockets	Wear strips	Side guide brackets & accessories	Levelers	Engineering manual
Modular belts & sprockets	Chain & belt return systems	Frame & structure supports	Bearing supports	
Curves & tracks	Side guide solutions	Miscellaneous products	Equipment	



◀ back continue ▶

ENHANCED RUNNING DRY POSSIBILITIES WITH NG® EVO CONVEYOR COMPONENTS:

Contact Regal for assistance to help you achieve this goal.

An overview of the process is shown below :

STEP 1: GOAL TO RUN DRY

- Save water / lubricant consumption
- Eliminate wet floors • safety
- Less bacteria growth • hygiene
- Reduce maintenance
- Reduce energy consumption

STEP 2: DEFINE PROCESS PARAMETERS

- Layout
- Production / hour • speeds
- Geometry bottle, can, etc.

STEP 3: DEVELOP A ROBUST PROCESS

- Analyze the data from the previous step
- Discuss requirements and conditions with OEM and End user
- Select the correct products

STEP 4: IMPLEMENT DRY RUNNING

- Advise during installation
- Train operators

STEP 5: CONTROL AND IMPROVE PROCESS

- Monitor, follow up and make changes if necessary
- Analyze the collected data

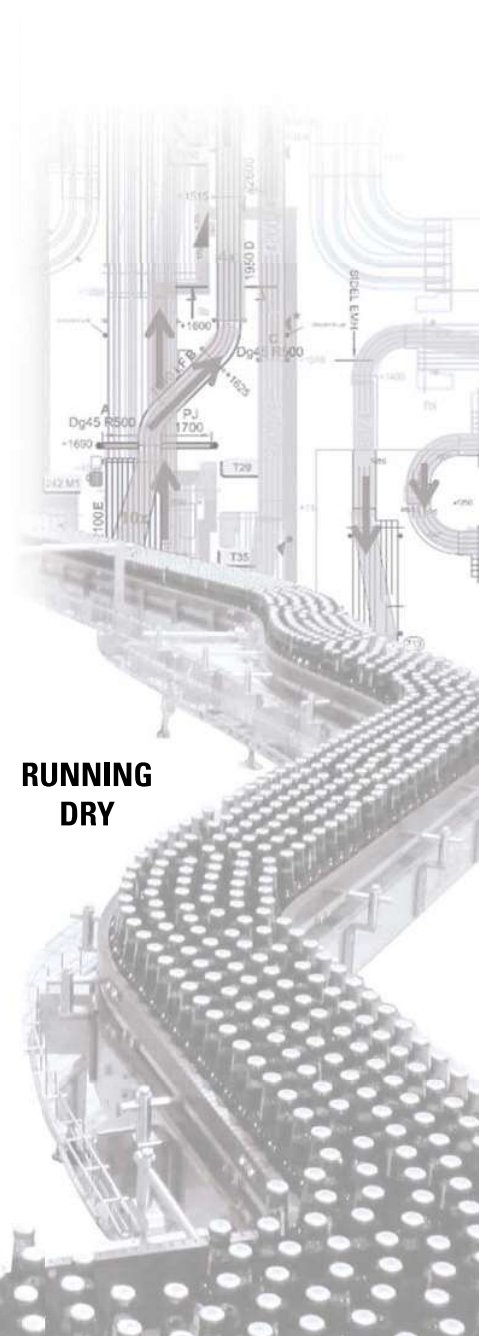

RUNNING DRY

◀ back continue ▶

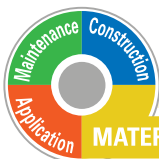

Chains & sprockets	Wear strips	Side guide brackets & accessories	Levelers	Engineering manual
Modular belts & sprockets	Chain & belt return systems	Frame & structure supports	Bearing supports	
Curves & tracks	Side guide solutions	Miscellaneous products	Equipment	



A SUCCESS STORY OF NG® CONVEYOR COMPONENTS



◀ back



DRY RUNNING SYSTEM PLAST® CONVEYOR COMPONENTS HELP HEINEKEN BREW A BETTER FUTURE WITH WATERLESS BOTTLING CONVEYORS IN ZOETERWOUE PLANT

THE TWO WATER FOOTPRINT NETWORK PARTNERS TEAM UP TO IMPROVE PLANT SAFETY AND SUSTAINABILITY BY REDUCING WATER USE, ENERGY CONSUMPTION, AND SOUND LEVELS AT ZOETERWOUE BREWERY.

Zoeterwoude, Netherlands 2014 - Heineken* N.V.'s global sustainability strategy, known as "Brewing a Better Future," produced a company-wide reduction of 20 percent in water use between 2008 and 2013. Playing a role in that improvement are System Plast NG® conveyor chain/belts and NOLU®-S wear track from System Plast S.r.l., a subsidiary of Regal Beloit Corporation (referred to from here on as "Regal"). The ultra-low-friction components, which are being deployed in phases at Heineken's Zoeterwoude brewery, eliminate the need for water and chemical-based lubrication on the filling lines - including those where abrasive particles from aluminum cans, party kegs and returnable glass bottles have been a problem in the past.

According to managers at the brewery, the dry running conveyor is producing a cascade of sustainability improvements with a cleaner, quieter, more energy-efficient and reliable plant. "We have experienced a wide variety of gains from the System Plast dry running conveyor," said Mr. Cok Duivenvoorden, Technical Line Manager at Zoeterwoude. "Specifically, we have improved plant safety and hygiene with dry equipment and floors. Maintenance is easier because of the cleanliness and better access where drip trays have been removed. We have reduced costs for water, lubricating chemicals and wastewater discharge. Dry operation is easier on conveyor bearings and frames, yet still reduces energy consumption because of the low-friction components. System Plast NG chain lasts up to five times longer than

low-friction acetal in some of our applications. And when installed to replace worn-out conveyor, the new chain pays for itself in as little as a year."

A JOINT GOAL TO REDUCE WATER USE IN BEVERAGE PROCESSING

One goal of Heineken's "Brewing a Better Future" sustainability program is to reduce water consumption by at least 25% by 2020, and both Heineken and Regal are pursuing dry conveying solutions as members of the Water Footprint Network. The network is a global organization of businesses, governmental agencies and environmental groups that promotes the transition to sustainable use of fresh water resources through increased awareness of how production and consumption of goods affect fresh water systems.



*Heineken is believed to be a trademark and/or trade name of Heineken Brouwerijen B.V. and is not owned or controlled by Regal Beloit Corporation.

◀ back

Chains & sprockets	Wear strips	Side guide brackets & accessories	Levelers	Engineering manual
Modular belts & sprockets	Chain & belt return systems	Frame & structure supports	Bearing supports	
Curves & tracks	Side guide solutions	Miscellaneous products	Equipment	



7 3 9 9 5 a APPLICATION CONSIDERATIONS

The proper selection and application of power transmission products and components, including the related area of product safety, is the responsibility of the customer. Operating and performance requirements and potential associated issues will vary appreciably depending upon the use and application of such products and components. The scope of the technical and application information included in this publication is necessarily limited. Unusual operating environments and conditions, lubrication requirements, loading supports, and other factors can materially affect the application and operating results of the products and components and the customer should carefully review its requirements. Any technical advice or review furnished by Regal Beloit America, Inc. and its affiliates with respect to the use of products and components is given in good faith and without charge, and Regal assumes no obligation or liability for the advice given, or results obtained, all such advice and review being given and accepted at customer's risk.

For a copy of our Standard Terms and Conditions of Sale, Disclaimers of Warranty, Limitation of Liability and Remedy, please contact Customer Service.

These terms and conditions of sale, disclaimers and limitations of liability apply to any person who may buy, acquire or use a Regal Beloit America Inc. product referred to herein, including any person who buys from a licensed distributor of these branded products.

INSPECTION AND MAINTENANCE 73010a

72110a CONSTRUCTION DETAILS

APPLICATIONS 72510a

73510a MATERIALS AND CALCULATIONS



Chains & sprockets	Wear strips	Side guide brackets & accessories	Levelers	Engineering manual
Modular belts & sprockets	Chain & belt return systems	Frame & structure supports	Bearing supports	
Curves & tracks	Side guide solutions	Miscellaneous products	Equipment	

Item description	Page code	Item description	Page code	Item description	Page code	Item description	Page code
1400..D	11590a	820..WL	11050a	BKR-77W43P..	53535a	CL-RD8-PD..	51650a
1400..R	11590a	820..WML	11050b	BKR-77W43S..	53535a	CL-RD8-PF	51650a
1400V..R	11600a	820..WMS	11050b	BKR-84W31LP..	53525b	CON..	50600a
1700..D	11550a	820..WS	11050a	BKR-85W44P..	53545b	CON-H7816M-S	51690a
1700..DMS	11550a	821..D	11320b	BKR-87W31LP..	53525b	CON-H8716M-S	51700a
1700..RB	11560a	821..R	11320b	BKR-88W43P..	53535b	CRBFTRS..	56044a
1700..RC	11560a	821..W	11320b	BKR-93W43LP..	53535b	CRBFTRS..	56074a
1700..RM	11550a	821..WMS	11320b	BKZ-154-SS	53580a	CS..	56100a
1700..RMS	11550a	878..D	11270a	BPS-4020..	54040a	CSHOE..	50600a
1874..	11140a	878..RB	11270a	CAP-10M..	53605a	DS-25M52	54520a
1874..	11450a	878..RC	11270a	CAP-25M..	54530a	DS-30M52	54520a
2080..DM	30027a	880..DMS	11260a	CAP-30M..	54530a	DTS..	53600a
2080..DMS	30027a	880..DS	11260a	CAP7023-P-YT	56300b	F-100..	51090a
2120..	30160a	880..RMS	11260a	CAP7023-B30M..	56300b	F-26..	51090a
2120..DS-PK2	30160c	880..RS	11260a	CAP8437-P-YT	56300b	F-50..	51090a
2122..	30166a	880T..W	11260d	CAP-8437-B40M..	56300b	F-60..	51090a
2124..	30165a	880T..WMS	11260d	CAP-50M..	54530a	F-70..	51090a
2190..	30235a	881..DMS	11090a	CC-16..	53610a	F-90..	51090a
2250..	30395a	881..DS	11090a	CC-19-12MK-12MK	53620a	FT-HDL..	54560a
2251..	30550a	881..RMS	11090a	CC-20..	53620a	FT-LOCK..	54570a
2256..	30740a	881..RS	11090a	CC-25-12MK..	53620a	FT-MAG..	54570a
2256ST..	30740b	881T..W	11090b	CC-25-14M..	53615a	GRSHOE-S330	50600b
2260..	30715a	881T..WMS	11090b	CC-25-15M..	53615a	GNP..	56300a
2260..DS-PK2	30715b	882..DMS	11300a	CC-25-16M..	53615a	GP..	54540a
2351..	30760a	882..DS	11300a	CC-25-18M..	53615a	GRINGK..	11090d
2500..	30615a	882..RMS	11300a	CC-25-20M..	53615a	GRP.EPDM	11440b
2502..	30618a	882..RS	11300a	CC-42-12MK..	53620a	GRP.NBR	11440a
2508..	30640a	882T..W	11300b	CC-42-12MQ..	53630a	GRPK.NBR	11440a
2630..	30650a	BCK..	50600a	CC-52-R..	53650a	GRPN..NBR	11430a
500..	56300b	BEC-19	56044a	CC-52-S..	53645a	GRSHOE-S330	50600b
515..DMS	11130a	BEC-24	56074a	CJ..	54520a	HDL-117..	54560a
515..RMS	11130a	BEO-19	56044a	CL..	56090a	HDL-120..	54560a
600..RM	11580a	BEO-24	56074a	CL-1020S	52550a	HDL-94..	54560a
800..DMS	11120a	BK-47W44..	53545b	CL-1540S	52530a	HNG..	54550a
800..DMS-F	11120b	BK-49W31L	53525b	CL-6065X38	50600a	HUB110..	11270a
800..DMS-FSS	11120b	BK-50W43	53535b	CL-CON-P..	51600a	ICOF-CAN	57080a
800..RMS	11120a	BK-55W43L	53535b	CL-CON-P25..	51630a	ICOF-GLASS	57080a
800..WMS	11120b	BKE-85W22..	53555a	CL-CON-PD..	51610a	ICOF-PET	57080a
800..FSS	11120b	BKF-35W31L..	53555a	CL-CON-R	51820a	ICOF-SLIDER-CAN	57080a
815..D	11040a	BKF-61W38..	53560a	CL-D..	51660a	ICOF-SLIDER-GLASS	57080a
815..DMS	11040b	BKF-65W30L..	53555a	CL-H45S	52521a	ICOF-SLIDER-PET	57080a
815..DMS-F	11090d	BKF-66W31L..	53515a	CL-H5210..	52594a	IND-142B..	53635a
815..DS	11040a	BKF-66W31L..	53515b	CL-H7816M..	51690a	IND-350R..	53635a
815..FSS	11090d	BKF-79W30..	53555a	CL-H8716M..	51700a	MODFLEX...A90R	57035a
815..RMS	11040b	BKF-89W38..	53560a	CL-H9014M..	51680a	MODFLEX...A180R	57055a
8157..DMS	11100a	BKL..SS	53580a	CL-RD10-P..	51640a	MODFLEX...A90L	57040a
8157..DMS-F	11100b	BKR-67W44P..	53545b	CL-RD10-P258M	51650a	MODFLEX...A180L	57060a
8157..FSS	11100b	BKR-69W31LP..	53525a	CL-RD10-PD..	51650a	MODFLEX...A90R-TM	57045a
820..D	11200a	BKR-69W31LP..	53525b	CL-RD12-P..	51640a	MODFLEX...A180R-TM	57065a
820..DM	11200b	BKR-69W31LS..	53525a	CL-RD12-P258M	51650a	MODFLEX...A90L-TM	57050a
820..DMS	11200a	BKR-69W44P..	53545a	CL-RD12-PD..	51650a	MODFLEX...A180L-TM	57070a
820..DS	11200a	BKR-69W44S..	53545a	CL-RD14-P..	51640a	MODSORT-AI2..	57015a
820..RM	11200b	BKR-70W43P..	53535b	CL-RD14-P258M	51650a	MODSORT-MSGK...	57020a
820..RMS	11200b	BKR-72W43P..	53535a	CL-RD20-P..	51640a	MODSORT-MPES..	57020a
820..RS	11200b	BKR-72W43S..	53535a	CL-RD8-P..	51640a	MODSORT-MPEK	57020a
820..W	11050a	BKR-75W43LP..	53535b	CL-RD8-P258M	51650a	MODSORT-MPS...	57020a

Legend

Codes ending with .. indicate a group of item descriptions all starting with the code listed. Example: 2122.. (all item descriptions starting with 2122).
 Codes with .. in the middle indicate a group of item descriptions starting and ending with the codes listed. Example 2251..RS (all item descriptions starting with 2251 and ending with RS). **Information about item descriptions, printed in blue, is only available on our website: www.SystemPlastSmartGuide.com**

Chains & sprockets	Wear strips	Side guide brackets & accessories	Levelers	Engineering manual
Modular belts & sprockets	Chain & belt return systems	Frame & structure supports	Bearing supports	
Curves & tracks	Side guide solutions	Miscellaneous products	Equipment	

Item description	Page code	Item description	Page code	Item description	Page code	Item description	Page code
KMD01..	50050a	KNF-50H56..	54600a	LF879TAB..	11230a	LFG2251FT-P.VG-3	30490c
KMD02..	50050a	KNF-53H45..	54600a	LF880..	11240a	LFG2251FT-PT.VG	30490d
KMD03..	50020a	KNF-80H51..	54600a	LF8800P..	11240b	LFG2251FT-PT.VG-2	30490d
KMD04..	50020a	KNM-20H13..	54610a	LF880M..	11220a	LFG2251FT-PT.VG-3	30490d
KMD05..	50050a	KNM-25H16..	54610a	LF880TAB..	11230a	LFG2251FT-PT.VGS	30495d
KMD06..	50020a	KNM-30H21..	54610a	LF882M..	11280a	LFG2251FT-PT.VGS-2	30495d
KMD07..	50020a	KNM-40H26..	54610a	LF882TAB..	11290a	LFG2251FT-PT.VGS-3	30495d
KMD08..	50020a	KNM-50H32..	54610a	LFB2080FT..	30025a	LFG2251FT-TAB..	30710a
KMD09..	50020a	KNM-50H40..	54600a	LFB2120FG..	30070a	LFG2251LBP..	30500a
KMD10..	50020a	LA100..	55585a	LFB2120FT..	30050a	LFG2252PT..	30481a
KMD11..	50030a	LA100..	55825a	LFB2250FG..	30360a	LFG2253FT..	30330a
KMD12..	50030a	LA100-SH..	55810a	LFB2250FT..	30325a	LFG2260FT-M..	30700a
KMD21..	50040a	LA110..	55600a	LFB2253RT..	30330a	LFG2351..	30745a
KMD22..	50040a	LA120E-02B..	55645a	LFB2253RTC..	30398a	LFG2351..VG	30755a
KMD23..	50040a	LA123H-02B..	55645a	LFB2256..	30730a	LFG2451TAB..	30750a
KMD24..	50080a	LA40..	55525a	LFB2256..VG	30735a	LFG2508FTS..	30620a
KMD25..	50080a	LA50..	55540a	LFG1700	11530a	LFG2551..	30745a
KMD26..	50080a	LA60..	55555a	LFG1702	11530a	LFG2630FTS..	30645a
KMD27..	50080a	LA60-01..	55630a	LFG1710..	11540a	LFG2651TAB..	30750a
KMD28..	50080a	LA60S-01..	55630a	LFG1710-CTAB..	11540a	LFG-COMB2500..	30615a
KMD31..	50040a	LA80..	55570a	LFG2120FG..	30070a	LFM30..	55750a
KMD32..	50040a	LA80H..	55570a	LFG2120FT..	30050a	LFM40..	55750a
KMD33..	50040a	LA80S..	55780a	LFG2120FT-PT..	30060b	LFM50..	55750a
KMD37..	50040a	LAF100SH-01..	55630a	LFG2120FT-PT.VG-2	30100d	NGE1400V..TAB	11600a
KMD39..	50060a	LAF123H..	55840a	LFG2120FT-PT.VG-3	30100d	LFW1400..	11590a
KMD40..	50060a	LAF123H-02B..	55660a	LFG2120FT-PT2..	30060b	LFW1400V..TAB	11600a
KMD41..	50060a	LAS100..	55615a	LFG2120FT-PT2..	30060b	LFW1431..	11590a
KMD42..	50060a	LAS120..	55615a	LFG2250FG..	30360a	LFW1700	11530a
KMD48..	50060a	LAS80..	55615a	LFG2260FG-M..	30700a	LFW1701-TAB	11530a
KMD52..	50060a	LAX100..	55810a	LFG2250FG-PT..	30360c	LFW1702	11530a
KMD61..	50050a	LAX102..	55795a	LFG2250FG-PT2..	30360c	LFW1710..	11540a
KMD62..	50050a	LAX123..	55840a	LFG2250FT..	30325a	LFW1710-CTAB..	11540a
KMD64..	50101a	LAX123-02B..	55660a	LFG2250FT..VG	30370a	LFW600..	11570a
KMD66..	50101a	LB100	55735a	LFG2250FT..VG-2	30370b	LFW600F	11580a
KMD68..	50070a	LB150	55735a	LFG2250FT..VG-3	30370b	LFW631 TAB	11580a
KMD71..	50070a	LB200	55735a	LFG2250FT..VGS	30380a	LMM120..	55720a
KMD78..	50070a	LB80	55735a	LFG2250FT..VGS-2	30380b	LMM80..	55720a
KMD82..	50070a	LF1700	11530a	LFG2250FT..VGS-3	30380b	LMP125..	55705a
KMD84..	50101a	LF1701-TAB	11530a	LFG2250FT-K330	30310a	LMP80..	55705a
KMD85..	50101a	LF1702	11530a	LFG2250FT-PT..	30335b	LMPH123..	55735a
KMD86..	50101a	LF1843 SS TAB..	11470a	LFG2250FT-PT..VG	30370d	LSHOE-S330	50600b
KMD87..	50101a	LF1843 TAB..	11470a	LFG2250FT-PT..VG-2	30370d	LSS100..	55675a
KMD90..	50091a	LF820..	11190a	LFG2250FT-PT..VG-3	30370d	LSS125..	55675a
KMD91..	50091a	LF820P..	11190a	LFG2250FT-PT2..	30335b	LSS50..	55675a
KMD92..	50091a	LF821..	11320a	LFG2250FT-PT2..	30335b	LSS75..	55675a
KMD93..	50091a	LF8257..	11310a	LFG2250FT-PT-K330	30310a	LSSC100..	55690a
KMD96..	50091a	LF828..	11210a	LFG2250FT-TAB..	30710a	LSSC125..	55690a
KMD97..	50101a	LF831..	11190a	LFG2251FT..	30440a	LSSC75..	55690a
KNF-30H21..	54610a	LF843..	11460a	LFG2251FT..VG	30490a	SNB2080..	30029a
KNF-40H26..	54610a	LF845..	11460a	LFG2251FT..VG-2	30490b	NB2120..	30175a
KNF-50H32..	54610a	LF877TAB..	11230a	LFG2251FT..VG-3	30490b	SNB2120..	30175a
KNF-50H39..	54600a	LF878TAB..	11230a	LFG2251FT..VGS	30495a	NGD1873TAB..VG	11420a
KNF-50H40..	54600a	LF879..	11240a	LFG2251FT..VGS-2	30495b	NGE1400..	11590a
KNF-50H41..	54600a	LF879P..	11240b	LFG2251FT..VGS-3	30495b	NGE1431..	11590a
		LF879M..	11220a	LFG2251FT-M..	30700a	NGE1700	11530a
				LFG2251FT-P.VG	30490c	NGE1701-TAB	11530a
				LFG2251FT-P.VG-2	30490c		

Legend

Codes ending with .. indicate a group of item descriptions all starting with the code listed. Example: 2122.. (all item descriptions starting with 2122).

Codes with .. in the middle indicate a group of item descriptions starting and ending with the codes listed. Example 2251..RS (all item descriptions starting with 2251 and ending with RS). **Information about item descriptions, printed in blue, is only available on our website: www.SystemPlastSmartGuide.com**

Chains & sprockets	Wear strips	Side guide brackets & accessories	Levelers	Engineering manual
Modular belts & sprockets	Chain & belt return systems	Frame & structure supports	Bearing supports	
Curves & tracks	Side guide solutions	Miscellaneous products	Equipment	

Item description	Page code	Item description	Page code	Item description	Page code	Item description	Page code
NGE1702	11530a	NGE2250FG-P2..	30360b	NGE880..	11240a	R-60..83-PEG	51080a
NGE1863 TAB..	11490a	NGE2250FG-P-K330	30340a	NGE8800..	11240b	R-60..85-PEB-S	51110a
NGE1863SS TAB..	11490a	NGE2250FG-PT..	30360c	NGE8800P..	11240b	R-60..85-PEG	51080a
NGE1873SS TAB..	11470a	NGE2250FG-PT..T	30350a	NGE880M..	11220a	R-9B4..	52680a
NGE1873SS TAB..GS	11440b	NGE2250FG-PT2..	30360c	NGE880TAB..	11230a	RF-11B4..	52680a
NGE1873SS TAB..GS..	11440a	NGE2250FT..	30325a	NGE880TAB..VAC43X2	11235a	RF-17B6..	52680a
NGE1873SS TAB..VG	11420a	NGE2250FT-K330	30310a	NGE882LBP TAB..	11360a	RF-21B6..	52680a
NGE1873SS TAB..VG85QH8.5	11425a	NGE2250FT-P..	30335a	NGE882LBP..	11360a	RF-24B6..	52680a
NGE1873TAB..	11470a	NGE2250FT-P2..	30335a	NGE882M..	11280a	RF-40..86-PEG	51080a
NGE1873TAB..GS	11440b	NGE2250FT-PT..	30335b	NGE882M..VG	11400a	RF-41..B	51020a
NGE1873TAB..GS..	11440a	NGE2250FT-PT..T	30320a	NGE882TAB..	11290a	RF-41..G	51060a
NGE1873TAB..VG	11420a	NGE2250FT-PT2..	30335b	NGE882TAB..VG	11400a	RF-47..G	51030a
NGE2080FT..	30025a	NGE2250FT-PT-K330	30310a	NGE-S-K38..	11330a	RF-50..28-PEG	51040a
NGE2120FG..	30070a	NGE2250FT-PT-K330T	30320a	PAB-COMB2500..	30615a	RF-50..43-PEG	51050a
NGE2120FG-P..	30075a	NGE2250FT-TAB..	30710a	PC-125110..	53640a	RF-50..86-PEG	51080a
NGE2120FG-P2..	30075a	NGE2251FT..	30440a	PC-25..	53610a	RF-50..B	51030a
NGE2120FG-PT..	30075b	NGE2251FT-K330	30420a	PC-25T..	54530a	RF-60..43-PEG	51050a
NGE2120FG-PT2..	30075b	NGE2251FT-M..	30700a	PC-30T..	54530a	RF-60..86-PEG	51080a
NGE2120FT..	30030a	NGE2251FT-PT..	30450b	PC-9075..	53635a	RF-60..G	51030a
NGE2120FT..	30050a	NGE2251FT-PT..T	30430a	PC-KIT	53640a	RG-105H..	52570a
NGE2120FT..GB	30120a	NGE2251FT-PT..TL	30430a	PC-KIT-0M	53605a	RG-105H49..3000A	52572a
NGE2120FT..GB-2	30120b	NGE2251FT-PT-K330	30420a	PC-KIT-19M	53605a	RG-105H49..3000S	52571a
NGE2120FT..GB-3	30120b	NGE2251FT-TAB..	30710a	PCO-H7816M-B	51690a	RG-105H49..348	52590a
NGE2120FT..VG50	30100a	NGE2251LBP..	30500a	PCO-H8716M-B	51700a	RG-105H52..3000S	52594a
NGE2120FT..VG50-2	30100b	NGE2251LBP-P..	30500b	PCO-H9014M-G	51680a	RG-105H81..3000A	52572a
NGE2120FT..VG50-3	30100b	NGE2252FT..	30445a	P-D..	51830a	RG-105H81..3000S	52571a
NGE2120FT..VGS50	30105a	NGE2252FT..	30420a	PE..	51830a	RG-165..	52520a
NGE2120FT-P..	30060a	NGE2252FT-PT..	30420a	PEN-H7816M-B	51690a	RG-210H50..	52570a
NGE2120FT-P..VG50	30100c	NGE2253FT..VAC43	30398n	PEN-H8716M-B	51700a	RG-210H50..3000A	52572a
NGE2120FT-P2..	30060a	NGE2260FT-M..	30700a	PEN-H9014M-G	51680a	RG-210H50..3000S	52571a
NGE2120FT-PT..	30030b	NGE600..	11570a	PF..	51830a	RG-240..	52521a
NGE2120FT-PT..	30060b	NGE820..	11190a	PG..	51830a	RG-240H45..3000S	52530a
NGE2120FT-PT..T	30045a	NGE820P..	11190a	PK-D12M110	51830a	RG-86H..	52570a
NGE2120FT-PT..VG50	30100d	NGE821..	11320a	PM10..	51830a	RG-86H49..3000A	52572a
NGE2120FT-PT2..	30060b	NGE821..VG	11410a	PMB..	54530a	RG-86H49..3000S	52571a
NGE2120LBP..	30110a	NGE821LBP..	11370a	PP1873SS TAB..GS..	11440b	RG-86H49..348	52590a
NGE2120M..	30720a	NGE8257..	11310a	PPW2502DT..	30617a	RG-86H81..3000A	52572a
NGE2121FT..	30030a	NGE8257..VG	11410a	PP878TAB..GS..	11430b	RG-86H81..3000S	52571a
NGE2121FT..	30055a	NGE8257LBP..	11370a	PPG2500RR..	30610a	RG-86H81..3000S	52571a
NGE2121FT-PT..	30030b	NGE828..	11210a	R-26..B	51020a	RG..	52550a
NGE2122FG..	30073a	NGE831..	11190a	R-26..G	51060a	RGC18-86H49..	52592a
NGE2124FT..	30030a	NGE831..VG	11380a	R-40..83-PEB-S	51110a	RGC20-105H49..	52592a
NGE2124FT..VG	30090a	NGE831LBP..	11340a	R-40..83-PEG	51080a	RGC32-86H49..	52593a
NGE2124FT-PT..	30030b	NGE863..	11460a	R-40..85-PEG	51080a	RGC33-105H49..	52593a
NGE2124FT-PT..VG	30090a	NGE877TAB..	11230a	R-41..B	51020a	RH-45..	54620a
NGE2190FG..	30230a	NGE878LBP..	11350a	R-41..G	51060a	RH-65..	54620a
NGE2190FG..	30220a	NGE878TAB..	11230a	R-49..G	51040a	RH-80..	54620a
NGE2190FG-PT..	30220a	NGE878TAB..GS..	11430b	R-50..27-PEG	51040a	RPAD10004	55810a
NGE2190FT..	30210a	NGE878TAB..GS..	11430a	R-50..41-PEG	51050a	RPAD10108	55600a
NGE2190FT..	30200a	NGE878TAB..VG	11390a	R-50..43-PEG	51050a	RPAD11207	55615a
NGE2190FT-PT..	30200a	NGE879..	11240a	R-50..83-PEB-S	51110a	RPAD11207	55645a
NGE2190FT-PT..T	30215a	NGE879LBP TAB..	11350a	R-50..83-PEG	51080a	RPAD12208	55660a
NGE2250FG..	30360a	NGE879M..	11220a	R-50..85-PEB-S	51110a	RPAD12208	55645a
NGE2250FG-K330	30340a	NGE879M..VG	11380a	R-50..85-PEG	51080a	RPAD12208	55840a
NGE2260FG-M..	30700a	NGE879TAB..	11230a	R-60..41-PEG	51050a	RPAD12506	55705a
NGE2250FG-P..	30360b	NGE879TAB..VG	11390a	R-60..83-PEB-S	51110a	RPAD12506	55720a

Legend

Codes ending with .. indicate a group of item descriptions all starting with the code listed. Example: 2122.. (all item descriptions starting with 2122).

Codes with .. in the middle indicate a group of item descriptions starting and ending with the codes listed. Example 2251..RS (all item descriptions starting with 2251 and ending with RS). **Information about item descriptions, printed in blue, is only available on our website: www.SystemPlastSmartGuide.com**

Chains & sprockets	Wear strips	Side guide brackets & accessories	Levelers	Engineering manual
Modular belts & sprockets	Chain & belt return systems	Frame & structure supports	Bearing supports	
Curves & tracks	Side guide solutions	Miscellaneous products	Equipment	

Item description	Page code	Item description	Page code	Item description	Page code	Item description	Page code
RPAD3206	55525a	SP-10944T15	53545a	TCHD-R150-R150-S	54080a	TTM87..	50101a
RPAD4206	55540a	SP-11253T15	53545a	TC-R150-S	54080a	TTM90..	50091a
RPAD5207	55630a	SP-7550..	53515a	TEE..	54080a	TTM91..	50091a
RPAD5306	55555a	SP-R36T..	53535a	TEE-3815-BM10	54080a	TTM92..	50091a
RPAD7207	55615a	SPSL815..	11020a	TEE-4415-BM10	54080a	TTM93..	50091a
RPAD7207	55570a	SPSL881MO..	11060a	TEE-4815-BM10	54080a	TTM96..	50091a
RPAD8006	55705a	SPT-10..	51160a	TE-R..	55765a	TTM97..	50101a
RPAD8006	55720a	SPT-11L..	51130a	TE-S..	55765a	TTMK..	50565a
RPAD9308	55585a	SPT-15..	51150a	TME..	52670a	TUBE-R10S-6000	53605a
RPAD9308	55795a	SPT-16..	51160a	TME-K..	52671a	TWP-S4030..	55765c
RPAD9308	55615a	SPT-2..	51130a	TOP-20P	53585a	UC..	56300a
RPAD9308	55825a	SPT-4..	51130a	TOP-23P..	53585a	UCFB..	56140a
RR-47..83-PEB-S	51110a	SPT-4..	51160a	TOP-23S..	53585a	UCFG..	56080a
RR-47..83-PEG	51080a	SPT-84..	51120a	TOP-24P..	53585a	UCFH..	56020a
RR-47..85-PEB-S	51110a	SPT-84..	51160a	TOP-24S..	53585a	UCFH..	56030a
RR-47..85-PEG	51080a	SQL..	56130a	TOP-25S..	53585a	UCFH..	56042a
RR-57..27-PEG	51040a	SR800..	11120a	TOP-40P..	53585a	UCFH..ME..	56040a
RR-57..41-PEG	51050a	SS802..	11120a	TOP-40S..	53585a	UCFHXX..	56042a
RR-57..43-PEG	51050a	SS812..	11030a	TOP-60S..	53585a	UCFL..	56020a
RR-57..83-PEB-S	51110a	SS881M..	11060a	TOP-90S..	53585a	UCFL..ME..	56040a
RR-57..83-PEG	51080a	SS881MO..	11060a	TTM01..	50050a	UFLX..	56020a
RR-57..85-PEB-S	51110a	SSA805..	11120a	TTM02..	50050a	UFLQ..	56072a
RR-57..85-PEG	51080a	SSA815..	11030b	TTM03..	50020a	UFLZ..ME..	56040a
RR-67..41-PEG	51050a	SSA8810..	11080a	TTM04..	50050a	VG-009M-01	51630a
RR-67..83-PEB-S	51110a	SSA8810TAB..	11070a	TTM05..	50030a	VG-011..	51620a
RR-67..83-PEG	51080a	SSE515..	11130a	TTM06..	50020a	VG-012-01	51620a
RR-67..85-PEB-S	51110a	SSE805..	11120a	TTM07..	50020a	VG-013..	51620a
RR-67..85-PEG	51080a	SSE805..VG	11180a	TTM08..	50020a	VG-016-02	51630a
RRF-40..86-PEG	51080a	SSE815..	11030a	TTM09..	50020a	VG-018M..	51630a
RRF-50..86-PEG	51080a	SSE8157..	11100a	TTM10..	50020a	VG-022-01	51630a
RRF-57..28-PEG	51040a	SSE8157..VG	11180a	TTM11..	50030a	VG-113SM-08G	51820a
RRF-57..43-PEG	51050a	SSE8157TAB..VG	11180a	TTM12..	50030a	VG-1568M..	52611a
RRF-60..86-PEG	51080a	SSE8810..	11080a	TTM21..	50040a	VG-213..	53565a
RRF-67..43-PEG	51050a	SSE881..VG	11170a	TTM22..	50040a	VG-213R-TOP..	53590a
RSHOE-S330	50600b	SSE881M..	11060a	TTM23..	50040a	VG-222JO..	51810a
S800..	11030b	SSE881MO..	11060a	TTM31..	50040a	VG-223R..	53565a
S815..	11030b	SSE881MO..	11160a	TTM32..	50040a	VG-223R-TOP..	53590a
SCREW21M5-SS	30615a	SSE8810..	11080a	TTM33..	50040a	VG-245..	53575a
SF-CD1..	54540a	SSE8810TAB..	11070a	TTM37	50040a	VG-253..	53570a
SF-SPS..	54540a	SS8810TAB..	11070a	TTM39..	50060a	VG-254..	53570a
SHOE-15L105..	51150a	SSE881RTAB..	11070a	TTM40..	50060a	VG-3050..	54020a
SHOE-48..	52611a	SSE881TAB..VG	11170a	TTM41..	50060a	VG-3051..	54050a
SHOE-49L26	52592a	SSE8857M..	11110a	TTM42..	50060a	VG-3052..	54050a
SHOE-49L42	52593a	SSE8857M..VG	11160a	TTM48..	50060a	VG-3055..	54050a
SHOE-53L102..	51150a	SSE8857TAB..	11110a	TTM52..	50060a	VG-3070..	54060a
SHOE-84L244..	51170a	SSEL815..	11020a	TTM61..	50050a	VG-3080..	54060a
SHOE-84L68..	51160a	SSEL815..	11030a	TTM62..	50050a	VG-3087..	54060a
SHOE-85L244..	51170a	SSEL881MO..	11060a	TTM64..	50101a	VG-3110..	54070a
SHOE-88L244..	51170a	SSER814..VG	11150a	TTM66..	50101a	VG-3115..	54070a
SHOE-89L152..	51170a	SSER815..VG	11150a	TTM68..	50070a	VG-60..	53615a
SHOE-94..	52611a	SSER815TAB..VG	11150a	TTM71..	50070a	VG-619..	53610a
SK38..DMS	11330a	SSL812..	11030a	TTM78..	50070a	VG-620..	53615a
SK38..RMS	11330a	SSL881MO..	11060a	TTM82..	50070a	VG-632..	54560a
SMB-60..	53625a	SSSR815..	11030a	TTM84..	50101a	VG-633..	54550a
SP-10049..	53535a	TC-20..	53610a	TTM85..	50101a	VG-634..	54550a
		TC-60..	53625a	TTM86..	50101a	VG-641T..	53590a

Legend

Codes ending with .. indicate a group of item descriptions all starting with the code listed. Example: 2122.. (all item descriptions starting with 2122).

Codes with .. in the middle indicate a group of item descriptions starting and ending with the codes listed. Example 2251..RS (all item descriptions starting with 2251 and ending with RS). **Information about item descriptions, printed in blue, is only available on our website: www.SystemPlastSmartGuide.com**

Chains & sprockets	Wear strips	Side guide brackets & accessories	Levelers	Engineering manual
Modular belts & sprockets	Chain & belt return systems	Frame & structure supports	Bearing supports	
Curves & tracks	Side guide solutions	Miscellaneous products	Equipment	

Item description	Page code	Item description	Page code	Item description	Page code	Item description	Page code
VG-686A-1.25-3M	52611a	VG-JSL075-125..	50530a	VG-Q-75-40..	53595a		
VG-687-1.4-3M	52612a	VG-JSL075-188..	50530b	VG-QSC..	53595a		
VG-687-3.3-3M	52612a	VG-L20M..	50520a	VG-QT-01	53595a		
VG-687FLEX-1.4-3M	52610a	VG-LGSF..	51520a	VG-S1020M..	51660b		
VG-687H-1.4-3M	52611a	VG-LGSR..	51520a	VG-S1040M..	50560a		
VG-687H-3.3-3M	52611a	VG-LGST..	51520b	VG-S330M..	50580a		
VG-687LDB-M8	52612a	VG-LSSF..	51520a	VG-S4-330M..	50580a		
VG-687NP-1.4M	52612a	VG-LSSM..	51520a	VG-S4P330C..	50580b		
VG-687SP	52611a	VG-LSSMT..	51520c	VG-S4-S3020..	50550a		
VG-688-1.4-3M	52614a	VG-LSSR..	51520a	VG-S640M..	50560a		
VG-688-3.3-3M	52614a	VG-LSST..	51520b	VG-S840M..	50560a		
VG-688FLEX-1.4-3M	52610a	VG-LSST..	51520a	VG-SC..	54630a		
VG-688H-1.4-3M	52613a	VG-LSST..	51520c	VG-SCL..	54630a		
VG-688H-3.3-3M	52613a	VG-LSSWF..	51520a	VG-SD..	51660a		
VG-750-10	50550b	VG-LSSWF..	51520b	VG-SP1040M..	50560a		
VG-A2520..	51740b	VG-MBG-50-NS-10	50570a	VG-SP330C..	50580b		
VG-A330M..	50580a	VG-NG110..	51720a	VG-SP640M..	50560a		
VG-A600A..	51740a	VG-NG125..	51720a	VG-SP840M..	50560a		
VG-A840..	52650a	VG-NG47..	51720a	VG-SSF-HT-10	51520a		
VG-ABG..	51730a	VG-NG49..	51720a	VG-SSMT..	51520c		
VG-AP330C..	50580b	VG-NG50..	51720a	VG-SSTS..	51520b		
VG-BP..	54030a	VG-NG81..	51720a	VG-T425M..	50550b		
VG-BPT..	54030b	VG-NG91..	51720a	VG-TP..	54030a		
VG-BPV..	54030b	VG-P1040M..	50560a	VG-U3041..	50550a		
VG-BWS-125-10	50570a	VG-P105..	50650a	VG-U3042..	50550a		
VG-DB83M-B-10	51710a	VG-P10MRD..	51710a	VG-U3043..	50550a		
VG-F203M..	50550b	VG-P12MRD..	51710a	VG-U4045..	50550a		
VG-F205M..	50550b	VG-P14BC..	50650a	VG-J23..	50520a		
VG-F205M..	51120a	VG-P14HD..	50650b	VG-Z18M..	50520a		
VG-F206M..	51120a	VG-P18BC..	50650a	VG-Z20M..	50520a		
VG-F253M..	50550b	VG-P18CC-100	50530a	VG-Z20WM..	50520a		
VG-F303M..	50550b	VG-P18HD..	50650b	VG-Z21..	50520a		
VG-F403..	50550a	VG-P2520..	51740b	VT1701T..	50170a		
VG-F403M..	50550b	VG-P316BC..	50650a	VT1710CT..	50170a		
VG-F503M..	50550b	VG-P316HD..	50650b	VT1713CT..	50180a		
VG-F603M..	50550b	VG-P330C..	50580a	VT1873T..	50160a		
VG-F703M..	50550b	VG-P330CW..	50610a	VT880B..	50130a		
VG-G1020M..	51660b	VG-P330M..	50560a	VT880T..	50110a		
VG-GD..	51660a	VG-P516BC..	50650b	VT882..	50140a		
VG-H7816M..	51690a	VG-P640M..	50560a	VT882B..	50150a		
VG-H14022M..	51703a	VG-P650M..	50560a	VTC880..	50120a		
VG-H8716M..	51700a	VG-P680M..	50560a	VTR880B..	50130a		
VG-H9014M..	51680a	VG-P7GABC..	50650a	VTR882B..	50150a		
VG-J100-125T..	50530a	VG-P7GAHD..	50650b	W1700	11530a		
VG-J100-188..	50530b	VG-P813..	51740a				
VG-J21M..	50520a	VG-P816..	51740a				
VG-J23M..	50520a	VG-P822..	51740a				
VG-JEL-078..	50530a	VG-P834..	51740a				
VG-JL19M..	50520a	VG-P840DBM..	51710a				
VG-JS100-125..	50530a	VG-P840M..	50560a				
VG-JS100-188..	50530b	VG-P8MRD..	51710a				
VG-JS150-125..	50530a	VG-PBG5..	51730a				
VG-JS150-18..	50530b	VG-PBG7..	51730a				
VG-JS200-125..	50530a	VG-PD..	51660b				
VG-JS200-188..	50530b	VG-PM10BC..	50650b				
VG-JS3-075-125..	50530a	VG-PM4BC..	50650a				

Legend

Codes ending with .. indicate a group of item descriptions all starting with the code listed. Example: 2122.. (all item descriptions starting with 2122).
 Codes with .. in the middle indicate a group of item descriptions starting and ending with the codes listed. Example 2251..RS (all item descriptions starting with 2251 and ending with RS). **Information about item descriptions, printed in blue, is only available on our website: www.SystemPlastSmartGuide.com**