

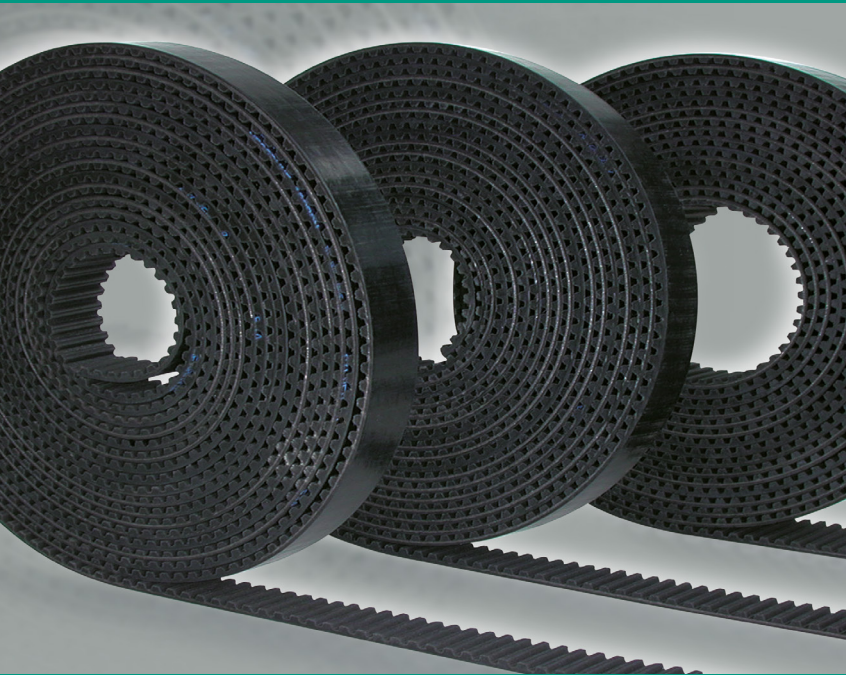

MEGADYNE



RUBBER OPEN ENDED

TECHNICAL
HANDBOOK

EN

INDEX

Introduction to rubber open-ended belts	2
Classifications	3
Technical calculation	5
Calculation example	8
Calculation parameters	10
Belt installation and feasibility table	11
Belt failures	13
Belt data	
MXL	14
XL	16
L	18
H	20
RPP3	22
RPP5	24
RPP8	26
RPP8 steel cords	28
RPP14 steel cords	30
SILVER3 3M	32
SILVER3 5M	34
SILVER3 8M	36
TITANIUM 8M	38
TITANIUM 14M	40
STD8	42
Special execution feasibility	44
Clamping plates	45
Useful formulas and conversion table	46
Data sheet	47



INTRODUCTION TO

RUBBER OPEN-ENDED BELTS

Megadyne rubber open-ended belts are rubber based timing belts manufactured with high quality materials and state of the art production process. As a result of this Megadyne offers belts which have been designed to respond to the high demands of today's industrial market.

Megadyne rubber open-ended belts are specially suitable for reversing drives and applications when rotational movements need to be transformed into linear motion and high positioning accuracy is required.

Megadyne rubber open-ended belts are a great solution when substituting expensive conventional linear systems. Noise level improvement will be obtained as well as economic benefits due to the reduction of the initial investment and the maintenance costs.

Taking into account the advantages and the available product range, these belts can be considered as a solution for a very wide field of applications in industrial equipment. Few examples of typical applications can be:

- Automatic doors for garage
- Automatic sliding doors
- X-Y tables on tooling machines
- Level control on elevators
- Fitness machines
- Printers
- Linear positioning systems

STANDARD RANGE

MXL • XL • L • H

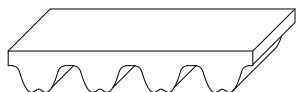
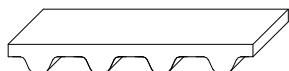

RPP3 • RPP5 • RPP8 • RPP14 • SILVER3 3M • SILVER3 5M • SILVER3 8M
• TITANIUM 8M • TITANIUM 14M
(SILVER3 14M • GOLD2 5M • GOLD2 8M • GOLD2 14M on demand)

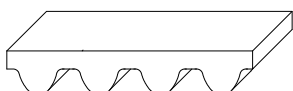

STD8

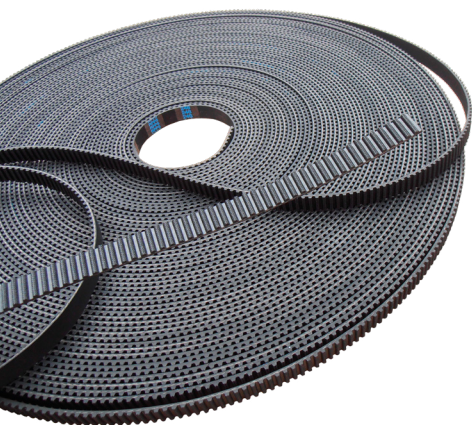

RUBBER OPEN-ENDED

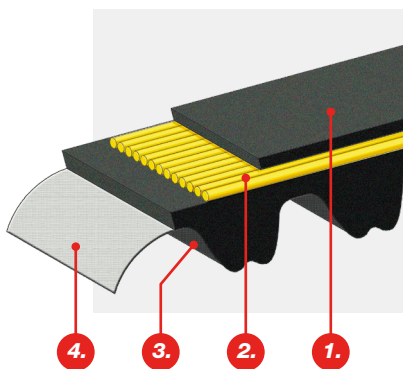

CLASSIFICATIONS

CLASSIFICATIONS

Megadyne rubber open-ended belts are manufactured in rubber compound. They come from sleeves for spiral cut belts and from press for straight cut belts.

The belt is made by:

1. BELT BACK

The back side cushion protects the tensile member and permits the use of backside idlers thanks to its elasticity.

2. TENSION MEMBERS

Fiberglass, steel or carbon cords of the latest technology grant the longitudinal rigidity and resistance of the belt.

3. BELT BODY

The belt body is made of special polychloroprene-based, nitrile-based, HNBR or EPDM rubber compound. These compounds guarantee the highest tooth shear resistance.

4. FABRIC

Hard wearing nylon fabric is bonded on tooth surface to improve torque carrying capacity. In addition a special coating gives self-lubricating action and increases drive efficiency.

BELT CONSTRUCTION

The advantages of Megadyne rubber open-ended belts are:

- High positioning accuracy on reverse drives.
- To cover a wide range of applications.
- Low noise level due to vibration absorbing characteristic of rubber.
- Low operation costs due to free of maintenance and long lasting service life.
- Compact and light drives are feasible due to high specific belt performance.

MECHANICAL AND CHEMICAL CHARACTERISTICS

- Constant dimensions
- Noiseless
- Maintenance-free
- High flexibility with fiberglass cords
- Linear speed up to 50 m/s
- Low pretension
- Constant length
- High abrasion resistance
- Standard working temperature -25 /+80 °C;
for TITANIUM: -40/+120°C

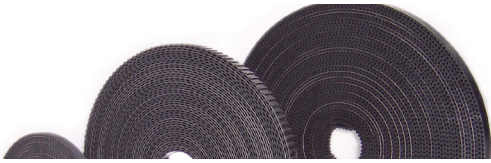

CLASSIFICATIONS

BODY

Megadyne rubber open-ended belts are manufactured with polychloroprene compound. Special compounds (different hardness, special properties) are available on request. See below for compound characteristics:

RESISTANCE TO	STANDARD BELT RESISTANCE
Mineral oils	LOW
Water	MEDIUM
Acids / Alkalis	NONE
Solvents	NONE
Oils	LOW
Greases	MEDIUM
Fuels	NONE
Environment agents	MEDIUM

TEMPERATURE

Min T (°C)	-25; -40 (TITANIUM)
Max T (°C)	80; +120 (TITANIUM)
Max peak T (°C)	100; +140 (TITANIUM)

IDENTIFICATION CODE

Using the information in the table below, it is possible to identify the correct belt for every application.

The code is composed of letters and numbers as the following example:

1		2
H	+	200
RPP5	+	15
SILVER3 8M	+	25

1. This code composed by letters and numbers indicates the selection of tooth pitch and tooth profile.
2. This number indicates the width of the requested belts. The value is in mm for belts with metric pitch and in inches for belts with imperial pitch.

TECHNICAL CALCULATION

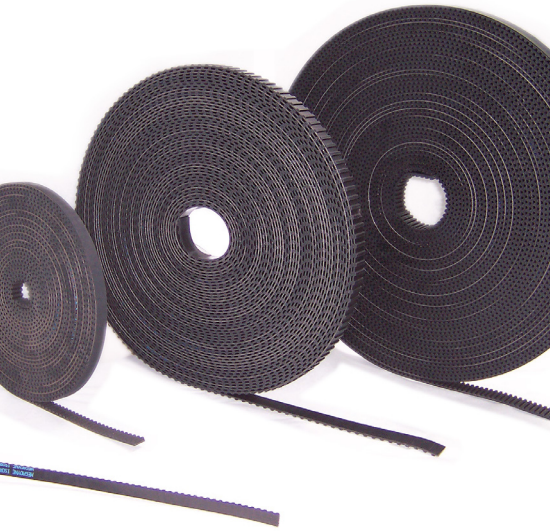

LINEAR MOTION BELT

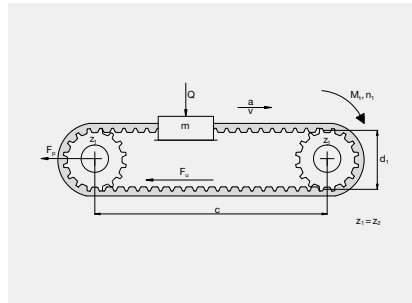

OMEGA LINEAR MOTION BELT

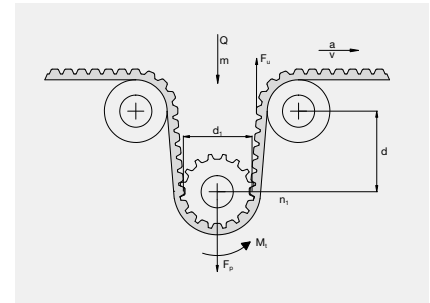

The following pages contain data, formulae and tables that are required to design a new belt drive.

For critical and difficult drives, it is recommended that you contact our Application Department for advice.

SYMBOL	UNIT	DEFINITION
b	mm	belt width
L	mm	belt length
c	mm	centre distance
d_i	mm	pitch diameter of pulley i
m	kg	total conveyed mass
a	m/s ²	acceleration
v	m/s	belt speed
C_s	-	safety factor
g	m/s ²	gravity (9.81)
μ	-	coefficient of friction ⁽¹⁾
p	-	belt pitch
MTL	N	Max Traction Load
F_p	N	pretension
F_u	N	peripheral force
F_{p spec}	N/cm	transmittable force per tooth per unit
M_t	Nm	drive torque
n₁	1/min	revs/min (RPM)
P	kW	drive power
Q	N	force exerted by mass (m)
z₁		number of teeth on pulley i
z_m		number of teeth in mesh on driver pulley
z_s		number of teeth on small pulley
z_L		number of teeth on largest pulley
BS	N	Breaking Strength

Max Traction Load is maximum acceptable traction on cords

Breaking Strength is necessary load to break belt cord

⁽¹⁾ Between the belt and the guide

USEFUL FORMULAE AND CONVERSION FACTORS

$$V = \frac{d_1 \cdot n_1}{19100} \quad n_1 = \frac{V \cdot 19100}{d_1} \quad d_1 = \frac{V \cdot 19100}{n_1} \quad Q = m \cdot g$$

$$P = \frac{M_t \cdot n_1}{9550} \quad M_t = \frac{9550 \cdot P}{n_1} \quad M_t = \frac{F_u \cdot d_1}{2000}$$

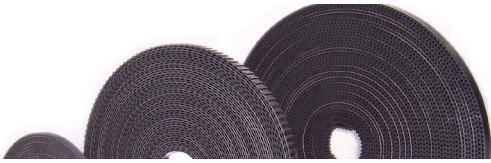

TECHNICAL CALCULATION

CALCULATION OF THE PERIPHERAL FORCE ON THE TIMING BELT

Knowing mass	For horizontal & conveying drives	$F_u = (m \cdot a) + (m \cdot g \cdot \mu)$
	For vertical drives	$F_u = (m \cdot a) + (m \cdot g)$
Knowing drive torque	-	$F_u = 2000 M_t / d_1$
Knowing drive power	-	$F_u = 19.1 \cdot 10^6 \cdot P / (d_1 \cdot n_1)$

BELT WIDTH AND PROFILE ESTIMATION

With the result of F_u select the belt type profile and approximate the belt width according to DIAGRAM 1 page 10 on "Belt width selection".

CHOICE OF PULLEYS

Choose the closest standard pulley according to the data sheet of each belt type

$$z = \frac{\pi \cdot d_1}{p}$$

$$n_1 = \frac{6000 \cdot v}{p \cdot z_1}$$

Always verify that the chosen z is higher or equal to z_{min} written in belt data pages.

DETERMINATION OF BELT WIDTH

The belt width b should be calculated using the following formula

$$b = \frac{F_u \cdot F_s \cdot 10}{F_{p, spec} \cdot z_m}$$

where:

- F_u from above calculation.
- F_s is the service factor from page 10.
- $F_{p, spec}$ is the transmittable force per tooth per cm, from belt data pages.
- z_m is the number of teeth in mesh on driver pulley, that you can calculate as per below:

$$z_m = \left\{ 0,5 - \left[\frac{4 p}{79 c} \cdot (z_1 - z_s) \right] \right\} \cdot z_s$$

This value z_m can't be higher than 12.

From the calculated width b , choose the next higher available width; you can check available widths in belt data page.

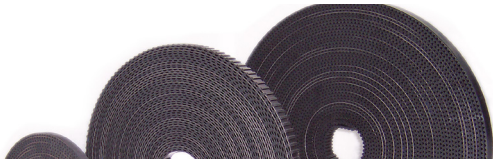

TECHNICAL CALCULATION

PRE-TENSIONING

The suggested installation tension is $F_p = F_u \cdot 1,2$

MESHING CHECK

In order to guarantee the correct function of the drive check the safety factor against break as per below:

$$\sigma_{BS} = \frac{BS}{F_u + \frac{F_p}{2}}$$

where:

- BS is the Breaking Strength (see tables on belt data pages)
- F_u from above calculation
- F_p is the tension, from above calculation

The σ_{BS} outcoming value has to be higher than 11 for fiberglass and 8 for steel cords. If it is lower, please retry with the next wider belts till you will get a value higher than 11 or 8.

ELONGATION

You can find belt elongation from Belt Elongation diagrams in belt data pages at Load equal to $F_p/2$ using the formula:

$$\Delta_{100} = \frac{\text{Belt's Max Elongation} \cdot F_p/2}{BS}$$

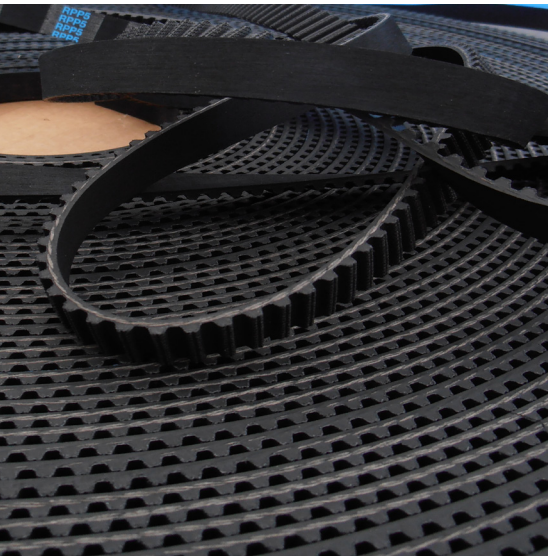

CALCULATION EXAMPLE

CALCULATION EXAMPLE

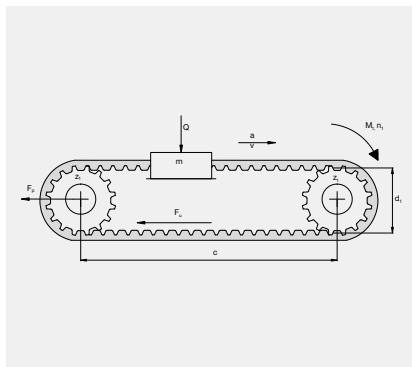

Type of application	Automatic door
Type of load	Low fluctuation load
Hours of daily service	12 hours
Desired pulley pitch diameter	d₁ = 38,2 mm
Centre distance	c = 3m
Mass to carry	m = 100 kg
Coefficient of friction	μ = 0,3
Speed	v = 1,5 m/s
Acceleration	a = 1,5 m/s²
Deceleration	a_b = 1,5 m/s²

CALCULATION OF THE PERIPHERAL FORCE ON THE TIMING BELT

Since the mass is known, F_u can be calculated:

$$F_u = m \cdot a + m \cdot g \cdot \mu = 100 \cdot 1,5 + 100 \cdot 9,8 \cdot 0,3 = 444 \text{ N}$$

BELT WIDTH AND PROFILE ESTIMATION

With the result of F_u select the belt type profile and approximate the belt width according to DIAGRAM 1 page 10 on "Belt width selection". The first estimation is for a RPP5M15.

CHOICE OF PULLEYS

Knowing the pitch diameter

$$z_1 = \frac{\pi \cdot d_1}{p} = \frac{\pi \cdot 38,2}{5} = 24 > 14$$

where 14 is z_{\min} as per belt data page.

Always verify that the chosen z is higher or equal to z_{\min} written in belt data pages.

Knowing the linear speed

$$n_1 = \frac{6000 \cdot v}{p \cdot z_1} = \frac{6000 \cdot 1,5}{5 \cdot 24} = 750 \text{ rpm}$$

DETERMINATION OF BELT WIDTH

To calculate the belt width b we need to find out the service factor F_s first:

$$F_s = \frac{F_1 + F_3 + F_4}{F_2} = \frac{1,4 + 0 + 0}{1} = 1,4$$

CALCULATION EXAMPLE

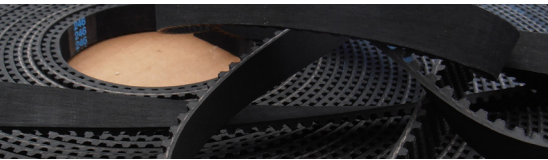

where:

- F1, from table page 10, according to input data
- F2 = 1 because $z_m = \frac{z_1}{2} = \frac{24}{2} = 12$
- F3 = 0 because $n_2 / n_1 = 1$
- F4 = 0 because no reverse bending

Then, the belt width b should be calculated using the following formula

$$b = \frac{F_u \cdot F_s \cdot 10}{F_{p, spec} \cdot z_m} = \frac{444 \cdot 1,4 \cdot 10}{28,5 \cdot 12} = 12,17 \text{ mm}$$

We will choose the next higher available width: $20 > 18,7$

PRE-TENSIONING

The suggested installation tension is $F_p = 2 F_u = 2 \cdot 444 = 888 \text{ N}$

MESHING CHECK

$$\sigma_{BS} = \frac{BS}{F_u + \frac{F_p}{2}} = \frac{7780}{444 + \frac{888}{2}} = 8,76$$

This value is lower than 11, that is the required minimum. Because of this you should check with the next wider available belt, that is 25 mm. This is the correct width as demonstrated by below calculation

$$\sigma_{BS} = \frac{BS}{F_u + \frac{F_p}{2}} = \frac{11150}{444 + \frac{888}{2}} = 12,55$$

where 11150 is the BS for a RPP5M25.

ELONGATION

From Belt Elongation diagram at page 24 we will find:

$$\Delta l/00 = \frac{\text{Belt's Max Elongation} \cdot \frac{F_p}{2}}{BS} = \frac{3,00 \cdot 444}{11150} = 0,12 \text{ mm}$$

where Max Elongation is for the elongation of the specific length at BS.

FINAL SELECTION

The selected belt is RPP5M25.

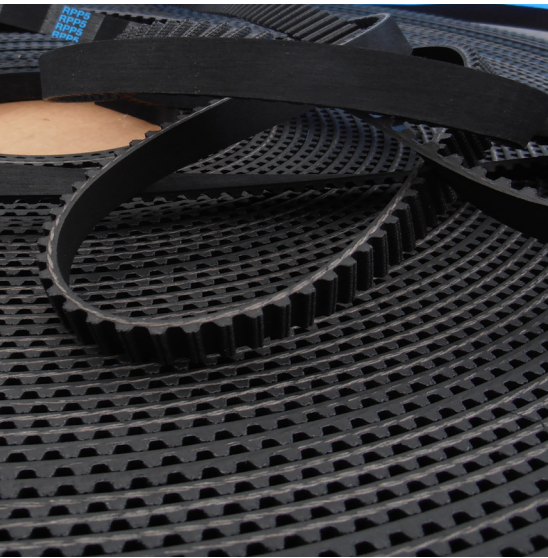

CALCULATION PARAMETERS

$$F_s = \frac{F_1 + F_3 + F_4}{F_2}$$

F_s : **Service Factor**

F_1 : **Load Factor**

F_2 : **Teeth in mesh Factor**

F_3 : **Ratio Factor**

F_4 : **Reverse Bending Factor**

LOAD FACTOR (F_1)

UNIFORM LOAD	1,0		
	DAILY SERVICE IN HOURS		
	3-8 HOURS	8-16 HOURS	16-24 HOURS
With low peak load	1,2	1,4	1,6
With high peak load	1,5	1,7	1,9
With very high peak load	1,8	2,0	2,2

TEETH IN MESH FACTOR (F_2)

TEETH IN MESH	F_2
12	1,0
10	0,8
8	0,6
6	0,4

RATIO FACTOR (F_3)

SPEED RATIOS	F_3
1 / 1,24	0
1,25 / 1,74	0,10
1,75 / 2,49	0,20
2,50 / 3,49	0,30
3,50 and above	0,40

REVERSE BENDING FACTOR (F_4) - with reverse by back idler

F_4
0,2



BELT INSTALLATION

AND FEASIBILITY TABLE

PROCEDURE TO MEASURE

The preferred procedure to measure the tension of the belt is to use a Belt Tension Meter. This device consists of a small sensing head which is held across the belt to be measured. The belt is then tapped to induce the belt to vibrate at its natural frequency. The vibrations are detected by the sensing head and the frequency of vibration is displayed on the measuring unit. The relation between belt static tension (T_s) and frequency of vibration (f) may be calculated using the following formula:

$$f = \frac{1}{2t} \cdot \sqrt{\frac{T_s}{m}} \quad \text{or} \quad T_s = 4 \cdot m \cdot t^2 \cdot f^2$$

where:

T_s = static tension (N)	f = Frequency of vibration in Hertz (Hz)
m = Belt mass per unit length (kg/m)	t = Free belt span length in meters (m)

BELT AND PULLEY ALIGNMENT

For a correctly functioning system and to increase belt life, proper pulley installation is necessary: pulleys have to be parallel and aligned as shown in drawing 1 (correct configuration).

If pulleys are not parallel as in drawing 2, belt could fall causing damage to the entire equipment.

To ensure correct belt function α and Δx must be as small as possible. For more information, please contact our technical staff.

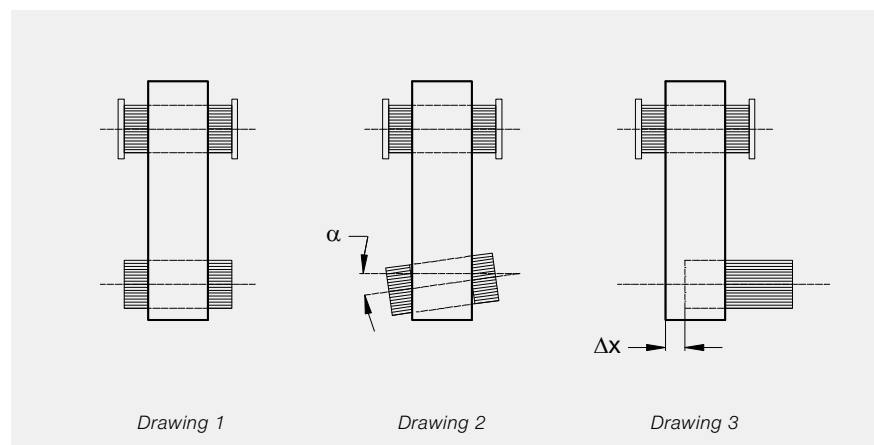

Drawing 1

Drawing 2

Drawing 3

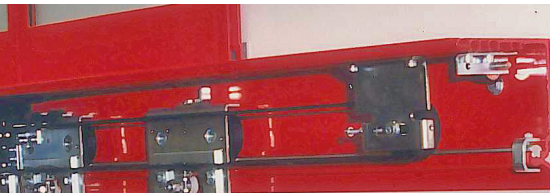

BELT INSTALLATION

AND FEASIBILITY TABLE

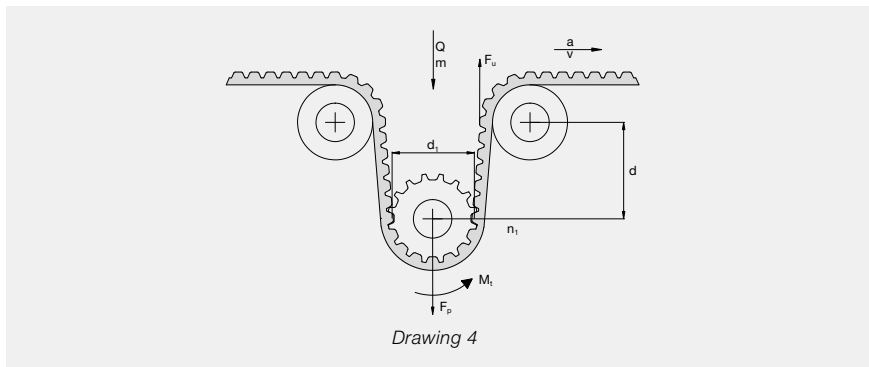

In omega applications to ensure good mesh between pulley and belt teeth and to respect belt flexibility avoiding excessive stress on cords, distance d (as drawing 4) has to be:

$$d = 4 \cdot \text{belt width} \quad \blacktriangleright \quad \text{Suggested angle } 120^\circ$$

FEASIBILITY TABLE

Megadyne manufactures a wide range of rubber open-ended belts. In the next table a general overview is shown of the current range of products and their main characteristics. For any special belt version which might not be included, please do not hesitate to contact our Application Engineering Department or check page “Special Execution Feasibility”.

Please consider that special versions might have different performance from what is declared in standard belt data pages.

FEASIBILITY TABLE														
	IMPERIAL PROFILE				PARABOLIC PROFILE									STANDARD PROFILE
	MXL	XL	L	H	RPP 3M	RPP 5M	RPP 8M	RPP 14M	SLV3 3M	SLV3 5M	SLV3 8M	TTM 8M	TTM 14M	STD 8M
Standard	S	S	S	P	S	P	P	P	S	S	S	S	S	S

P = Ex stock (production process: Straight cut)
S = Ex stock (production process: Spiral cut)

MEGADYNE RUBBER OPEN-ENDED - BELT FAILURES

	PROBLEMS	CAUSES	CORRECTION ACTION
EXCESSIVE BELT WEAR	Unexpected wear along the complete tooth width.	Belt overload.	Use a wider belt. Use a belt of a higher performance class.
	Unexpected wear on one side of the tooth only.	Incorrect pulley execution. Incorrect pulley alignment.	Control pulley dimensions and replace if necessary. Control and adjust pulley alignment.
	Tooth bottom shows wear.	Excessive belt installation tension. Incorrect pulley execution.	Calculate and adjust the belt tension. Control pulley dimensions and replace if necessary.
	Tooth root shows signs of wear.	Incorrect diameter of pulley.	Control pulley dimensions and replace if necessary.
	The flanks of the belt show clear signs of wear.	Incorrect pulley execution.	Control pulley dimensions and replace if necessary.
		Misalignment or wrong setting of pulleys.	Control pulley dimensions and replace if necessary.
		Oscillation of the axes and/or of the bearings.	Correct the positioning of the pulleys and reinforce the bearings.
Damaged belt tensile member.	Diameter of pulley is below specified minimum.	Increase the diameter of the pulleys or use belts and pulleys of smaller pitch.	
	Excessive moisture.	Eliminate the moisture.	
BELT DAMAGES	Torn tooth along the belt.	Too few teeth in mesh on the motor pulley.	Increase the number of teeth in mesh by using a bigger pulley. Use a belt of a higher performance class. Increase belt width.
		Belt overload.	Use a belt of a higher performance class or increase belt width.
		Incorrect pulley execution.	Control pulley dimensions and replace if necessary.
	Rupture of tensile member.	Belt overload.	Use a belt of a higher performance class or increase belt width.
		Diameter of pulley is below specified minimum.	Increase the diameter of the pulleys
		Tooth jump due to missing belt installation tension.	Calculate and adjust the belt tension.
	Breaks or cracks in the back side of the belt.	Exposure to temperatures which are out of the admissible temperature range.	Protect the transmission by extreme temperatures.
		Diameter of pulley is below specified minimum.	Increase the diameter of the pulleys.
		Excessive exposure to UV radiation.	Reduce exposure to UV radiation.
	Softening of the top surface of the belt.	Operation with excessive amount of oil.	Protect the belt from oil.
Apparent elongation of the belt.	Reduction of centre distance due to bearings not being firmly fixed.	Restore the initial centre distance and strengthen the bearings.	
DRIVE FUNCTION PROBLEMS	Belt overriding the pulley flanks.	Faulty installation of the flanks.	Reinstall the flanks properly.
		Misalignment of pulleys.	Align pulleys.
	Excessive wear on the pulley teeth.	Excessive overloading.	Use a wider belt.
		Excessive belt installation tension.	Calculate and adjust the belt tension.
		Pulley material insufficient hard.	Harden the pulley surface.
	Drive excessively noisy.	Pulleys out of line.	Align pulleys.
		Excessive belt installation tension.	Calculate and adjust the belt tension.
	Incorrect pulley execution.	Control pulley dimensions and replace if necessary.	

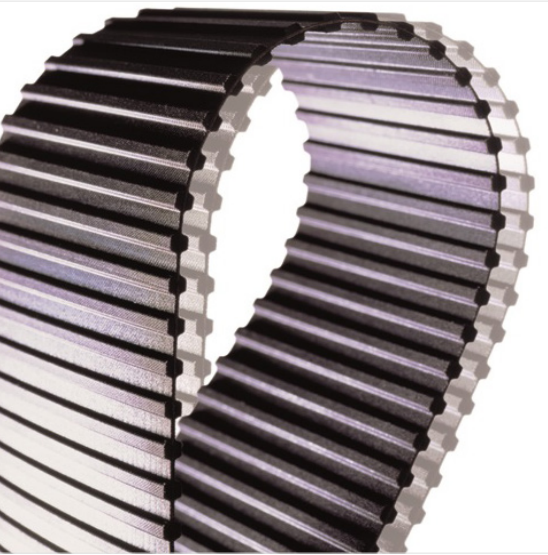

MXL OPEN-ENDED

SPIRAL CUT

STANDARD WIDTHS (inch)	025	031	037
STANDARD WIDTHS (mm)	6,35	7,87	9,39
Weight (gr/m)	8,5	10,5	13,0
Standard roll length and tolerance (m)	160 ± 5	130 ± 5	110 ± 5

Standard compound: **Chloroprene 74 ± 4 ShA**

Standard tooth cover: **nylon fabric**

Standard cord: **glass**

Standard width tolerance: **± 0,4 mm**

Standard thickness tolerance: **± 0,25 mm**

Standard length tolerance: **± 0,8 mm/m**

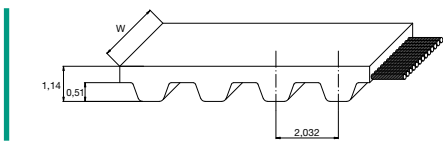

TRACTION RESISTANCE AND ELONGATION DATA

CALCULATION PARAMETERS

BELT WIDTH (inch)	BREAKING STRENGTH (N)
025	640
031	790
037	850

BELT ELONGATION

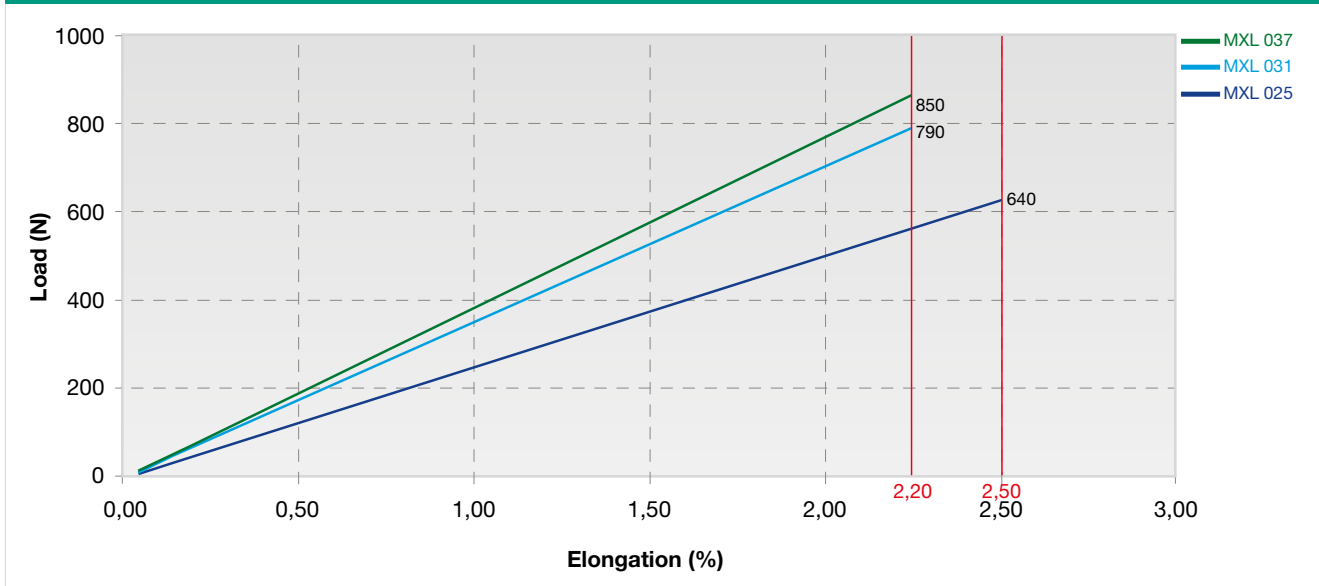

RUBBER OPEN-ENDED

MXL OPEN-ENDED

SPIRAL CUT

TOOTH RESISTANCE

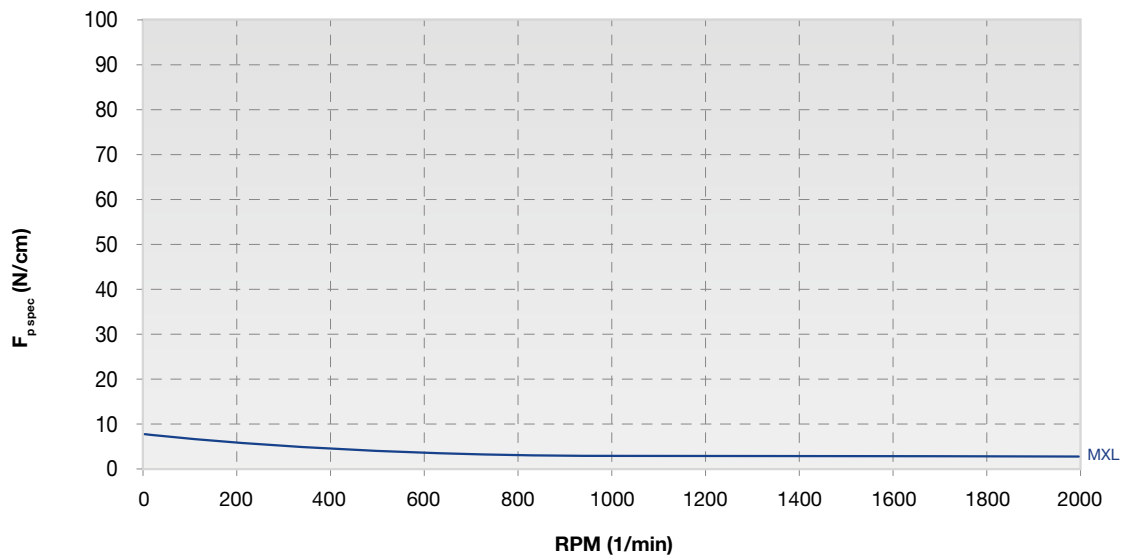

RPM (1/min)	0	10	50	100	200	500	1000	1500	2000
$F_{p \text{ spec}}$ (N/cm)	6,0	5,8	5,5	5,0	4,5	4,0	3,5	3,3	3,0

FLEXION RESISTANCE

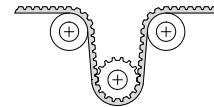
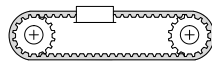

	z_{\min}	z_{\min}	IDLER MIN DIA (mm)
Glass cords	12	14	20

PULLEYS

(FOR MORE DETAILS PLEASE SEE OUR PULLEY CATALOGUE)

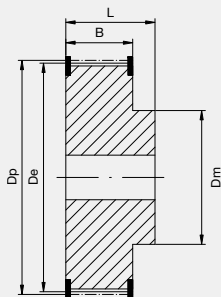

N° TEETH	DP	DE
12	7,76	7,25
13	8,41	7,90
14	9,06	8,55
15	9,70	9,19
16	10,35	9,84
17	11,00	10,49
18	11,64	11,13
19	12,29	11,78
20	12,94	12,43
21	13,58	13,07
22	14,23	13,72
24	15,52	15,01
26	16,82	16,30

N° TEETH	DP	DE
28	18,11	17,60
30	19,40	18,89
32	20,70	20,19
34	21,99	21,48
36	23,29	22,78
40	25,87	25,36
42	27,17	26,66
44	28,46	27,95
48	31,05	30,54
60	38,81	38,30
65	42,04	41,53
72	46,57	46,06

RUBBER OPEN-ENDED

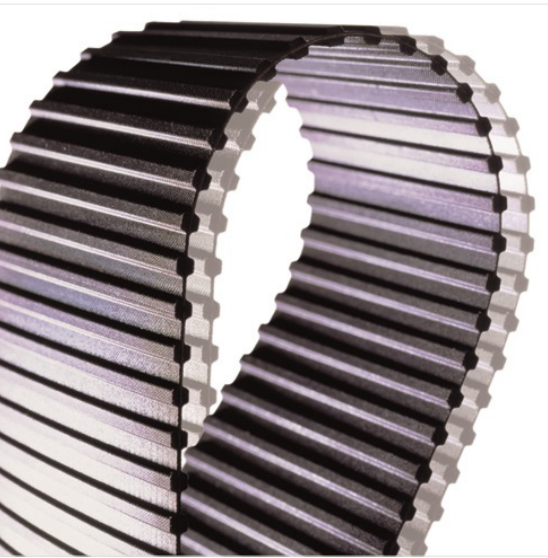

XL OPEN-ENDED

SPIRAL CUT

STANDARD WIDTHS (inch)	025	031	037
STANDARD WIDTHS (mm)	6,35	7,87	9,39
Weight (gr/m)	14,0	17,5	21,0
Standard roll length and tolerance (m)	50 ± 5	50 ± 5	50 ± 5

Standard compound: **Chloroprene 74 ± 4 ShA**

Standard tooth cover: **nylon fabric**

Standard cord: **glass**

Standard width tolerance: **-0,8/+0,4 mm**

Standard thickness tolerance: **± 0,25 mm**

Standard length tolerance: **± 0,8 mm/m**

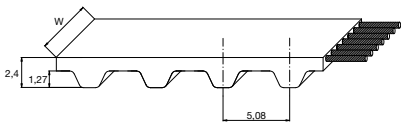

TRACTION RESISTANCE AND ELONGATION DATA

CALCULATION PARAMETERS

BELT WIDTH (inch)	BREAKING STRENGTH (N)
025	930
031	1300
037	1400

BELT ELONGATION

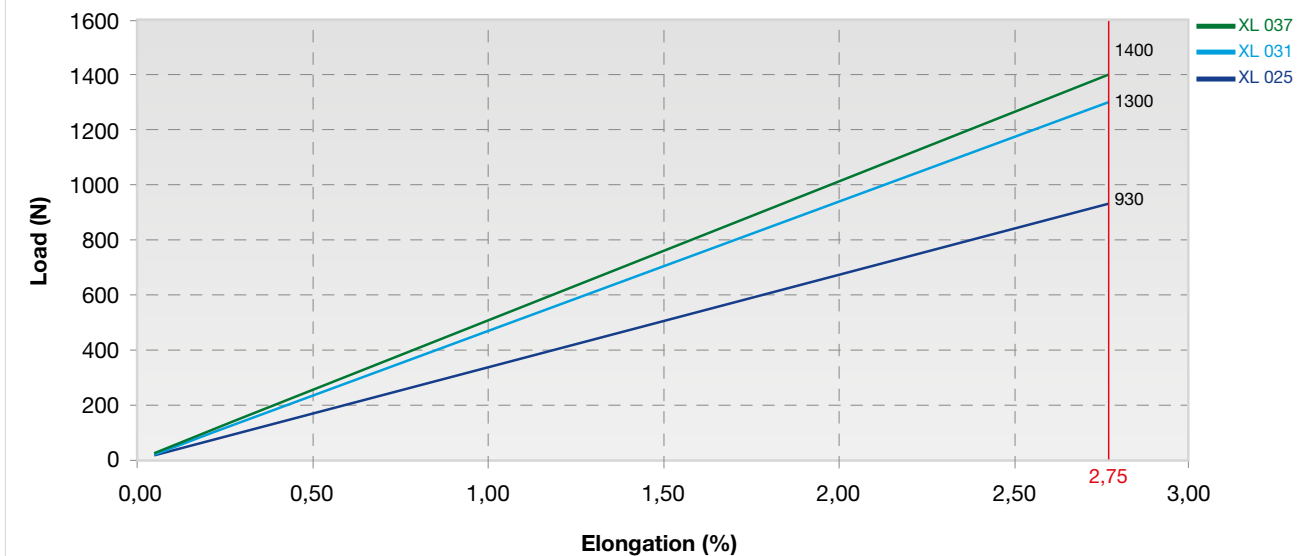

RUBBER OPEN-ENDED

XL OPEN-ENDED

SPIRAL CUT

TOOTH RESISTANCE

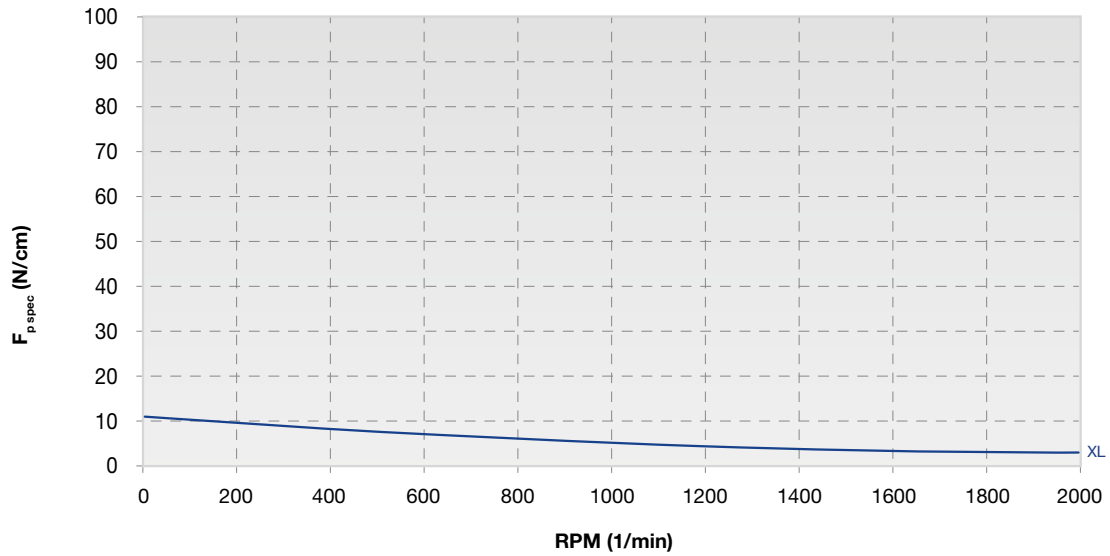

RPM (1/min)	0	10	50	100	200	500	1000	1500	2000
$F_{p\ spec}$ (N/cm)	10,0	9,8	9,5	9,0	8,0	7,3	6,5	6,0	5,8

FLEXION RESISTANCE

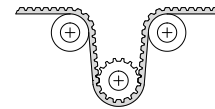
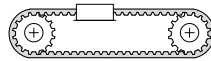

	z_{min}	z_{min}	IDLER MIN DIA (mm)
Glass cords	10	12	35

PULLEYS

(FOR MORE DETAILS PLEASE SEE OUR PULLEY CATALOGUE)

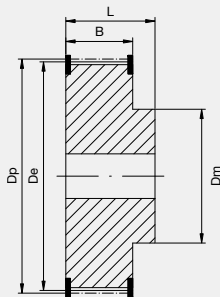

N° TEETH	DP	DE
10	16,17	15,66
11	17,79	17,28
12	19,40	18,89
13	21,02	20,51
14	22,64	22,13
15	24,26	23,75
16	25,87	25,36
17	27,49	26,98
18	29,11	28,60
19	30,72	30,21
20	32,34	31,83
21	33,96	33,45
22	35,57	35,07
24	38,81	38,30

N° TEETH	DP	DE
26	42,04	41,53
27	43,66	43,16
28	45,28	44,77
29	46,89	46,38
30	48,51	48,00
32	51,74	51,23
34	54,98	54,47
35	56,60	56,09
36	58,21	57,70
38	61,45	60,94
39	63,06	62,55
40	64,68	64,17
42	67,91	67,40
44	71,15	70,64

RUBBER OPEN-ENDED

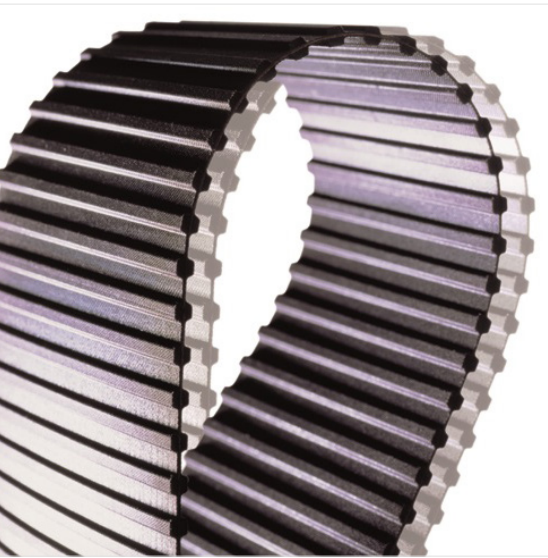

L OPEN-ENDED

SPIRAL CUT

STANDARD WIDTHS (inch)	050	075	100
STANDARD WIDTHS (mm)	12,70	19,05	25,40
Weight (gr/m)	42	62	84
Standard roll length and tolerance (m)	50 -7/+5	50 -7/+5	70 ± 5

Standard compound: **Chloroprene 74 ± 4 ShA**

Standard tooth cover: **nylon fabric**

Standard cord: **glass**

Standard width tolerance: **-0,8/+0,4 mm**

Standard thickness tolerance: **± 0,25 mm**

Standard length tolerance: **± 0,8 mm/m**

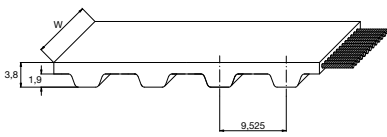

TRACTION RESISTANCE AND ELONGATION DATA

CALCULATION PARAMETERS

BELT WIDTH (inch)	BREAKING STRENGTH (N)
050	2350
075	3480
100	4220

BELT ELONGATION

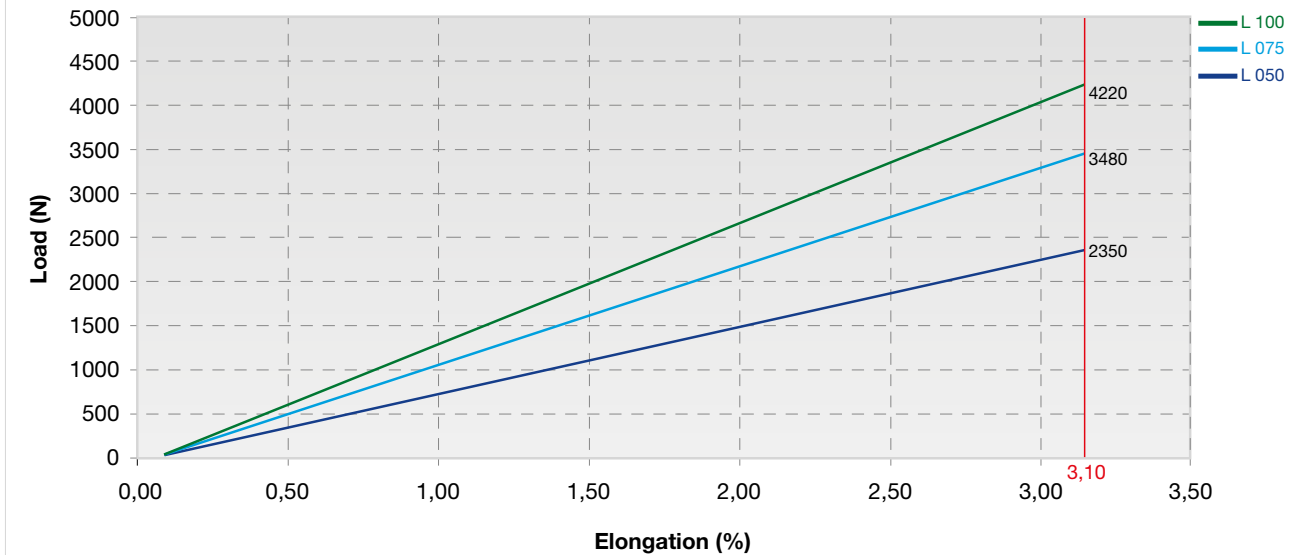

RUBBER OPEN-ENDED

L OPEN-ENDED

SPIRAL CUT

TOOTH RESISTANCE

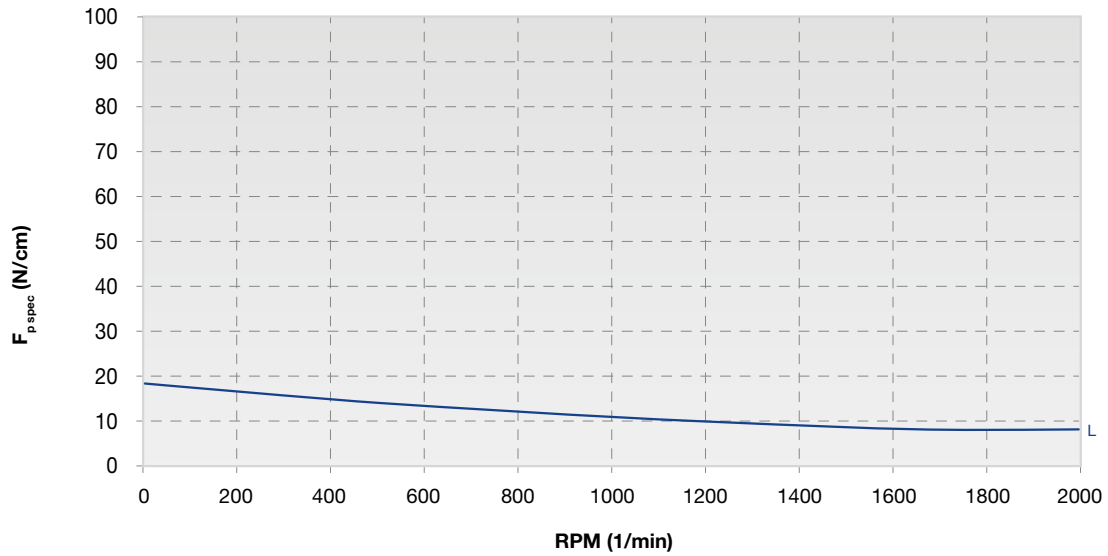

RPM (1/min)	0	10	50	100	200	500	1000	1500	2000
F _{p spec} (N/cm)	18	18	17	17	16	13	11	10	9

FLEXION RESISTANCE

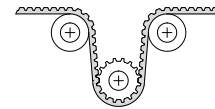
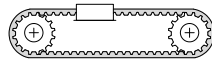

	z_{min}	z_{min}	IDLER MIN DIA (mm)
Glass cords	10	14	60

PULLEYS

(FOR MORE DETAILS PLEASE SEE OUR PULLEY CATALOGUE)

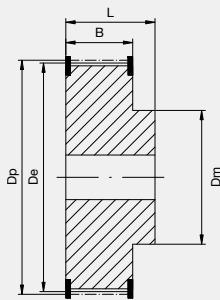

N° TEETH	DP	DE
10	31,27	30,51
12	36,38	35,62
14	42,45	41,69
15	45,48	44,72
16	48,51	47,75
17	51,54	50,78
18	54,57	53,81
19	57,61	56,85
20	60,64	59,88
21	63,67	62,91
22	66,70	65,94
23	69,73	68,97
24	72,77	72,01

N° TEETH	DP	DE
25	75,80	75,04
26	78,83	78,07
27	81,86	81,10
28	84,89	84,13
29	87,93	87,17
30	90,96	90,20
32	97,02	96,26
34	103,08	102,32
36	109,15	108,39
40	121,28	120,52
44	133,40	132,64
48	145,53	144,76

RUBBER OPEN-ENDED

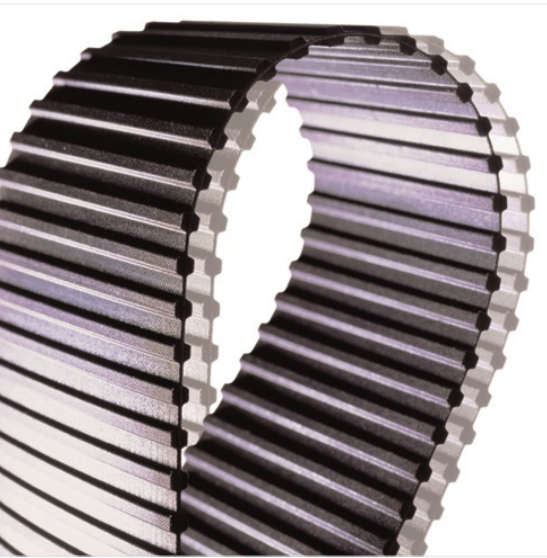

H OPEN-ENDED

STRAIGHT CUT

STANDARD WIDTHS (inch)	050	075	100	150	200	300
STANDARD WIDTHS (mm)	12,70	19,05	25,40	38,10	50,80	76,20
Weight (gr/m)	55	82	110	165	220	330
Standard roll length and tolerance (m)	50 ± 5	50 ± 5	50 ± 5	50 ± 5	50 ± 5	50 ± 5

Standard compound: **Chloroprene 74 ± 4 ShA**

Standard tooth cover: **nylon fabric**

Standard cord: **glass**

Standard width tolerance: **± 0,8 mm**

Standard thickness tolerance: **± 0,60 mm**

Standard length tolerance: **± 0,8 mm/m**

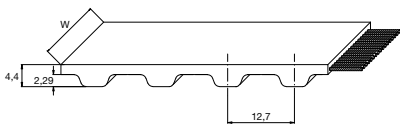

TRACTION RESISTANCE AND ELONGATION DATA

CALCULATION PARAMETERS

BELT WIDTH (inch)	BREAKING STRENGTH (N)
050	4800
075	8710
100	10495
150	15370
200	20990
300	30740

BELT ELONGATION

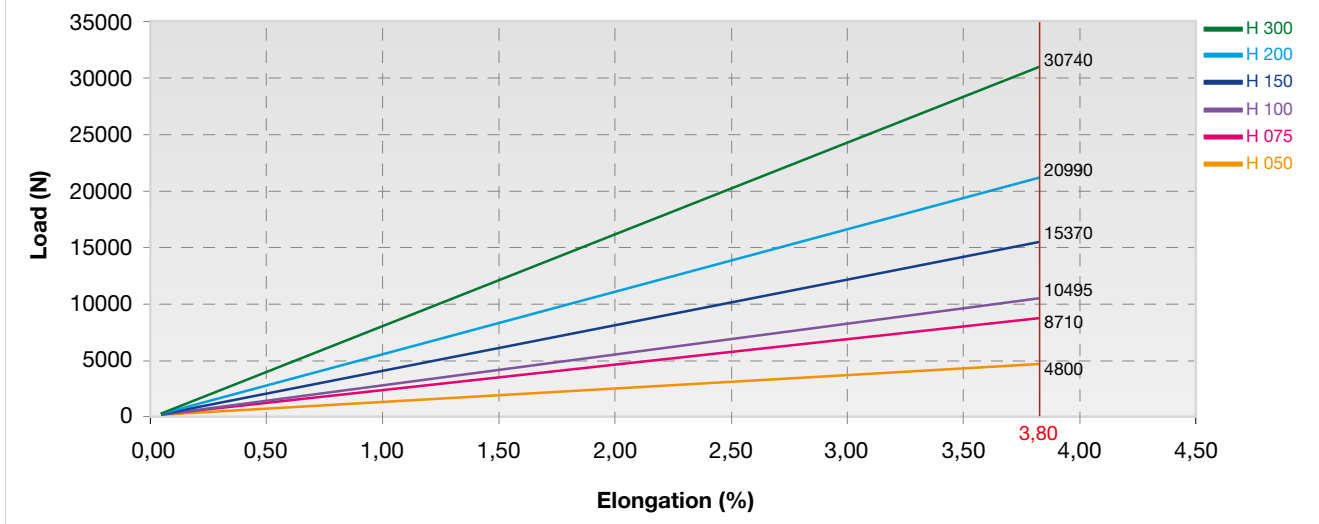

RUBBER OPEN-ENDED

H OPEN-ENDED

STRAIGHT CUT

TOOTH RESISTANCE

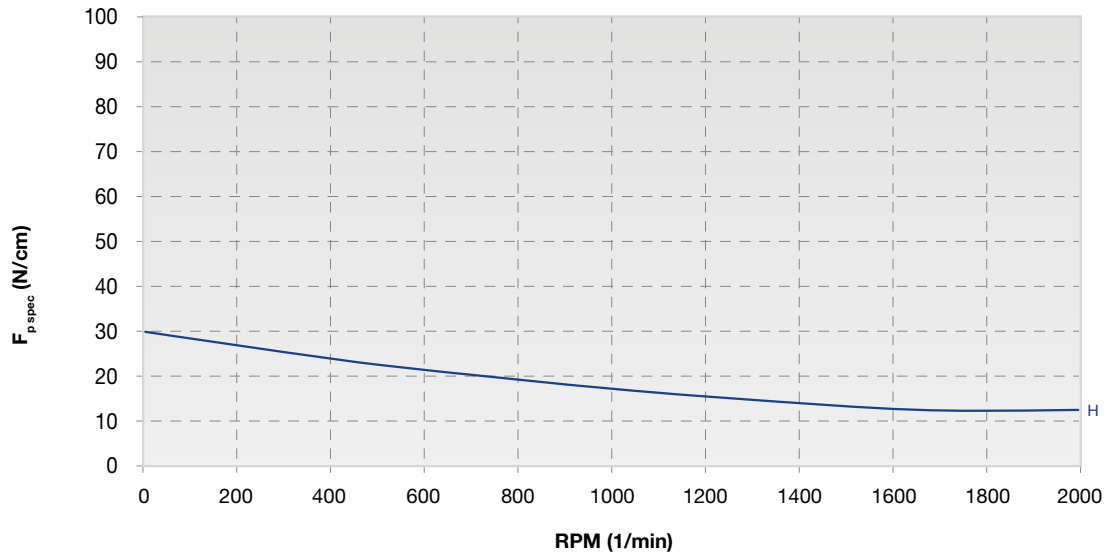

RPM (1/min)	0	10	50	100	200	500	1000	1500	2000
F _{p spec} (N/cm)	30	29	28	27	25	22	18	16	14

FLEXION RESISTANCE

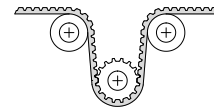
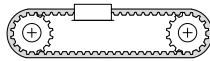

	z_{min}	z_{min}	IDLER MIN DIA (mm)
Glass cords	14	14	80

PULLEYS

(FOR MORE DETAILS PLEASE SEE OUR PULLEY CATALOGUE)

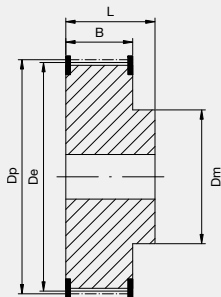

N° TEETH	DP	DE
14	56,60	55,23
15	60,64	59,27
16	64,68	63,31
17	68,72	67,35
18	72,77	71,40
19	76,81	75,44
20	80,85	79,48
21	84,89	83,52
22	88,94	87,57
23	92,98	91,61
24	97,02	95,65
25	101,06	99,69
26	105,11	103,74
27	109,15	107,78

N° TEETH	DP	DE
28	113,19	111,82
29	117,23	115,86
30	121,28	119,91
32	129,36	127,99
33	133,40	132,03
34	137,45	136,08
35	141,49	140,12
36	145,53	144,16
38	153,62	152,25
40	161,70	160,33
44	177,87	176,50
48	194,04	192,67
52	210,21	208,84
60	242,55	241,18

RUBBER OPEN-ENDED

RPP3 OPEN-ENDED

SPIRAL CUT

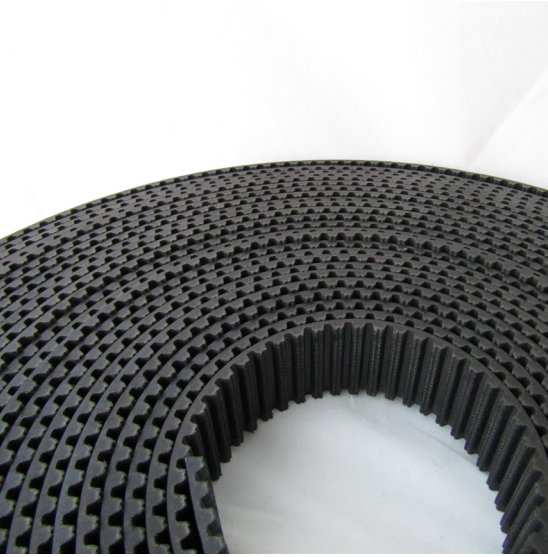

STANDARD WIDTHS (mm)	9	12	15
Weight (gr/m)	21	28	35
Standard roll length and tolerance (m)	50 ± 5	50 ± 5	50 ± 5

Standard compound:	Chloroprene 74 ± 4 ShA
Standard tooth cover:	nylon fabric
Standard cord:	glass
Standard width tolerance:	± 0,4 mm
Standard thickness tolerance:	± 0,25 mm
Standard length tolerance:	± 0,8 mm/m

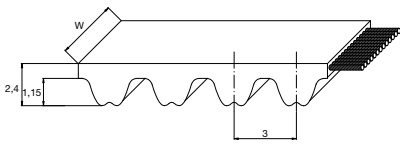

TRACTION RESISTANCE AND ELONGATION DATA

CALCULATION PARAMETERS

BELT WIDTH (mm)	BREAKING STRENGTH (N)
9	1570
12	2100
15	2630

BELT ELONGATION

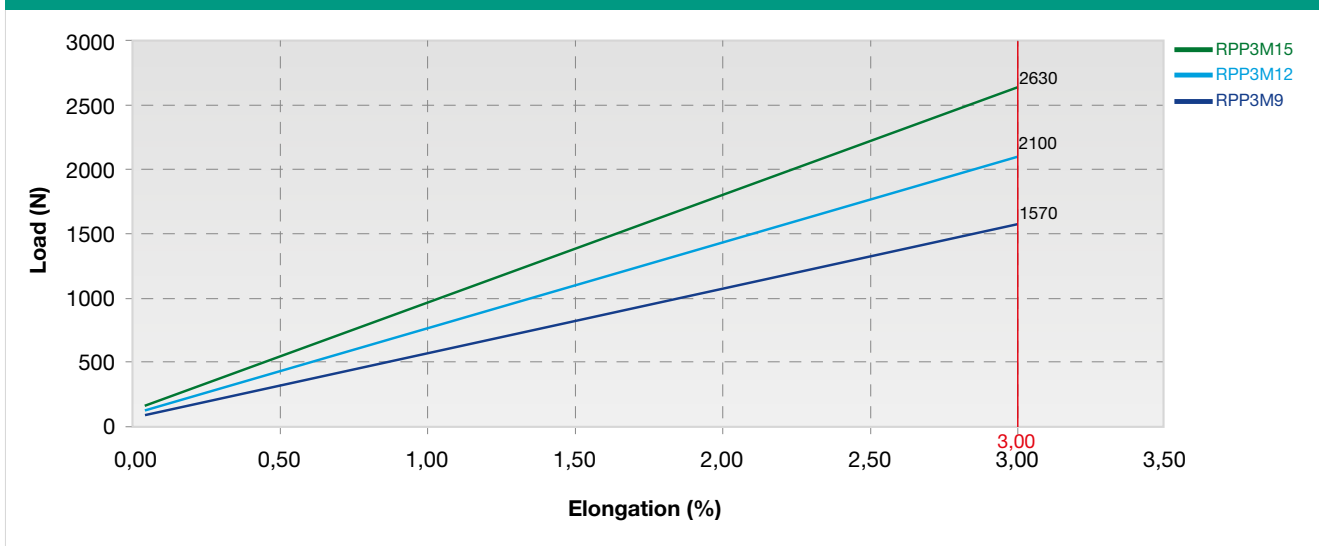

RPP3 OPEN-ENDED

SPIRAL CUT

TOOTH RESISTANCE

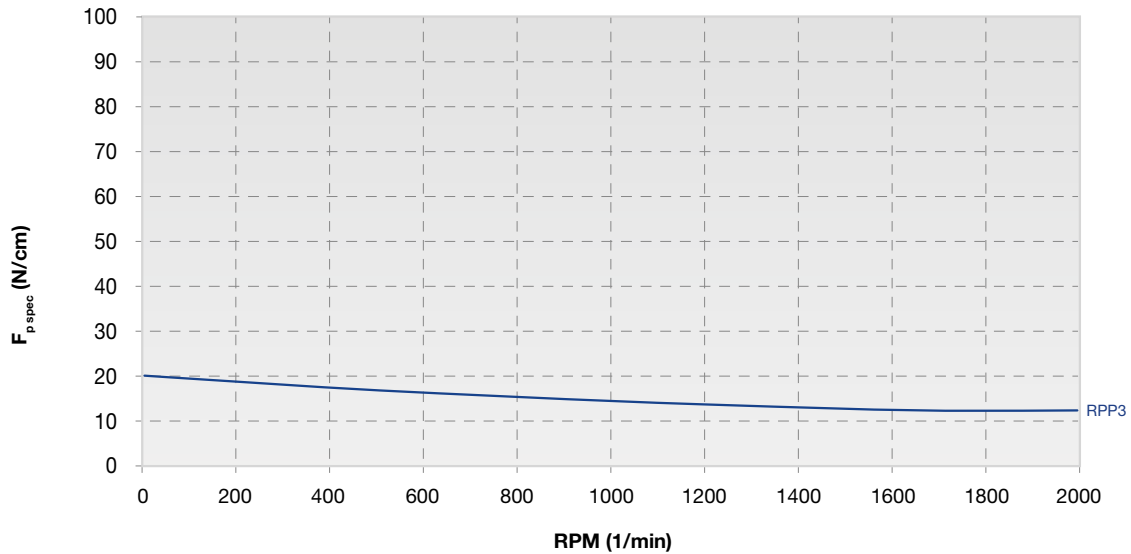

RPM (1/min)	0	10	50	100	200	500	1000	1500	2000
$F_{p\ spec}$ (N/cm)	21	21	20	20	19	17	15	14	13

Meshing Check is strongly suggested because of the belt's elasticity.

To safeguard the correct meshing it might be possible that Meshing Check leads to a wider belt.

FLEXION RESISTANCE

			IDLER MIN DIA (mm)
Glass cords	z_{min} 10	z_{min} 14	30

PULLEYS

(FOR MORE DETAILS PLEASE SEE OUR PULLEY CATALOGUE)

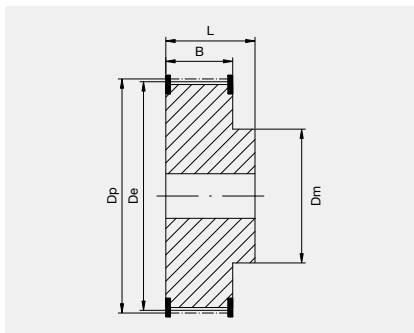

N° TEETH	DP	DE
10	9,55	8,79
12	11,46	10,70
14	13,37	12,61
16	15,28	14,52
18	17,19	16,43
20	19,10	18,34
21	20,05	19,29
22	21,01	20,25
24	22,92	22,16
26	24,83	24,07

N° TEETH	DP	DE
28	26,74	25,98
30	28,65	27,89
32	30,56	29,80
36	34,38	33,62
40	38,20	37,44
44	42,02	41,25
48	45,84	45,07
60	57,30	56,53
72	68,75	67,99

RPP5 OPEN-ENDED

STRAIGHT CUT

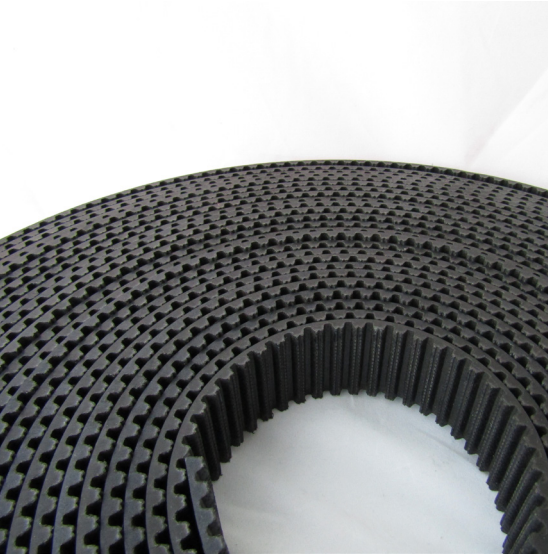

STANDARD WIDTHS (mm)	9	12	15	20	25	30
Weight (gr/m)	40	54	67	90	115	138
Standard roll length and tolerance (m)	50 ± 5	50 ± 5	50 ± 5	50 ± 5	50 ± 5	50 ± 5

Standard compound:	Chloroprene 74 ± 4 ShA
Standard tooth cover:	nylon fabric
Standard cord:	glass
Standard width tolerance:	± 0,5 mm
Standard thickness tolerance:	± 0,25 mm
Standard length tolerance:	± 0,8 mm/m

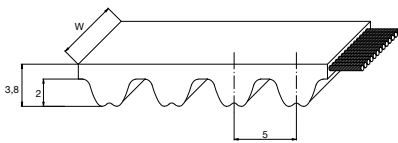

TRACTION RESISTANCE AND ELONGATION DATA

CALCULATION PARAMETERS

BELT WIDTH (mm)	BREAKING STRENGTH (N)
9	3490
12	5040
15	5820
20	7780
25	11150
30	12950

BELT ELONGATION

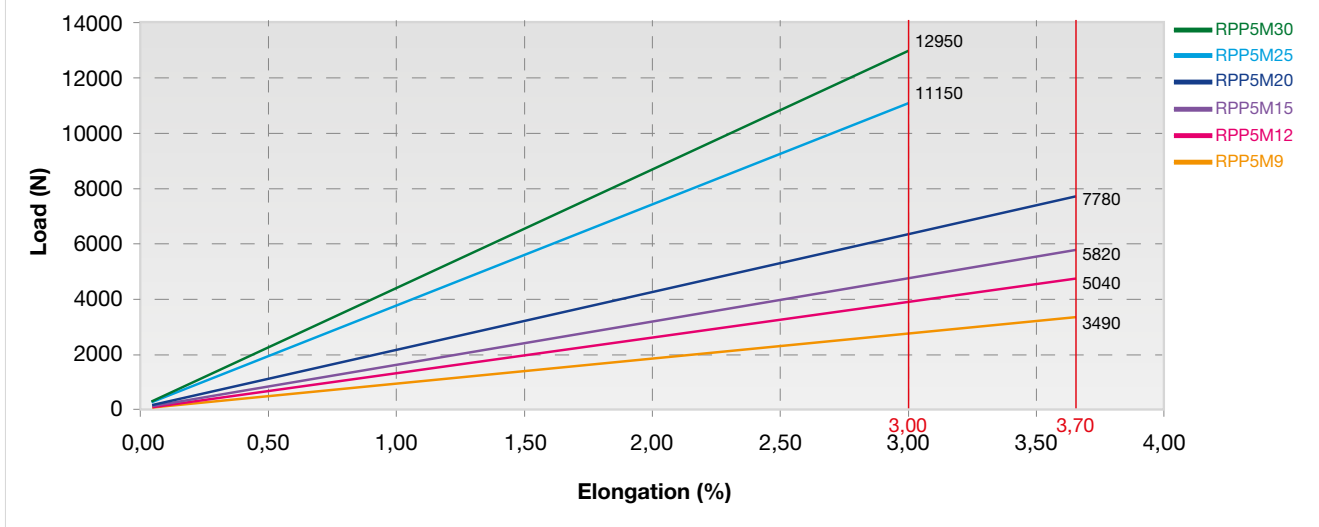

RPP5 OPEN-ENDED

STRAIGHT CUT

TOOTH RESISTANCE

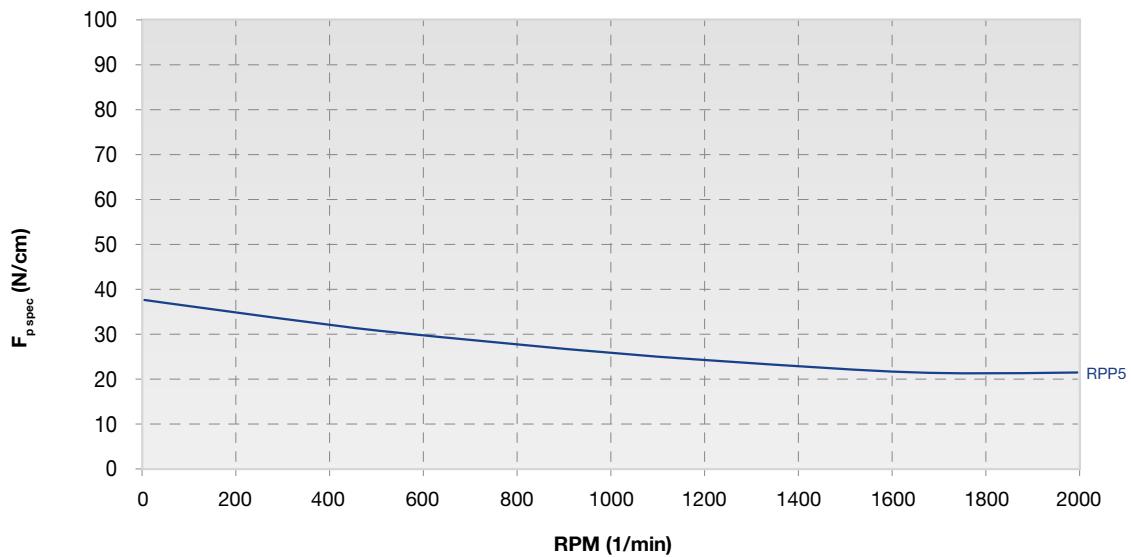

RPM (1/min)	0	10	50	100	200	500	1000	1500	2000
$F_{p\ spec}$ (N/cm)	38	38	37	36	34	31	26	23	22

Meshing Check is strongly suggested because of the belt's elasticity.

To safeguard the correct meshing it might be possible that Meshing Check leads to a wider belt.

FLEXION RESISTANCE

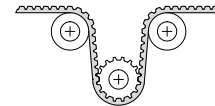
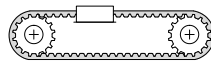

	z_{min}	z_{min}	IDLER MIN DIA (mm)
Glass cords	12	16	50

PULLEYS

(FOR MORE DETAILS PLEASE SEE OUR PULLEY CATALOGUE)

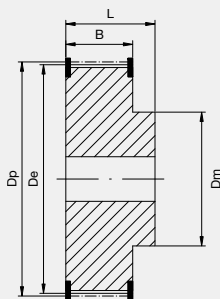

N° TEETH	DP	DE
12	19,10	17,96
14	22,28	21,14
15	23,87	22,73
16	25,46	24,32
18	28,65	27,50
20	31,83	30,69
21	33,42	32,28
22	35,01	33,87
24	38,20	37,05
26	41,38	40,24

N° TEETH	DP	DE
28	44,56	43,42
30	47,75	46,60
32	50,93	49,79
36	57,30	56,15
40	63,66	62,52
44	70,03	68,89
48	76,39	75,25
60	95,49	94,35
72	114,59	113,45

RUBBER OPEN-ENDED

RPP8 OPEN-ENDED

STRAIGHT CUT

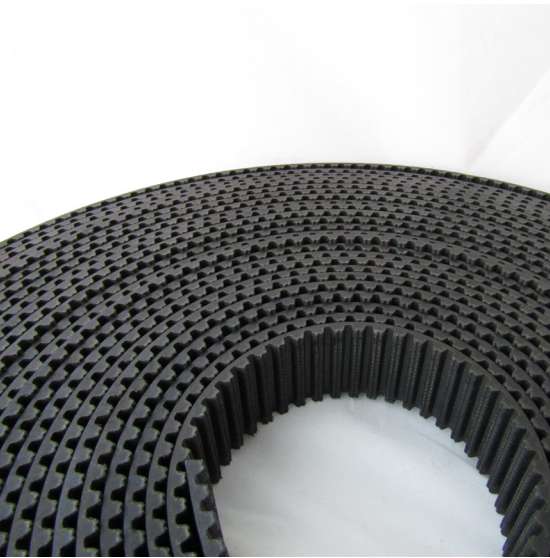

STANDARD WIDTHS (mm)	10	15	20	25	30	50	85
Weight (gr/m)	55	83	110	138	166	276	470
Standard roll length and tolerance (m)	50 ± 5	50 ± 5	50 ± 5	50 ± 5	50 ± 5	50 ± 5	50 ± 5

Standard compound: **Chloroprene 74 ± 4 ShA**

Standard tooth cover: **nylon fabric**

Standard cord: **glass**

Standard width tolerance: **± 0,5 mm**

Standard thickness tolerance: **± 0,40 mm**

Standard length tolerance: **± 0,8 mm/m**

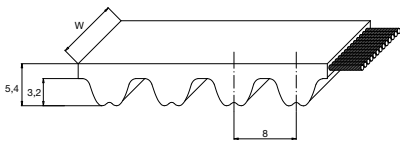

TRACTION RESISTANCE AND ELONGATION DATA

CALCULATION PARAMETERS

BELT WIDTH (mm)	BREAKING STRENGTH (N)
10	4200
15	6650
20	7850
25	11100
30	14440
50	24100
85	40950

BELT ELONGATION

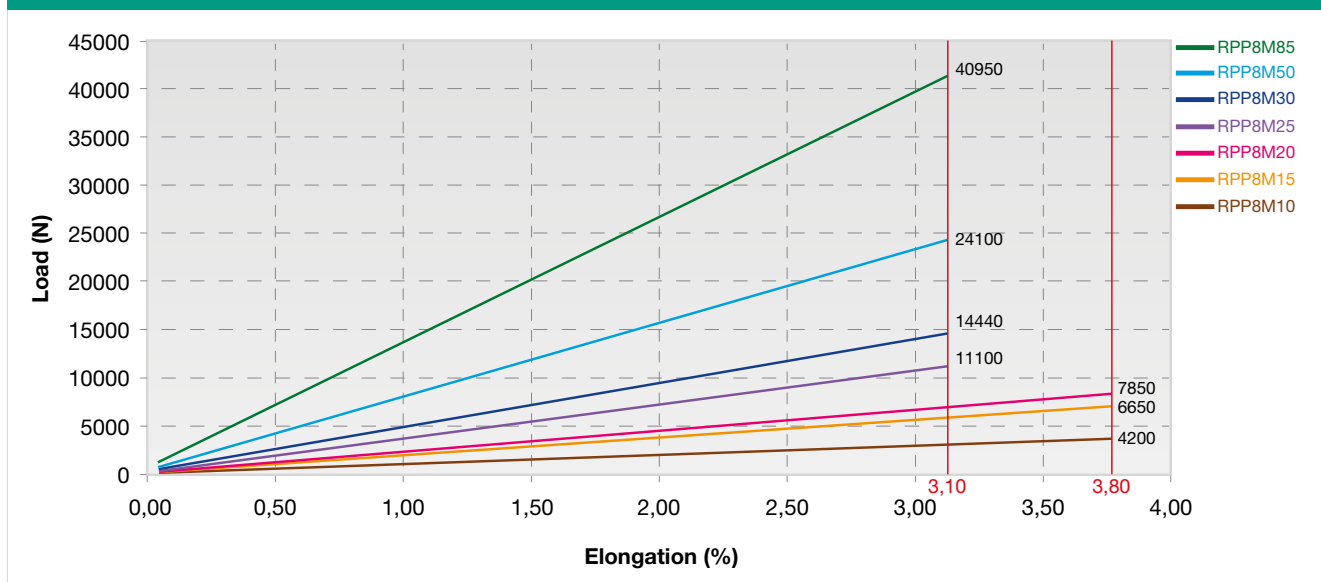

RPP8 OPEN-ENDED

STRAIGHT CUT

TOOTH RESISTANCE

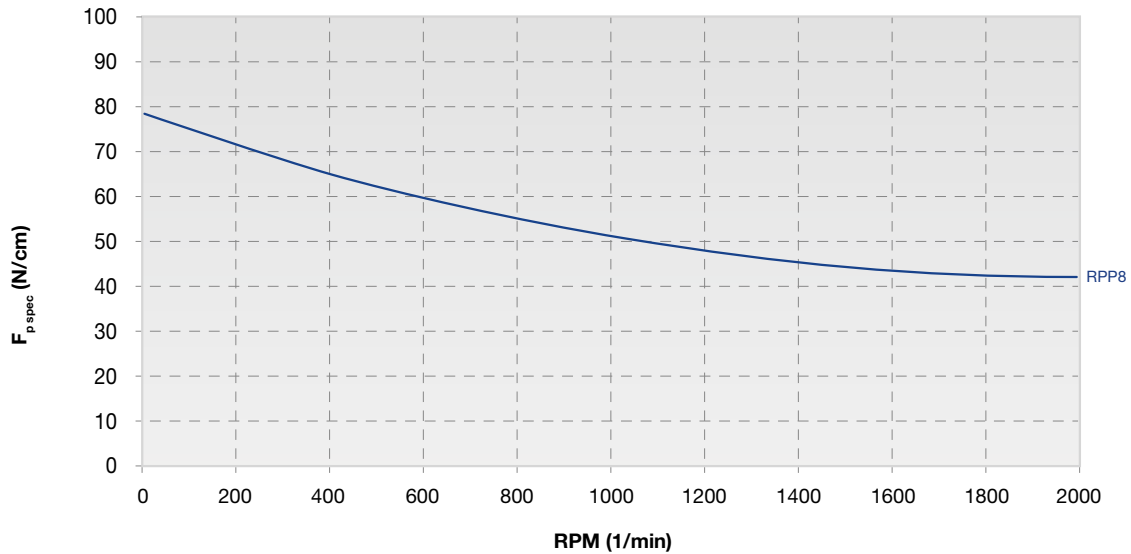

RPM (1/min)	0	10	50	100	200	500	1000	1500	2000
$F_{p\text{ spec}}$ (N/cm)	78	77	76	74	70	61	51	47	44

Meshing Check is strongly suggested because of the belt's elasticity.

To safeguard the correct meshing it might be possible that Meshing Check leads to a wider belt.

FLEXION RESISTANCE

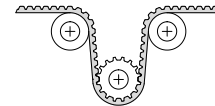
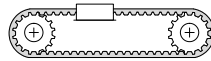

	z_{\min}	z_{\min}	IDLER MIN DIA (mm)
Glass cords	22	22	100

PULLEYS

(FOR MORE DETAILS PLEASE SEE OUR PULLEY CATALOGUE)

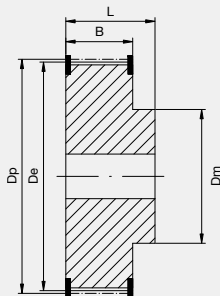

N° TEETH	DP	DE
22	56,02	54,65
24	61,12	59,74
26	66,21	64,84
28	71,30	69,93
30	76,39	75,02
32	81,49	80,12
34	86,58	85,21
36	91,67	90,30
38	96,77	95,39
40	101,86	100,49
44	112,05	110,67

N° TEETH	DP	DE
48	122,23	120,86
54	137,51	136,14
64	162,97	161,60
72	183,35	181,97
80	203,72	202,35
90	229,18	227,81
112	285,20	283,83
144	366,69	365,32
168	427,81	426,44
192	488,92	487,55

RUBBER OPEN-ENDED

RPP8 OPEN-ENDED

STEEL CORDS - STRAIGHT CUT

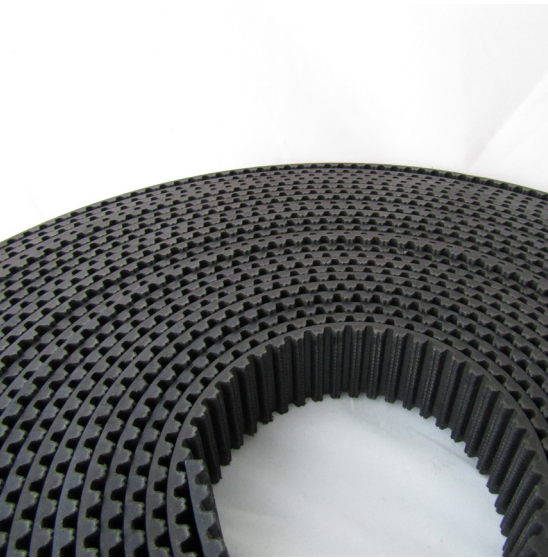

STANDARD WIDTHS (mm) *	10	15	20	30	50
Weight (gr/m)	96	149	202	309	517
Standard roll length and tolerance (m)	30 -0/+1	30 -0/+1	30 -0/+1	30 -0/+1	30 -0/+1

* Wider belts on request

Standard compound:	EPDM 89 ± 4 ShA
Standard tooth cover:	nylon fabric
Standard back:	grinded
Standard cord:	S and Z torsion zinked steel
Standard width tolerance for W ≤ 30:	± 0,8 mm
Standard width tolerance for W = 50:	± 1,2 mm
Standard thickness tolerance:	± 0,3 mm
Standard length tolerance:	± 0,8 mm/m

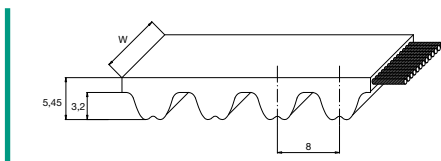

TRACTION RESISTANCE AND ELONGATION DATA

CALCULATION PARAMETERS

BELT WIDTH (mm)	BREAKING STRENGTH (N)
10	6400
15	11200
20	16870
30	28200
50	43200

BELT ELONGATION

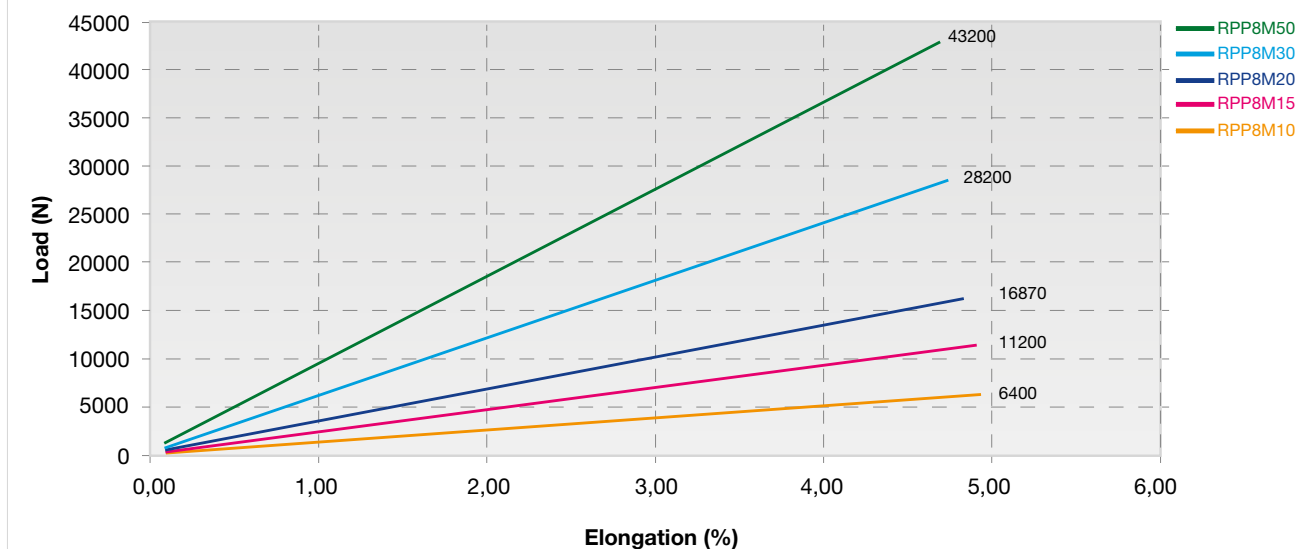

RPP8 OPEN-ENDED

STEEL CORDS - STRAIGHT CUT

TOOTH RESISTANCE

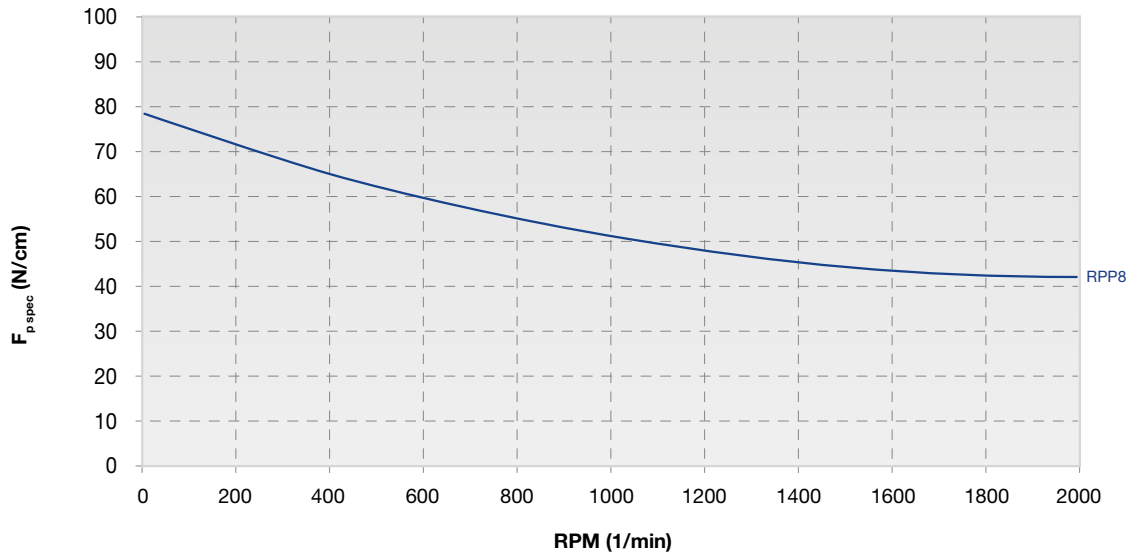

RPM (1/min)	0	10	50	100	200	500	1000	1500	2000
$F_{p\text{ spec}}$ (N/cm)	78	77	76	74	70	61	51	47	44

Meshing Check is strongly suggested because of the belt's elasticity.

To safeguard the correct meshing it might be possible that Meshing Check leads to a wider belt.

FLEXION RESISTANCE

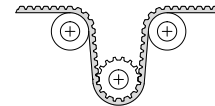
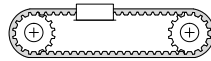

	z_{min}	z_{min}	IDLER MIN DIA (mm)
Glass cords	22	30	150

PULLEYS

(FOR MORE DETAILS PLEASE SEE OUR PULLEY CATALOGUE)

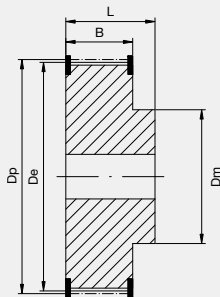

N° TEETH	DP	DE
22	56,02	54,65
24	61,12	59,74
26	66,21	64,84
28	71,30	69,93
30	76,39	75,02
32	81,49	80,12
34	86,58	85,21
36	91,67	90,30
38	96,77	95,39

N° TEETH	DP	DE
40	101,86	100,49
44	112,05	110,67
48	122,23	120,86
54	137,51	136,14
64	162,97	161,60
72	183,35	181,97
80	203,72	202,35
90	229,18	227,81

RUBBER OPEN-ENDED

RPP14 OPEN-ENDED

STEEL CORDS - STRAIGHT CUT

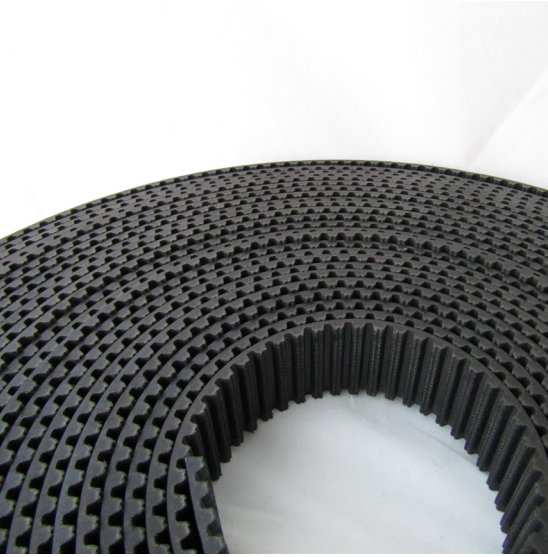

STANDARD WIDTHS (mm) *	25	40	55	85
Weight (gr/m)	351	562	772	1194
Standard roll length and tolerance (m)	30 -0/+1	30 -0/+1	30 -0/+1	30 -0/+1

* Wider belts on request

Standard compound:	EPDM 89 ± 4 ShA
Standard tooth cover:	nylon fabric
Standard back:	grinded
Standard cord:	S and Z torsion zinked steel
Standard width tolerance:	± 1,35 mm
Standard thickness tolerance:	± 0,4 mm
Standard length tolerance:	± 0,8 mm/m

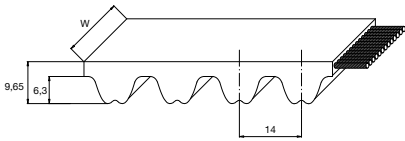

TRACTION RESISTANCE AND ELONGATION DATA

CALCULATION PARAMETERS

BELT WIDTH (mm)	BREAKING STRENGTH (N)
25	49000
40	81000
55	119000
85	182000

BELT ELONGATION

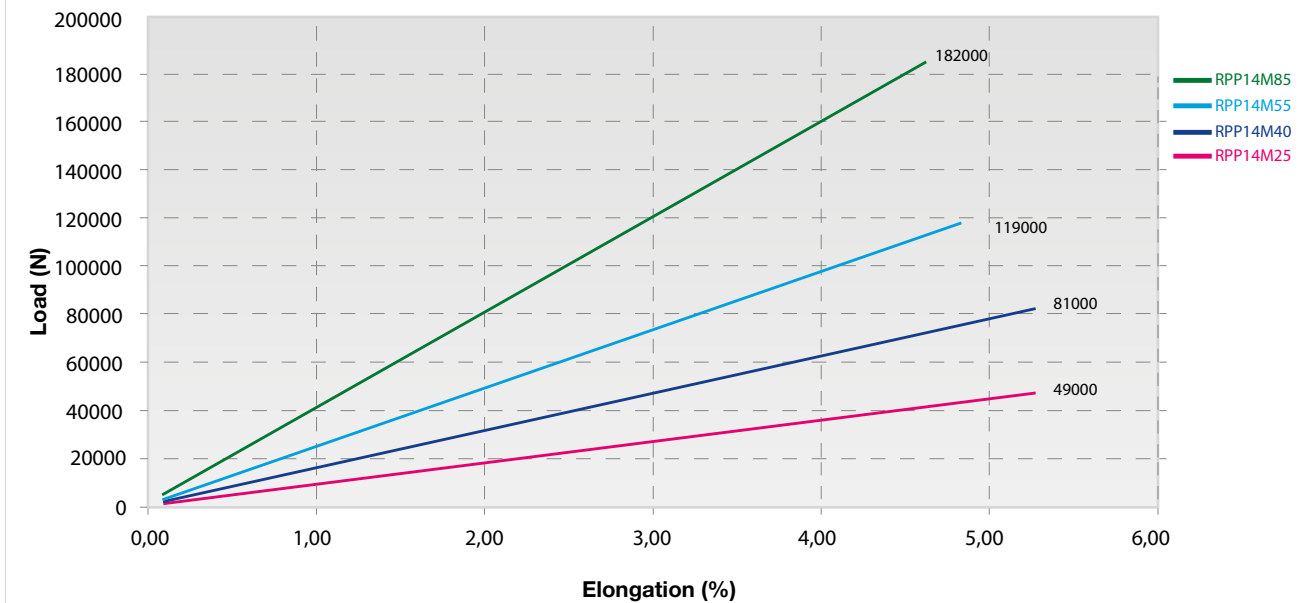

RPP14 OPEN-ENDED

STEEL CORDS - STRAIGHT CUT

TOOTH RESISTANCE

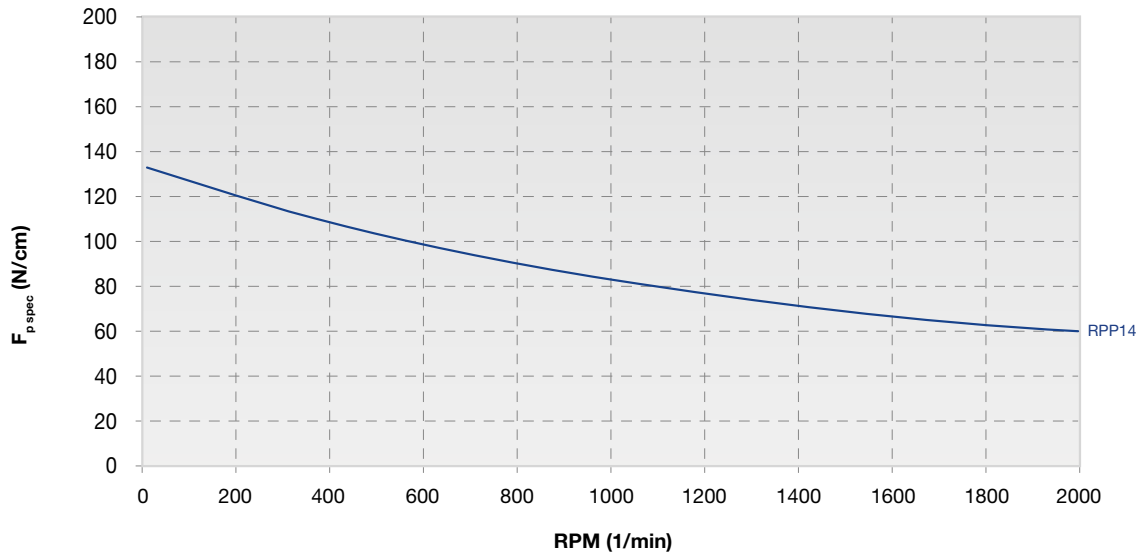

RPM (1/min)	0	10	50	100	200	500	1000	1500	2000
$F_{p\ spec}$ (N/cm)	135	132	129	123	114	97	81	73	60

Meshing Check is strongly suggested because of the belt's elasticity.

To safeguard the correct meshing it might be possible that Meshing Check leads to a wider belt.

FLEXION RESISTANCE

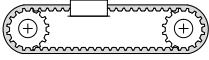
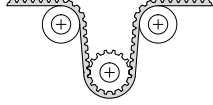
			
	z_{min}	z_{min}	IDLER MIN DIA (mm)
Glass cords	28	35	250

PULLEYS

(FOR MORE DETAILS PLEASE SEE OUR PULLEY CATALOGUE)

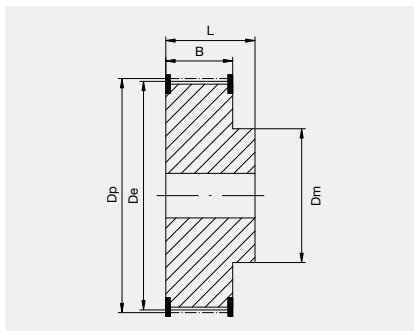

N° TEETH	DP	DE
28	124,78	121,98
30	133,69	130,90
32	142,60	139,81
34	151,52	148,73
36	160,43	157,64
38	169,34	166,55

N° TEETH	DP	DE
40	178,25	175,46
44	169,08	193,29
48	213,90	211,11
54	249,55	246,76
64	285,20	282,41

RUBBER OPEN-ENDED

SILVER3 3M OPEN-ENDED

SPIRAL CUT

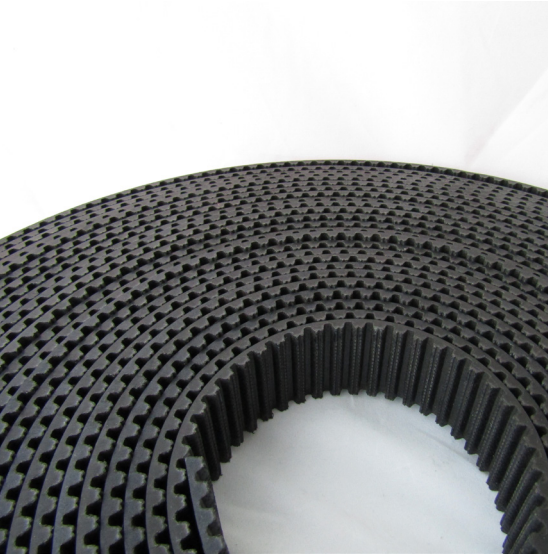

STANDARD WIDTHS (mm)	10	15	20	25
Weight (gr/m)	25	40	52	64
Standard roll length and tolerance (m)	50 ± 5	50 ± 5	50 ± 5	50 ± 5

Standard compound:	NBR
Standard tooth cover:	Nylon fabric
Standard cord:	Fiberglass
Standard width tolerance:	± 0,4 mm
Standard thickness tolerance:	± 0,25 mm
Standard length tolerance:	± 0,8 mm/m

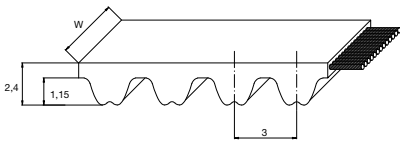

TRACTION RESISTANCE AND ELONGATION DATA

CALCULATION PARAMETERS

BELT WIDTH (mm)	BREAKING STRENGTH (N)
10	1930
15	3030
20	3710
25	4780

BELT ELONGATION

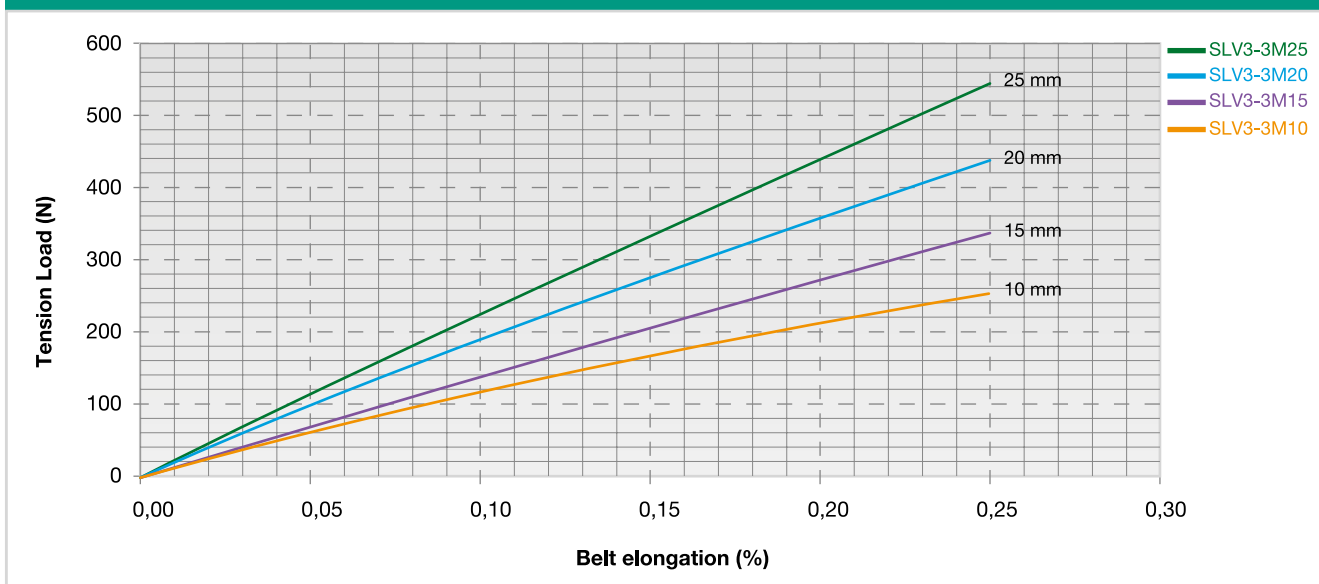

SILVER3 3M OPEN-ENDED

SPIRAL CUT

FLEXION RESISTANCE

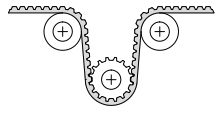
			
	z_{min}	z_{min}	IDLER MIN DIA (mm)
Fiberglass cords	10	14	30

PULLEYS

(FOR MORE DETAILS PLEASE SEE OUR PULLEY CATALOGUE)

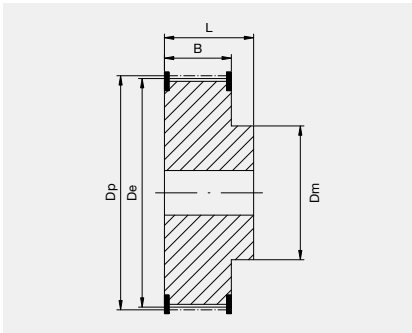

N° TEETH	DP	DE
10	9,55	8,79
12	11,46	10,70
14	13,37	12,61
16	15,28	14,52
18	17,19	16,43
20	19,10	18,34
21	20,05	19,29
22	21,01	20,25
24	22,92	22,16
26	24,83	24,07

N° TEETH	DP	DE
28	26,74	25,98
30	28,65	27,89
32	30,56	29,80
36	34,38	33,62
40	38,20	37,44
44	42,02	41,25
48	45,84	45,07
60	57,30	56,53
72	68,75	67,99

SILVER3 5M OPEN-ENDED

SPIRAL CUT

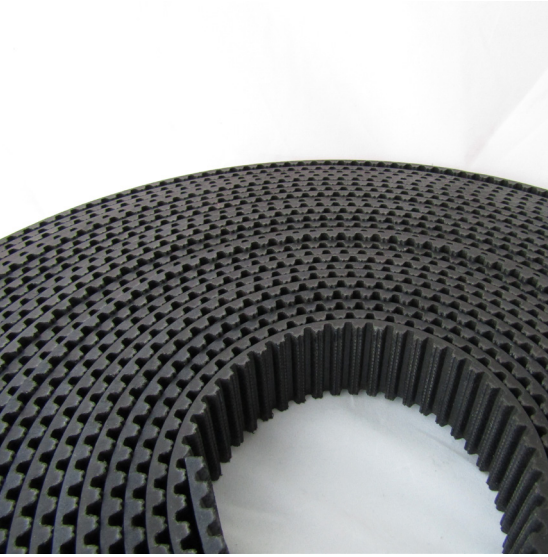

STANDARD WIDTHS (mm)	10	15	20	25	30
Weight (gr/m)	42	63	84	105	126
Standard roll length and tolerance (m)	50 ± 5	50 ± 5	50 ± 5	50 ± 5	50 ± 5

Standard compound: **Nitrile rubber 90 ± 4 ShA**

Standard tooth cover: **Nylon fabric**

Standard cord: **Fiberglass**

Standard width tolerance: **± 0,5 mm**

Standard thickness tolerance: **± 0,25 mm**

Standard length tolerance: **± 0,8 mm/m**

Antistatic in standard version (according ISO 9563)

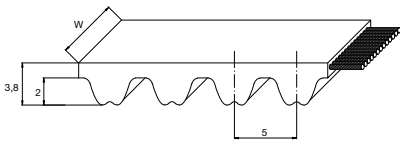

TRACTION RESISTANCE AND ELONGATION DATA

CALCULATION PARAMETERS

BELT WIDTH (mm)	BREAKING STRENGTH (N)
10	3900
15	5780
20	7560
25	9260
30	10.600

BELT ELONGATION

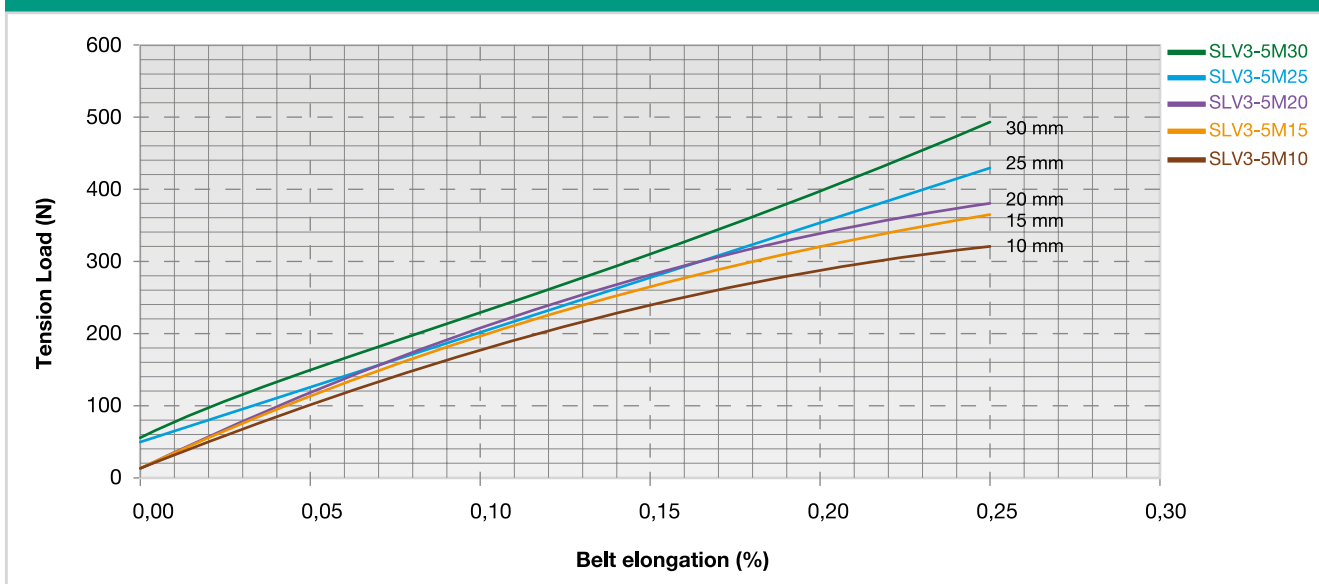

SILVER3 5M OPEN-ENDED

SPIRAL CUT

FLEXION RESISTANCE

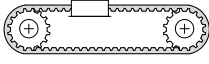
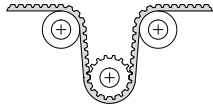
			
	z_{min}	z_{min}	IDLER MIN DIA (mm)
Fiberglass cords	12	16	50

PULLEYS

(FOR MORE DETAILS PLEASE SEE OUR PULLEY CATALOGUE)

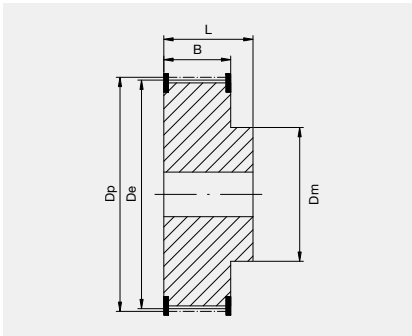

N° TEETH	DP	DE
12	19,10	17,96
14	22,28	21,14
15	23,87	22,73
16	25,46	24,32
18	28,65	27,50
20	31,83	30,69
21	33,42	32,28
22	35,01	33,87
24	38,20	37,05
26	41,38	40,24

N° TEETH	DP	DE
28	44,56	43,42
30	47,75	46,60
32	50,93	49,79
36	57,30	56,15
40	63,66	62,52
44	70,03	68,89
48	76,39	75,25
60	95,49	94,35
72	114,59	113,45

RUBBER OPEN-ENDED

SILVER3 8M OPEN-ENDED

SPIRAL CUT

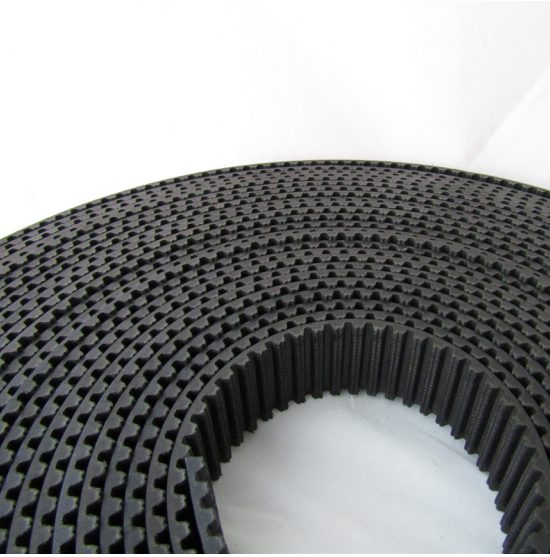

STANDARD WIDTHS (mm)	10	15	20	25	30
Weight (gr/m)	54	81	108	135	162
Standard roll length and tolerance (m)	50 ± 5	50 ± 5	50 ± 5	50 ± 5	50 ± 5

Standard compound: **Nitrile rubber 90 ± 4 ShA**

Standard tooth cover: **Nylon fabric**

Standard cord: **Fiberglass**

Standard width tolerance: **± 0,5 mm**

Standard thickness tolerance: **± 0,40 mm**

Standard length tolerance: **± 0,8 mm/m**

Antistatic in standard version (according ISO 9563)

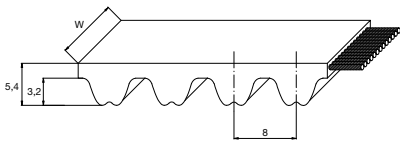

TRACTION RESISTANCE AND ELONGATION DATA

CALCULATION PARAMETERS

BELT WIDTH (mm)	BREAKING STRENGTH (N)
10	6110
15	9930
20	12500
25	16100
30	17600

BELT ELONGATION

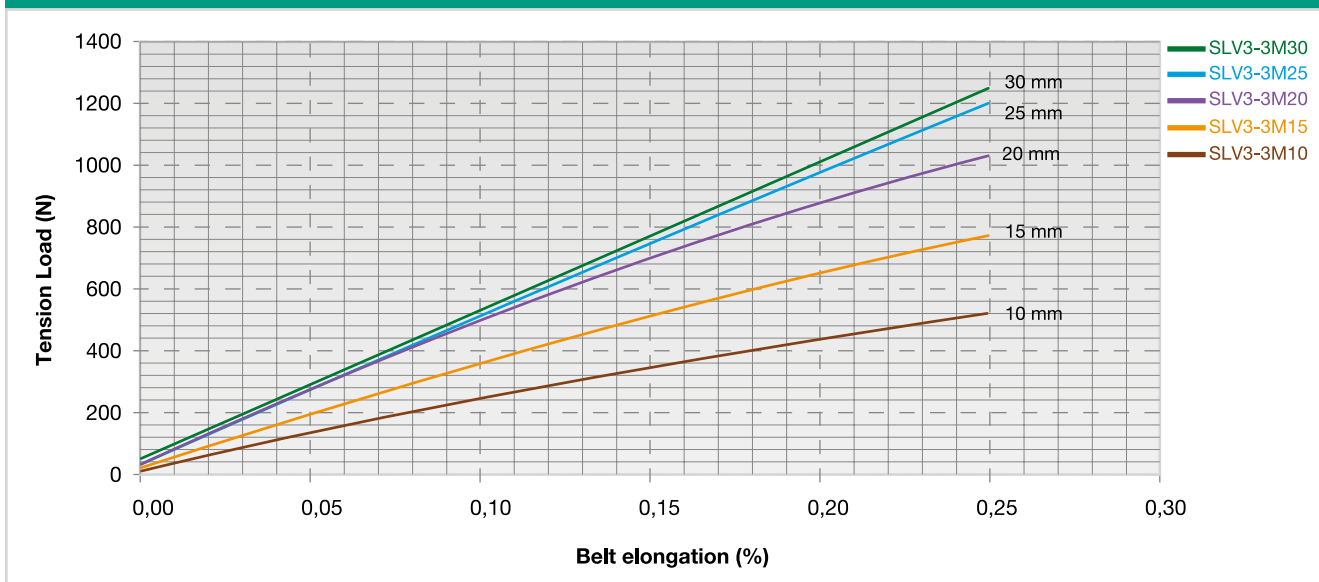

RUBBER OPEN-ENDED

SILVER3 8M OPEN-ENDED

SPIRAL CUT

FLEXION RESISTANCE

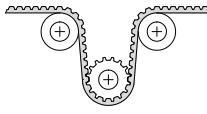
			
	z_{min}	z_{min}	IDLER MIN DIA (mm)
Fiberglass cords	22	22	100

PULLEYS

(FOR MORE DETAILS PLEASE SEE OUR PULLEY CATALOGUE)

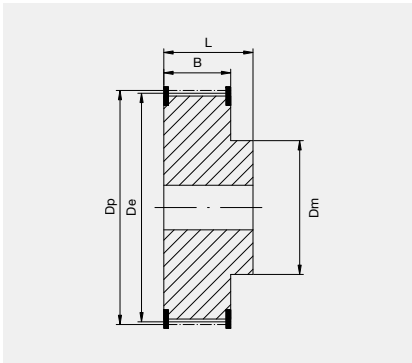

N° TEETH	DP	DE
22	56,02	54,65
24	61,12	59,74
26	66,21	64,84
28	71,30	69,93
30	76,39	75,02
32	81,49	80,12
34	86,58	85,21
36	91,67	90,30
38	96,77	95,39
40	101,86	100,49
44	112,05	110,67

N° TEETH	DP	DE
48	122,23	120,86
54	137,51	136,14
64	162,97	161,60
72	183,35	181,97
80	203,72	202,35
90	229,18	227,81
112	285,21	283,83
144	366,69	365,32
168	427,81	426,44
192	488,92	487,55

TITANIUM 8M OPEN-ENDED

SPIRAL CUT

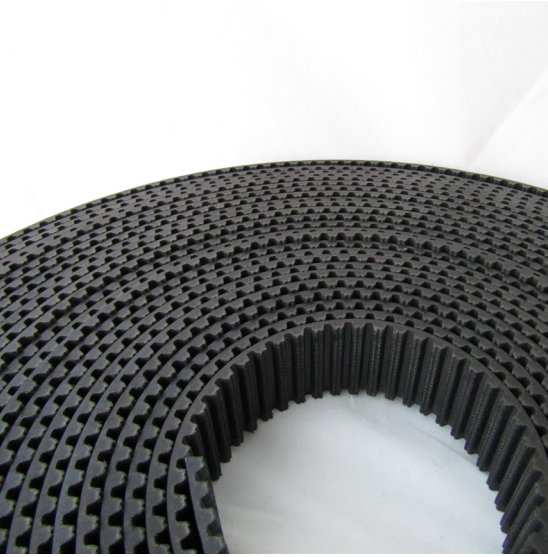

STANDARD WIDTHS (mm)	10	12	15	20	25	30	50
Weight (gr/m)	45	54	67	90	112	135	225
Standard roll length and tolerance (m)	50 ± 5	50 ± 5	50 ± 5	50 ± 5	50 ± 5	50 ± 5	50 ± 5

Standard compound:	HNBR rubber
Standard tooth cover:	High performance fabric with special anti-friction treatment
Standard cord:	100% Carbon Fiber
Standard width tolerance:	± 0,5 mm
Standard thickness tolerance:	± 0,40 mm
Standard length tolerance:	± 0,8 mm/m

Antistatic in standard version (according ISO 9563)

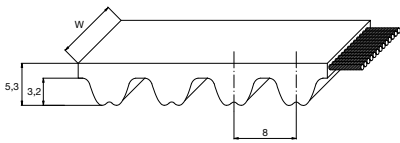

TRACTION RESISTANCE AND ELONGATION DATA

CALCULATION PARAMETERS

BELT WIDTH (mm)	BREAKING STRENGTH (N)
10	10400
12	12900
15	16100
20	20500
25	27900
30	31889
50	54667

BELT ELONGATION

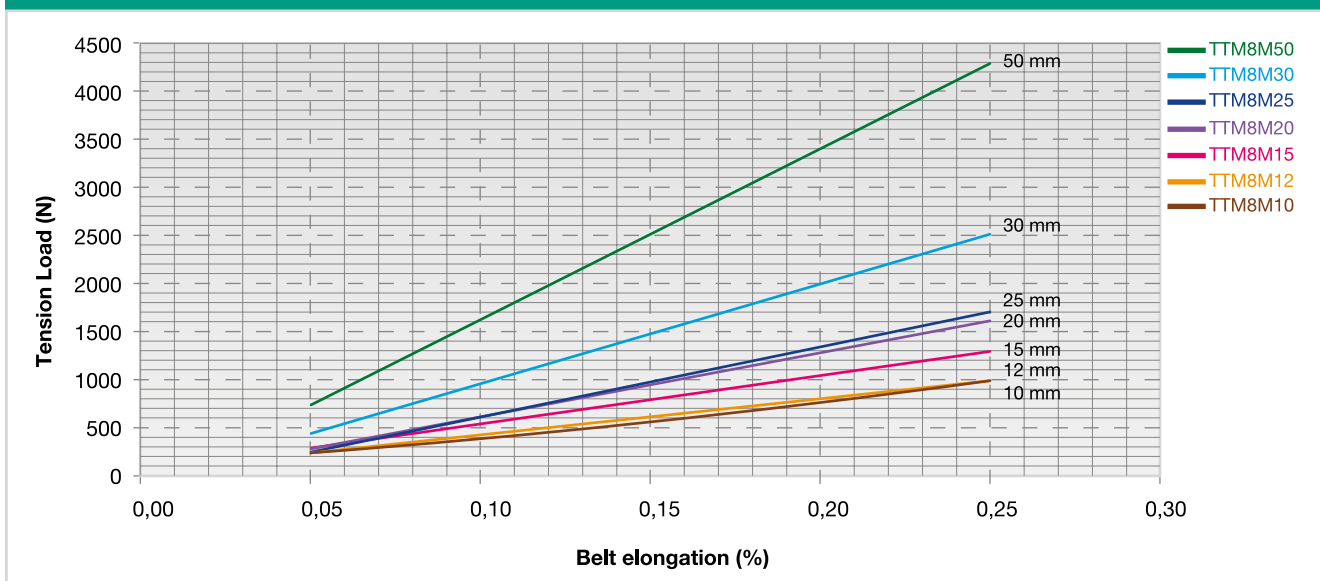

RUBBER OPEN-ENDED

TITANIUM 8M OPEN-ENDED

SPIRAL CUT

FLEXION RESISTANCE

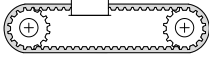
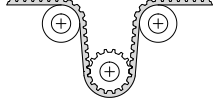
			
	z_{min}	z_{min}	IDLER MIN DIA (mm)
Carbon cords	22	22	100

PULLEYS

(FOR MORE DETAILS PLEASE SEE OUR PULLEY CATALOGUE)

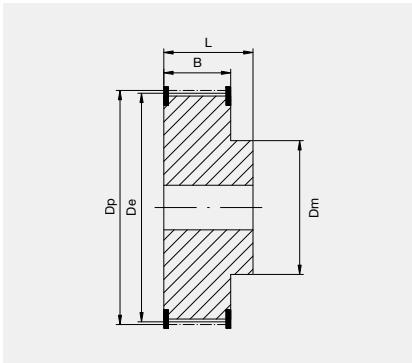

N° TEETH	DP	DE
22	56,02	54,65
24	61,12	59,74
26	66,21	64,84
28	71,30	69,93
30	76,39	75,02
32	81,49	80,12
34	86,58	85,21
36	91,67	90,30
38	96,77	95,39
40	101,86	100,49
44	112,05	110,67

N° TEETH	DP	DE
48	122,23	120,86
54	137,51	136,14
64	162,97	161,60
72	183,35	181,97
80	203,72	202,35
90	229,18	227,81
112	285,21	283,83
144	366,69	365,32
168	427,81	426,44
192	488,92	487,55

RUBBER OPEN-ENDED

TITANIUM 14M OPEN-ENDED

SPIRAL CUT

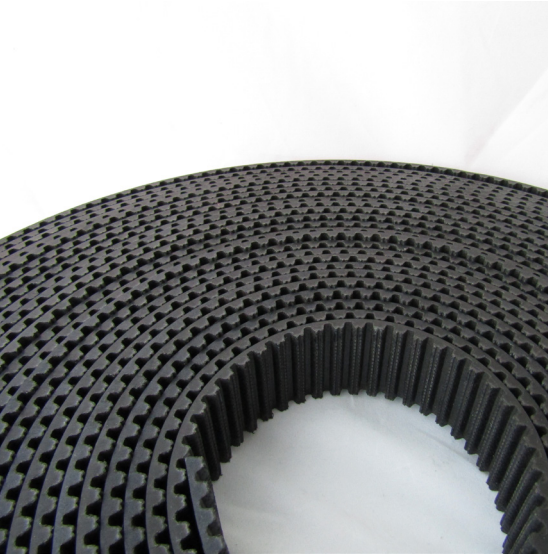

STANDARD WIDTHS (mm)	15	20	25	37
Weight (gr/m)	45	90	112	166
Standard roll length and tolerance (m)	50 ± 5	50 ± 5	50 ± 5	50 ± 5

Standard compound:	HNBR rubber
Standard tooth cover:	High performance fabric with special anti-friction treatment
Standard cord:	100% Carbon Fiber
Standard width tolerance:	± 1,35 mm
Standard thickness tolerance:	± 0,4 mm
Standard length tolerance:	± 0,8 mm/m

Antistatic in standard version (according ISO 9563)

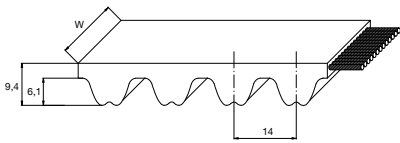

TRACTION RESISTANCE AND ELONGATION DATA

CALCULATION PARAMETERS

BELT WIDTH (mm)	BREAKING STRENGTH (N)
15	29165
20	36779
25	45432
37	73709

BELT ELONGATION

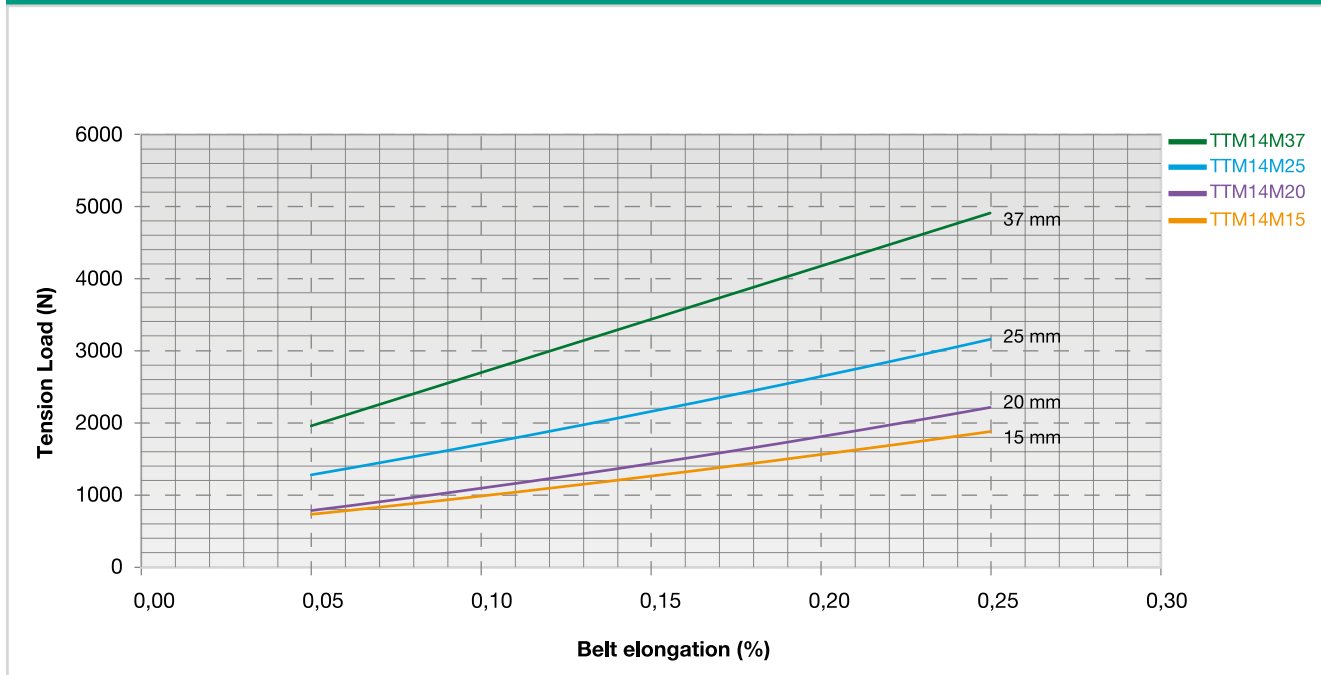

RUBBER OPEN-ENDED

TITANIUM 14M OPEN-ENDED

SPIRAL CUT

FLEXION RESISTANCE

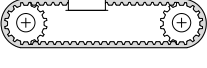
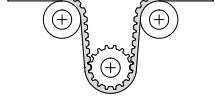
		
	z_{min}	z_{min} IDLER MIN DIA (mm)
Carbon cords	28	35 250

PULLEYS

(FOR MORE DETAILS PLEASE SEE OUR PULLEY CATALOGUE)

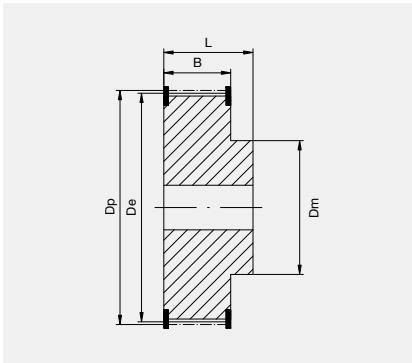

N° TEETH	DP	DE
28	124,78	121,98
30	133,69	130,90
32	142,60	139,81
34	151,52	148,73
36	160,43	157,64
38	169,34	166,55
40	178,25	175,46
44	169,08	193,29
48	213,90	211,11
54	249,55	246,76
64	285,20	282,41

STD8 OPEN-ENDED

SPIRAL CUT



STANDARD WIDTHS (mm)	10	12	15	20	25
Weight (gr/m)	55	66	83	110	138
Standard roll length and tolerance (m)	50 ± 5	40 ± 5	45 ± 5	50 ± 5	50 ± 5

Standard compound: **Chloroprene 74 ± 4 ShA**

Standard tooth cover: **nylon fabric**

Standard cord: **glass**

Standard width tolerance: **± 0,5 mm**

Standard thickness tolerance: **± 0,40 mm**

Standard length tolerance: **± 0,8 mm/m**

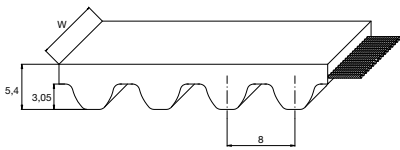

TRACTION RESISTANCE AND ELONGATION DATA

CALCULATION PARAMETERS

BELT WIDTH (mm)	BREAKING STRENGTH (N)
10	4200
12	5040
15	6650
20	7850
25	8690

BELT ELONGATION

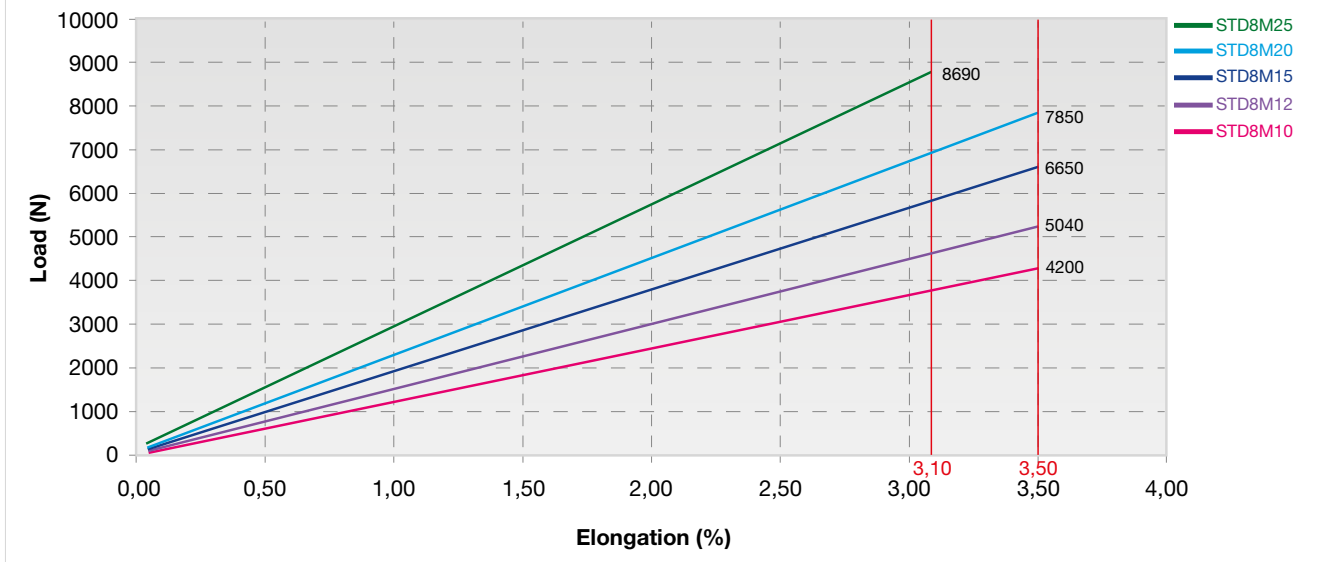

RUBBER OPEN-ENDED

STD8 OPEN-ENDED

SPIRAL CUT

TOOTH RESISTANCE

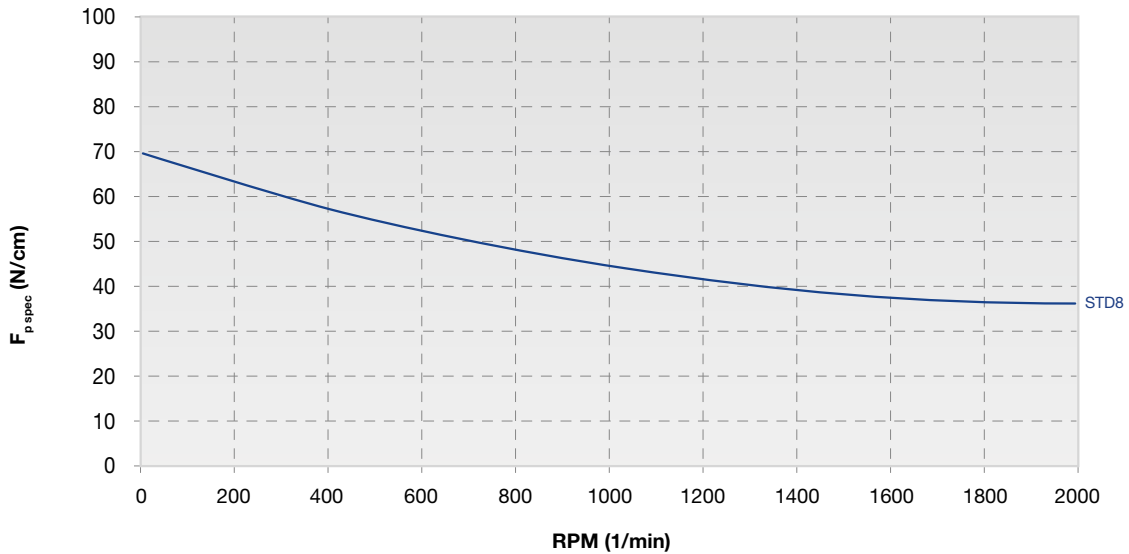

RPM (1/min)	0	10	50	100	200	500	1000	1500	2000
$F_{p\ spec}$ (N/cm)	70	69	65	63	61	54	44	38	36

Meshing Check is very suggested because of the belt's elasticity.

To safeguard the correct meshing it might be possible that Meshing Check leads to a wider belt.

FLEXION RESISTANCE

	z_{min}	z_{min} IDLER MIN DIA (mm)
Glass cords	22	22 100

PULLEYS

(FOR MORE DETAILS PLEASE SEE OUR PULLEY CATALOGUE)

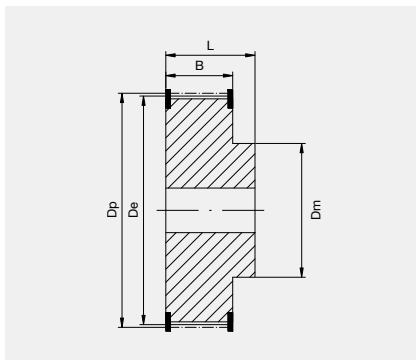

N° TEETH	DP	DE
22	56,02	54,62
24	61,12	59,72
26	66,21	64,81
28	71,30	69,90
30	76,39	74,99
32	81,49	80,09
34	86,58	85,18
36	91,67	90,27
38	96,77	95,37
40	101,86	100,46
44	112,05	110,65

N° TEETH	DP	DE
48	122,23	120,83
56	142,60	141,23
64	162,97	160,57
72	183,35	181,95
80	203,72	202,32
90	229,18	227,78
112	285,21	283,81
144	366,69	365,29
168	427,81	426,41
192	488,92	487,52

SPECIAL EXECUTION

FEASIBILITY

Megadyne can make special execution on customer's request to improve belt properties and to better suit special applications.

SUPER

On customer's request and with minimum quantity we can produce the belt with a double nylon fabric on teeth surface to improve torque carrying capacity.

The advantages are the following:

- Increased performance by approximately 10%
- Exceptional resistance to abrasion
- Low coefficient of friction
- Increased drive efficiency
- Increased belt and pulley life

SPECIAL CONSTRUCTIONS

On customer's request and with minimum quantity we can produce SILVER3 14M, GOLD2 5M, GOLD2 8M, and GOLD2 14M in open-ended version up to a width of 25 mm.

ANTISTATIC

On customer's request and with minimum quantity we can produce L, H, RPP5 and RPP8 belts in antistatic version (according to BS 2050). With minimum quantity Megadyne can also produce super-conductive belts overcoming ISO 9563 parameters.

HIGH TEMPERATURE

On customer's request and with minimum quantity we can produce special constructions.

SPECIAL BRANDING

On customer's request and with minimum quantity we can customize the belt's branding.

SPECIAL PACKAGING

On customer's request and with minimum quantity we can package the belts following some special indications.

SPECIAL WIDTH

On customer's request and with minimum quantity belts in special widths can be manufactured. For more information please check with our Application Department.

LOW NOISE

On customer's request and with minimum quantity we can produce soft compound belts to reduce noise problems. In this case the belt performance will decrease by approximately 10% compared to standard construction.

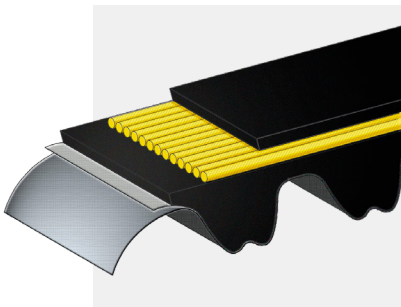

CLAMPING PLATES



The clamping plates are used to fasten the ends of the open belts. On the customer's request, the plates can be delivered with or without fixing holes. As the belt can't be stretched with clamping plates installed we suggest to use other tension system. The plates are delivered in aluminium alloy.

Contact Megadyne Application Engineering staff for assistance with special or particular applications.

ALUMINIUM

CLAMPING PLATES FOR IMPERIAL PITCH BELTS

Pitch	F	d	B	A	S	BELT WIDTH (INCHES)							
						025	037	050	075	100	150	200	300
						C							
XL*	6	5,5	3,5	42,5	8	25,5	28,5	32	-	-	-	-	-
L*	8	9	5	76,5	15	-	-	39	45	51,5	-	-	-
H*	10	11	9	106,9	22	-	-	45	51	57,5	70	83	108

*Available in customized length

ALUMINIUM

CLAMPING PLATES FOR HTD PITCH BELTS

Pitch	F	d	B	A	S	BELT WIDTH (MM)								
						9	10	15	20	25	30	40	50	55
						C								
5M*	6	5,5	3,25	41,5	8	28	-	34	-	44	-	-	-	-
8M*	8	9	5	66	15	-	35	40	45	-	55	-	75	-
14M*	10	11	9	106,9	22	-	-	-	-	56	-	71	-	86

*Available in customized length

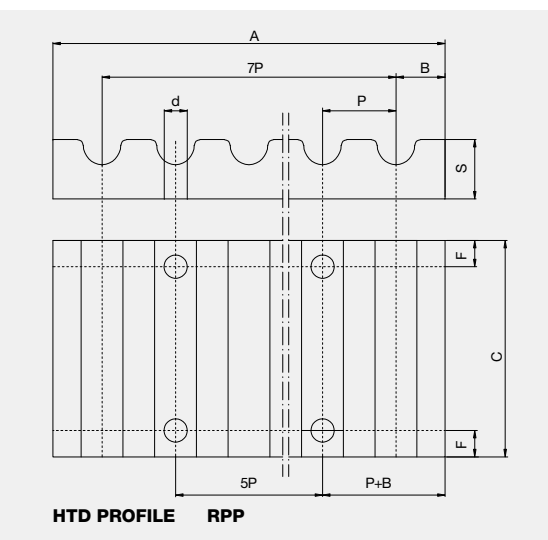
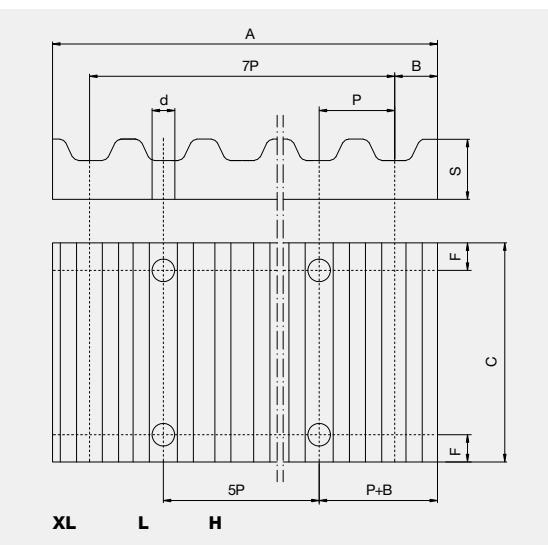

ORDER CODE EXAMPLE:

AT10 pitch clamping plate for 25 mm width belt.



USEFUL FORMULAS

AND CONVERSION TABLE

SPEED

$V = \frac{d_1 \cdot n_1}{19100}$	$n_1 = \frac{V \cdot 19100}{d_1}$	$d_1 = \frac{V \cdot 19100}{n_1}$
-----------------------------------	-----------------------------------	-----------------------------------

V : peripheral speed [m/s] | n_1 : rotation speed [RPM] | d_1 : pulley diameter [mm]

FORCES AND TORQUE

$F_u = \frac{19,1 \cdot 10^6 \cdot P}{d_1 \cdot n_1}$	$F_u = \frac{2000 \cdot M}{d_1}$	$F_u = \frac{P \cdot 10^3}{d_1}$
$M_t = \frac{P \cdot 9550}{n_1}$	$M_t = \frac{F_u \cdot d_1}{2000}$	$M_t = \frac{P \cdot d_1}{2 \cdot V}$

F_u : peripheral force [N] | M_t : drive torque [Nm] | P : power [kW]
 n_1 : rotation speed [RPM] | d_1 : pulley diameter [mm] | V : peripheral speed [m/s]

POWER

$P = \frac{F_u \cdot d_1 \cdot n_1}{19,1 \cdot 10^6}$	$P = \frac{M_t \cdot n_1}{9550}$	$P = \frac{F_u \cdot V}{1000}$
---	----------------------------------	--------------------------------

P : power [kW] | F_u : peripheral force [N] | M_t : drive torque [Nm]
 n_1 : rotation speed [RPM] | d_1 : pulley diameter [mm]

TO CONVERT FROM	TO	MULTIPLY BY
CV	HP	0,9863201
CV	kcal/h	63,24151
CV	W	735,4988
CV	kW	0,7354988
CV	kgf ⇔ m/s	75
CV	lbf ⇔ ft/s	542,476
HP	CV	1,01387
HP	kcal/h	641,1865
HP	W	745,6999
HP	kW	0,7456999
HP	kgf ⇔ m/s	76,04022
HP	lbf ⇔ ft/s	550
in	m	0,0254
in	cm	2,54
in	mm	25,4
in	ft	0,083
in ²	m ²	0,00064516
in ²	cm ²	6,4516
in ²	mm ²	645,16
in ²	ft ²	0,006944444
in ³	m ³	1,63871·10 ⁻⁵
in ³	cm ³	16,38706
in ³	mm ³	16387,06
in ³	ft ³	0,000578704
J	CV ⇔ h	3,77673·10 ⁻⁷

TO CONVERT FROM	TO	MULTIPLY BY
J	HP ⇔ h	3,72506·10 ⁻⁷
J	kWh	2,77778·10 ⁻⁷
kg	lb	2,204623
kgf	N	9,80665
kgf	lbf	2,204623
kgf ⇔ m/s	CV	0,01333333
kgf ⇔ m/s	W	9,80665
kgf ⇔ m/s	kW	0,00980665
kW	CV	1,359622
kW	kcal/h	859,8452
kW	W	1000
kW	kgf ⇔ m/s	101,9716
kW	lbf ⇔ ft/s	737,5621
lb	kg	0,4535924
lbf	kgf	0,4535924
lb	N	4,448222
N	kgf	0,1019716
N	lbf	0,2248089
W	CV	0,001359622
W	HP	0,001341022
W	kcal/h	0,8598452
W	kW	0,001
W	kgf ⇔ m/s	0,1019716
W	lbf ⇔ ft/s	0,7375621

DATA SHEET

CUSTOMER DATA

Company Name _____ Date _____

Address _____ Zip Code _____

City _____ State _____ Country _____

Customer Name/Surname _____

Office _____ Tel. _____ e-mail _____

DRIVE INFORMATION TRANSMISSION LAYOUT

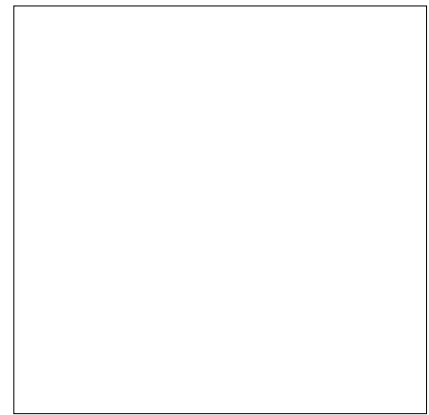
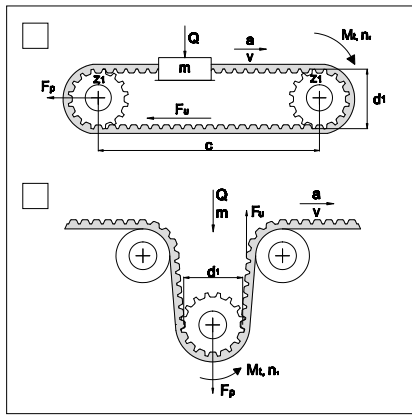
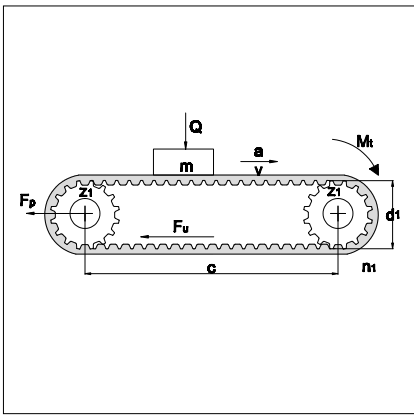

- Conveyor Linear motion (choose between the layout above) Other (If layout is different please sketch it above)

DRIVE INFORMATION (FOR CONVEYOR)

Driver pulley's diameter _____ Driven pulley's diameter _____

Center distance _____ Minimum safety factor needed _____

Are there any size limitation? Yes No

(if yes, please indicate *Max diameter*, *Max width* and *Max center distance*):

Max diameter _____ Max width _____ Max center distance _____

Linear speed _____ Acceleration _____ Mass _____

Is there any sliding surface? Yes No (if yes please indicate friction coefficient): _____

Is there any cover on the back? Yes No (if yes please indicate the type) _____

Are cleats required? Yes No (if yes please indicate cleats code, otherwise attach drawings) _____

Working time < 8h From 8h up to 16h 24h

DATA SHEET

DRIVE INFORMATION (FOR LINEAR MOTION)

Driver pulley's diameter _____ Driven pulley's diameter _____ Idler diameter _____

Center distance _____ Minimum safety factor needed _____

Are there any size limitation? Yes No

(if yes, please indicate *Max diameter*, *Max width* and *Max center distance*):

Max diameter _____ Max width _____ Max center distance _____

Linear speed _____ Acceleration _____ Mass _____

Working time < 8h From 8h up to 16h 24h

WORK'S ENVIRONMENT INFORMATION (FOR ALL LAYOUT TRANSMISSION SYSTEM)

Work Temperature (please indicate constant temperature and in case peaks) _____

Humidity Standard No standard Other _____

Chemical agents: (oils, grass, aggressive compounds) Yes No

In case please indicate type and percentage _____

MEGADYNE

The data and information contained in the present catalogue are updated to the date of the catalogue's printing. Ammega Italia S.p.A. reserves the right to modify the specifications, performances and other information relating to the belts described in the present catalogue, at any time at its own discretion, without any prior notice.

For updating refer to our website www.megadynegroup.com.

Technical specifications, performances and other information provided in the present catalogue are indicative and do not bound Ammega Italia S.p.A. unless such specifications, performances or other information are expressly agreed in the agreement with the customer.

We also recommend to read carefully the following documents on our web site www.megadynegroup.com:

- Ammega Italia S.p.A. General Conditions of Sale (comprising the warranty)
- Theoretical Belt Life.
- Drive Components: Storage, Installation, Maintenance and Troubleshooting Handbook
- belts standard use condition and temperature.

Copyright Notice: Ammega Italia S.p.A. copyright. All rights reserved.

Ammega Italia S.p.A. is and shall remain the owner of all rights on drawings, technical specifications and any other information contained in the present catalogue or otherwise communicated by Ammega Italia S.p.A. to the customer.

The customer shall not disclose such information to third parties or use such information for purposes different from the definition of the order to Ammega Italia S.p.A., unless upon prior written authorization of Ammega Italia S.p.A.



Discover Your Local Contacts

The local partner of choice
for sustainable power transmission belting solutions
around the globe.

General contact information:

Megadyne

Via Trieste, 16
Via S. Lucia 114 - 10075 Mathi (Torino)
Italy



Scan the QR code
and find your local
contact

megadynegroup.com/en/contact-us

