

EN

MEGALINEAR

TECHNICAL
HANDBOOK

INDEX

Introduction to open-ended belts	2	MTD3	66
Classifications	4	MTD5	68
Technical calculation	8	MTD8	70
Linear motion	10	MTD14	72
Conveyor belt	11	MTD14 XHP2	74
Calculation parameters	12	RPP5	76
Belt installation	14	RPP8	78
Belt data		RPP14	80
MXL	16	RPP14 XHP2	82
XL	18	STD5	84
L	20	STD8	86
H	22	HG	88
H WIDE	24	TG5	90
XH	26	TG10	92
T2,5	28	TG20	94
T5	30	ATG5	96
MegaEco Biobased T5	32	ATG10	98
T5 WIDE	34	ATG20	100
TT5 FOR KNITTING MACHINE	36	QST5	102
T10	40	QST8	104
MegaEco Biobased T10	42	QST14	106
T10 WITHOUT GAP	44	GW14	108
T10 WIDE	46	GW20	110
T20	48	FLAT	112
AT3	50	FC T5	114
AT5	52	FC T10	115
MegaEco Biobased AT5	54	Fixing plates	116
AT10	56	Positioning and transmission precision	119
MegaEco Biobased AT10	58	Cleats	120
AT10 WITHOUT GAP	60	Cover properties	134
MEGAC4T AT10	62	Special execution feasibility	136
AT20	64	Special execution photos	139
		Data sheet	140

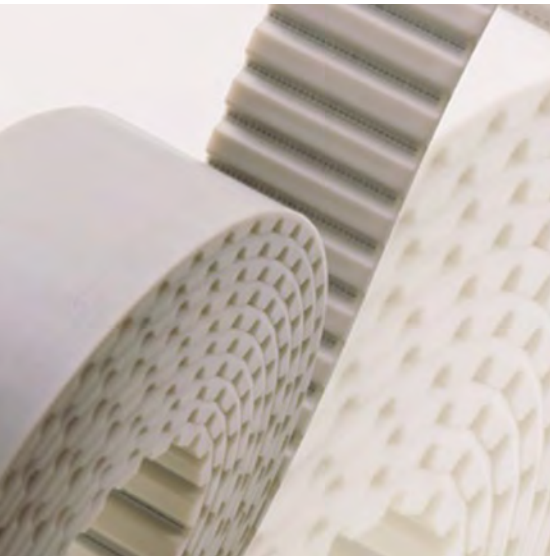

INTRODUCTION

TO OPEN-ENDED BELTS

Megadyne started manufacturing moulded transmission belts in 1957 and extruding open-ended belts in 1975. MEGALINEAR open length belts are manufactured in thermoplastic polyurethane, that gives superior wear and abrasion resistance. Various types of steel cord, offer good running characteristics, even under high tractive loads.

Advanced production processes, allow the ability to engineer bespoke technical design solutions to meet market demands. By selecting from a range of components and materials, MEGALINEAR belts can be manufactured to perform in even the most demanding applications. MEGALINEAR OPEN-ENDED belts are particularly suited where the most precise accuracy of position, low noise and long maintenance free cycles are the key requirements.

MEGADYNE HAS EXPANDED THE MEGALINEAR RANGE TO INCLUDE:

- MEGALINEAR QST
- MEGALINEAR GW
- MEGALINEAR FC - FCM - XMD
- MEGALINEAR MegaEco Biobased
- MEGALINEAR MEGAC4T™

MEGALINEAR QST

Uniquely designed to reduce the noise levels, generated during high speed operations, MEGALINEAR QST is completely self-tracking without the need for flanged pulleys. The nylon faced helical offset teeth design, provides a high torque capacity.

MEGALINEAR GW

For heavier applications, Megadyne have introduced the MEGALINEAR GW, a high performance thermoplastic polyurethane belt. Superior load capacities can be achieved due to the high shear strength of the tooth design, coupled with high tension, steel zinc coated cords, MEGALINEAR GW guarantees a greater transmittable power under continuous high loads.

MEGALINEAR FC

MEGALINEAR FC is a new range of belts of the MEGALINEAR family. Specifically introduced for the food processing industry, MEGALINEAR FC is manufactured with Food Contact approved materials, according to European regulations EU 1935/2004, EU 10/2011 and EU 174/2015. It's manufactured in T5/T10 pitches without nose gap between the teeth and available with a variety of backing profiles, for all kinds of conveying and processing applications. These advanced FDA synchronous belts have excellent resistance to chemicals and corrosion, certified for wet and dry food contact. The homogenous belt design ensures a significantly greater service life, with a high level of hygienic integrity.

MEGALINEAR FCM

On request and with minimum quantity, it's possible to produce MEGALINEAR FCM, made in sky blue colour (RAL 5012) and certified for direct contact with dry and wet food.

Both MEGALINEAR FC AND FCM can be made with a special Metal and X-Ray detectable compound. MEGALINEAR XMD decreases the risk of contamination from belt fragments protecting Consumer Safety.

MEGALINEAR MEGAECO BIOBASED

MEGALINEAR MegaEco Biobased is a part of the Megadyne MegaEco range, the sustainable belt solution for power transmission system. Made with polymer coming partially from vegetable sources, this "eco-friendly" belt can support companies to reduce CO2 footprint.



INTRODUCTION

TO OPEN-ENDED BELTS

MEGAC4T MEGALINEAR Adaptable Cleats For Transport - is the most versatile belt ever!

Its design with quick and easy interchangeable profiles means you can use the same belt for a wide variety of applications, transporting goods of different shapes on a single transport system with a minimum of downtime!

Thanks to their features, MEGALINEAR belts can be successfully used in a wide range of applications such as:

- Automatic sliding doors and garage opening system
- Elevators
- Automated handling devices
- Linear drivers
- Positioning system
- Wood industry
- Textile machine
- Serigraphic industry
- Glass industry
- Stone and marble industry
- Packaging industry
- Robot systems
- Tobacco industry
- Paper and carton industry
- Chemist and pharmaceutical industry
- Food industry

Megadyne has developed a very wide range of solutions with numerous tooth designs, tensile members and compound, suitable for all applications.

STANDARD RANGE

MXL • XL • L • H • XH

T2,5 • T5* • TT5 • T10* • T20

AT3 • AT5 • AT10 • MEGAC4TTM AT10 • AT20

MTD3 • MTD5 • MTD8 • MTD14 • MTD14 XHP2

RPP5 • RPP8 • RPP14 • RPP14XHP2

STD5 • STD8

HG • TG5 • TG10K6 • TG10K13 • TG20 • ATG5 • ATG10 • ATG20

QST5 • QST8 • QST14

GW14 • GW20

P1 • P2 • P3 • P4

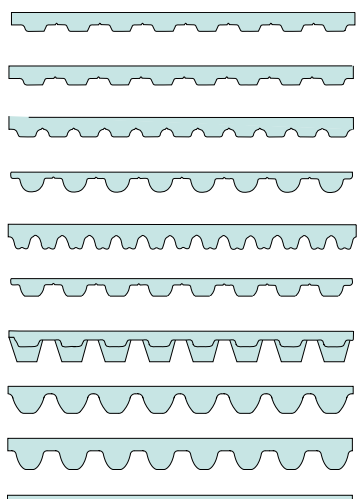

* Available in Food Contact (FC), X-Ray and Metal detectable (XMD) versions.

CLASSIFICATIONS

CLASSIFICATIONS



MEGALINEAR timing belts are manufactured in thermoplastic polyurethane, with single parallel steel cords. This type of belts, developed by our Research & Development, offers good running characteristics and high traction loads. They are especially suited for power transmission and conveying with high loads and speeds. The addition of a nylon coating on the teeth during production enhances the running properties for specific applications and reduces the noise due to a lower frictional coefficient. An extra thickness of special coating is also possible on the back of the belt offering extra protection against aggressive or heavy products.



- 1.** The body of the belts is white thermoplastic polyurethane 92 ShA, characterized by high levels of wear resistance even in the presence of shock and surge loading.
- 2.** High strength S and Z parallel zinked steel tension members allow high breaking load and extremely low elongation. The combination of these high grade materials improves belt performances which can be summarised as follows:
 - exceptional resistance to abrasion and tooth shear
 - low coefficient of friction
 - high flexibility
 - ozone and temperature resistance (-25 °C / +80 °C)
 - oil, grease and gasoline resistance

MECHANICAL AND CHEMICAL CHARACTERISTICS

- Constant dimensions
- Low pretension
- Noiseless
- Constant length
- Free maintenance
- High abrasion resistance
- High flexibility
- Ageing, hydrolysis, ozone resistant
- High resistance steel traction cords, with little stretching and top flexibility
- Working temperature -25 °C / +80 °C
- High resistance to oils, greases and gasoline
- Linear speeds up to 20 m/s
- Fairly Acid-proof and Alkali-proof constant dimensions



CLASSIFICATIONS

MECHANICAL AND CHEMICAL CHARACTERISTICS

BODY

MEGALINEAR belts are manufactured with white thermoplastic polyurethane 92 ShA as standard.

Special compounds (different hardnesses, special properties) are available on request. Special compound and cords have to be tested and homologated on the application. Megadyne is not responsible for wrong functioning of special products.

Here under some PU characteristics:

WATER

No problem in normal or sea clean water, at room temperature. Over 60 °C there is a fast decrement of breaking strength.

ACIDS

In acid diluted proportions, at room temperature, this PU is moderately attacked. In high concentration acid solutions, this PU has a very short lifespan. Over 50 °C, acids are always dangerous for thermoplastic PU.

ALKALIS

In alkalis diluted proportions, at room temperature, this PU is moderately attacked. In high concentration alkaline solutions, this PU has a very short lifespan. Over 50 °C, alkalis are always dangerous for thermoplastic PU.

SOLVENTS

Thermoplastic PU is insoluble in the greater part of solvents. Only the very polar solvents (same as tetrahydrofuran, dimethylformamide, n-methylpyrrolidone) can dissolve or tight damage PU. The esters or the ketons (same as ethyl acetate or methylethylketene) can usually produce a bulge, decreasing mechanical characteristics. The hydrocarbons aromatic and the hydrocarbons aliphatic produce very high bulge. All the effects increase by increasing temperature.

OILS

PU has a high resistance to mineral pure oils (lubricants, engine oils, combustible oils). Usually, high performance syntetic oils, due to special additives contained, can be incompatible with thermoplastic PU, especially at high temperature.

GREASES

PU has a high resistance to mineral pure greases (lubricants greases). Usually, high performance syntetic greases, due to special additives contained, can be incompatible with thermoplastic PU, especially at high temperature.

FUELS

Good resistance to petrols without alcohols. In presence of alcohols, thermoplastic PU can suffer deterioration. Fuels including aromatiche stuffs can produce reversible bulges.



CLASSIFICATIONS

MECHANICAL AND CHEMICAL CHARACTERISTICS

MICROORGANISMS

In presence of grime, containing humidity, Microorganisms can develop. In case that Microbic attack can produce danger, you have to use a special kind of PU.

WEATHER AGENTS

Good resistance to atmospheric agents. White colour can change to light yellow under long UV exposure. In any case this hasn't influence on mechanical resistance.

CORDS

STANDARD CORD

MEGALINEAR is manufactured with S and Z parallel zinked steel cords as standard.

KEVLAR

- Kevlar tension cords are suggested for:
 - Non magnetic, for use in drives with metal detectors
 - Widely used in the food industry
 - Applications in damp environment must be avoided
- Kevlar cord belts have a lower dimensional stability compared to steel cord belts. Length and tolerance may change.

HP

High Performance cords have 25% more strength capacity than standard cords. They are recommended for high repeatability applications.

HF

High Flexibility cords can accept smaller pulley and idler diameters than standard cords. They are suitable for multi-shaft drives with severe reverse bending.

HPF

High Performance and Flexibility cords have 25% more strength capacity like the HP cords, but they are more flexible than the HP cords. They are suggested for high performance and multi-shaft drives.

STAINLESS STEEL

Stainless steel cords have 25% less strength capacity than standard cords. They are recommended for water applications.



CLASSIFICATIONS

COATING

MEGALINEAR can be manufactured with special coating on the teeth or on the back. Please check on page 134 and 135.

IDENTIFICATION CODE

Using the information in the table below, it is possible to identify the correct belt for every application. The code is composed of letters and numbers as the following example:

1		2		3		4		5		6
J	+	50	+	AT	+	10	+	10000	+	SPECIAL MANUFACTURES

1	J	Joined belt.
	ML	MEGALINEAR belt OPEN-ENDED.
2	50	This number indicates the width of requested belt. The value is in mm for a belt with a pitch in mm, and in inches for a belt with a pitch in inches.
3	AT	This code composed by letters indicates the selection of profile.
4	10	This number indicates the standard pitch of the belt. It is expressed in mm.
5	10000	The last number indicates the length of the belt always in mm regardless of pitch.
6	SPECIAL MANUFACTURES	Special cords as Kevlar or HP or HF or HPF or stainless steel
		Special compound as different hardness 85 ShA or different colours (black - red - yellow - blue)
		Extra coating NFT or NFB or AVAFC or Tenax or Linatex or Honey Comb or PU black cellulose or PU yellow or Neoprene rubber.

TECHNICAL CALCULATION



OMEGA LINEAR MOTION BELT

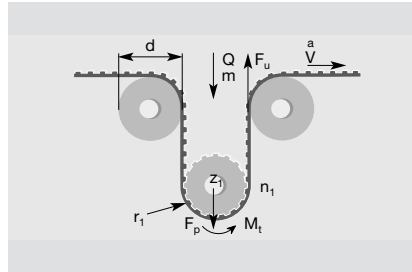

LINEAR MOTION AND CONVEYOR BELT

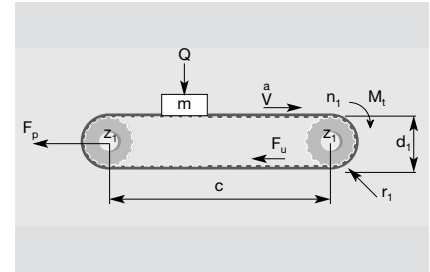

The following pages contain data, formulas and tables that are required to design a new belt drive. For critical and difficult drives, it is recommended that you contact our Application Department for advice.

SYMBOL	UNIT	DEFINITION	SYMBOL	UNIT	DEFINITION
a	m/s ²	ACCELERATION	g	m/s ²	GRAVITY (9,81)
b	mm	BELT WIDTH	μ	-	FRICTION COEFFICIENT
C	-	SAFETY FACTOR	m	Kg	CONVEYED MASS
Δl/∞	‰	ELONGATION	M_t	Nm	DRIVE TORQUE
d	mm	IDLER PITCH DIAMETERS	n₁	1/min	REVS/MIN (RPM) OF DRIVE SPROCKET 1
d₁	mm	SPROCKET PITCH DIAMETER	P	KW	DRIVE POWER
F_p	N	PRETENSION	Q	N	FORCE EXERTED BY MASS (M)
F_u	N	PERIPHERAL FORCE	V	m/s	BELT SPEED
F_{p spec}	N/cm	TRANSMITTABLE FORCE PER TOOTH PER UNIT WIDTH	Z_i		NUMBER OF TEETH OF SPROCKET
MTL	N	MAX TRACTION LOAD	Z_m		NUMBER OF TEETH IN MESH ON DRIVER SPROCKET (12)
BS	N	BREAKING STRENGTH	Z_L		NUMBER OF TEETH OF LARGE PULLEY
c	mm	CENTRE DISTANCE	Z_s		NUMBER OF TEETH OF SMALL PULLEY
			p		BELT PITCH

Max traction load is maximum acceptable traction on cords.
 Breaking strength is necessary load to break belt cords.
 Elongation is belt elongation under load.

USEFUL FORMULAS AND CONVERSION FACTORS

$$V = \frac{d_1 \cdot n_1}{19100}$$

$$n_1 = \frac{V \cdot 19100}{d_1}$$

$$d_1 = \frac{V \cdot 19100}{n_1}$$

$$Q = m \cdot g$$

$$P = \frac{M_t \cdot n_1}{9550}$$

$$M_t = \frac{9550 \cdot P}{n_1}$$

$$M_t = \frac{F_u \cdot d_1}{2000}$$



TECHNICAL CALCULATION

CHOICE OF BELT PITCH AND SPROCKETS

For optimum belt pitch see tables on page 12.
 For optimum choice of sprocket size, it is desirable to have as near to 12 teeth in mesh as possible.

Knowing mass	For horizontal & conveying drives <i>(Note: values of μ can be found in table 3 on page 13)</i>	$F_u = (m \cdot a) + (m \cdot g \cdot \mu)$
	For vertical drives	$F_u = (m \cdot a) + (m \cdot g)$
Knowing drive torque	-	$F_u = 2000 \text{ Mt} / d_1$
Knowing drive power	-	$F_u = 19.1 \cdot 10^6 \cdot P / (d_1 \cdot n_1)$

BELT WIDTH AND PROFILE ESTIMATION

The belt width b should be calculated using the following formula:

$b = (F_u \cdot c_s \cdot 10) / (F_{p \text{ spec}} \cdot Z_m)$	C_s	safety factor from page 11 table 4
	F_u	from above calculation
	Z_m	number of teeth in mesh on driver sprocket
		$[0.5 - \frac{4 \cdot p}{79 \cdot c} (Z_L - Z_d)] \cdot Z_s$
	Z_m	(if calculated $Z_m > = 12$ for an OPEN-ENDED application use $Z_m = 12$) (if calculated $Z_m > = 6$ for a joined application use $Z_m = 6$)
	F_{p spec}	transmittable force per tooth per unit width (see table on belt data pages)

PRE-TENSIONING

The suggested installation tension:

F_p	$2 \cdot F_u$ for linear and omega linear movement applications
F_p	F_u for conveyor applications

CORD CHECK

The maximum allowable tensile load of the belt pitch/width combination selected (see tables on belt data pages):

$$\text{max traction load of chosen belt} > \frac{F_p}{2} + (F_u \cdot C_s)$$

SPROCKET AND IDLER DIAMETER CHECK

Ensure that all selected pulley and idler diameters are equal to or greater than the minimum values specified in corresponding belt data page.

ELONGATION

When the belt is operating there will be an elongation proportional to max traction load:

$$\Delta l / l_0 = (F_u \cdot 4) / \text{max traction load}$$



LINEAR MOTION

CALCULATION EXAMPLE (OPEN-ENDED BELT)

CHOICE OF BELT PITCH AND SPROCKETS

According to the belt pitch selection table n.1 on page 12 considering the values of P and n₁, we select RPP8 belt.

Then we consider the pulley diameter nearest to the requested value and the corresponding n. of teeth (see technical information on page 79).

Therefore Z₁ = 30 teeth (with a pitch diameter of 76,4 mm).

CALCULATION OF THE EFFECTIVE TENSION

Since the drive power is known, F_u can be calculated

$$F_u = \frac{19,1 \cdot 10^6 \cdot P}{d_1 \cdot n_1} = \frac{19,1 \cdot 10^6 \cdot 1,8}{76,4 \cdot 300} = 1500 \text{ N}$$

DETERMINATION OF THE BELT WIDTH

$$b = \frac{F_u \cdot C_s \cdot 10}{F_{p \text{ spec}} \cdot Z_m}$$

$$b = \frac{1500 \cdot 1,4 \cdot 10}{62 \cdot 12} = 28,2 \text{ mm}$$

F_u	from before (1500 N)
C_s	from page 13 table 4, for low fluctuating load C _s = 1,4
Z_m	given that driver pulley has 30 teeth and n. of teeth in mesh 15 but max Z _m is 12, then Z _m = 12
n₁	300 RPM (given)
F_{p spec}	62N / cm (refer page 78 at 300 RPM)

Since the next closest width is 30 mm: 30 RPP8 is chosen.

PRE-TENSIONING

$$F_p = 2 \cdot F_u$$

$$F_p = 3000 \text{ N}$$

CORD CHECK

From page 78, RPP8 pitch 30 mm wide: max traction load 4750 N

$$\text{max traction load} > \frac{F_p}{2} + (F_u \cdot C_s)$$

$$\frac{F_p}{2} + (F_u \cdot C_s) = 1500 + 1500 \cdot 1,4$$

4750 N > 3600 N selected belt is acceptable.

SPROCKET AND IDLER DIAMETER CHECK

Ensure that all selected pulley and idler diameters are greater than or equal the minimum values specified on page 79.

ELONGATION

$$\Delta l_{\infty} = \frac{F_u \cdot 4}{\text{max traction load}} = \frac{1500 \cdot 4}{4750} = 1,26 \text{ mm/m}$$

In the dynamic situations you will have an elongation of 1,26 mm per meter of operating belt.

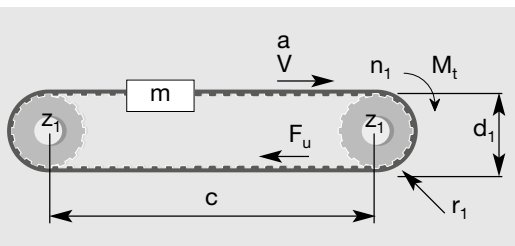

MACHINE DATA

C = 2.000 mm
d₁ = 76 mm
n₁ = 300 RPM
P = 1,8 KW
low fluctuating load



CONVEYOR BELT

CALCULATION EXAMPLE (JOINED BELT)

CHOICE OF BELT PITCH AND SPROCKETS

According to the belt selection table n. 2 on page 12, considering the values of F_u (for joined belts enter double of calculated F_u in table 2), we select T 10. Then we consider the pulley diameter nearest to the requested value and the corresponding n. of teeth (see technical information page 41). Therefore $Z_1 = 32$ teeth (with a pitch diameter of 101,86 mm).

CALCULATION OF THE EFFECTIVE TENSION

Since the mass is known, F_u can be calculated

$$F_u = (m \cdot a) + (m \cdot g \cdot \mu) \quad | \text{value of } \mu \text{ according to table 3 on page 13} = 0,35$$

$$F_u = (460 \cdot 0,5) + (460 \cdot 9,81 \cdot 0,35) = 1810 \text{ N}$$

$$m = Q/g = 4500 / 9,81 = 460 \text{ kg}$$

DETERMINATION OF THE BELT WIDTH

$b = \frac{F_u \cdot C_s \cdot 10}{F_{p \text{ spec}} \cdot Z_m}$	F_u	from before (1810 N)
	C_s	from page 13 table 4, for low fluctuating load $C_s = 1,4$
$b = \frac{1810 \cdot 1,4 \cdot 10}{45 \cdot 6} = 93,85 \text{ mm}$	Z_m	given that driver pulley has 32 teeth and n. of teeth in mesh 16 but max Z_m is 6, then $Z_m = 6$
	n_1	$(V_p \cdot 60.000) / (\pi \cdot d_1) = (0,5 \cdot 60.000) / (\pi \cdot 101,86)$ as $d_1 = 101,86$ from before = 94 RPM
	$F_{p \text{ spec}}$	45 N / cm (refer page 40, at 100 RPM)

Since the next closest width is 100 mm: 100 T10 is chosen.

PRE-TENSIONING

$F_p = F_u$	$F_p = 1810 \text{ N}$
-------------	------------------------

CORD CHECK

From page 40, T10 pitch 100 mm wide joined: max traction load 5415 N

$\text{max traction load} > F_p + (F_u \cdot C_s)$	$F_p + (F_u \cdot C_s) = 1810 + (1810 \cdot 1,4)$
--	---

5415 N > 4344 N selected belt is acceptable.

SPROCKET AND IDLER DIAMETER CHECK

Checking technical data on page 41 for pulley and idlers, it can be seen that the drive has acceptable pulley diameters.

ELONGATION

$$\Delta W_{00} = \frac{F_u \cdot 4}{\text{max traction load}} = \frac{1810 \cdot 4}{5415} = 1,33 \text{ mm/m}$$

In the dynamic situations you will have an elongation of 1,33 mm per meter of operating belt.

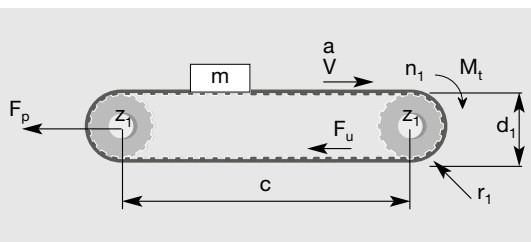

MACHINE DATA

- C = 5.000 mm
- d₁ = 100 mm
- V = 0,5 m/s
- a = 0,5 m/s²
- Guide in nylon
- Q = 4500 N
- low fluctuating load



CALCULATION PARAMETERS

BELT PITCH SELECTION

TABLE 1

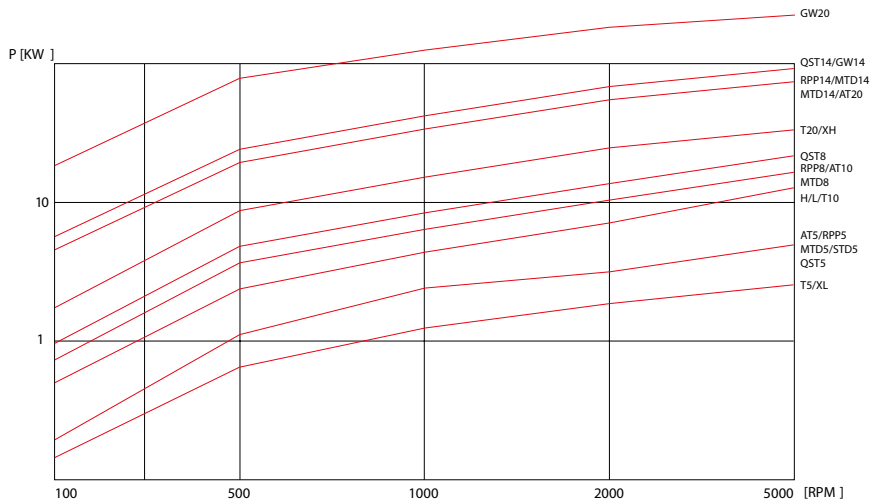

BELT WIDTH SELECTION

TABLE 2

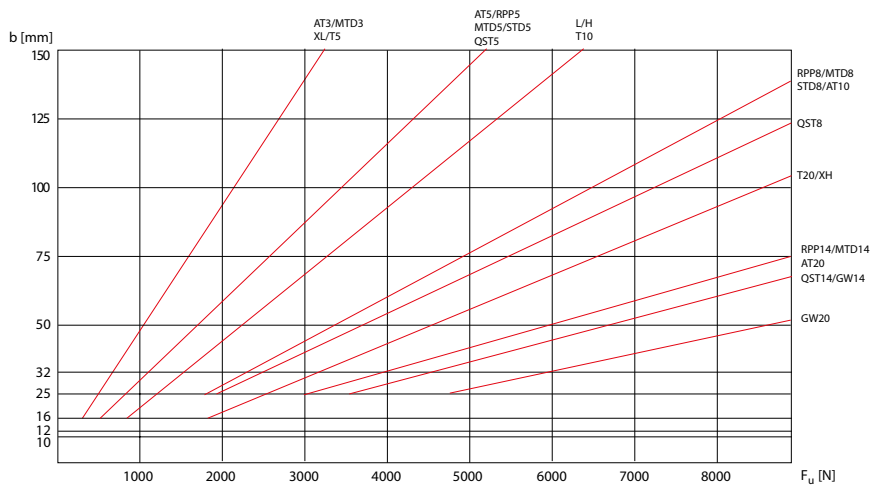

Average values valid for standard steel cord. After belt selection, please check belt resistance on belt data page.



CALCULATION PARAMETERS

TABLE 3 - FRICTION COEFFICIENT

Sliding friction on dry surface	polyurethane / smooth steel	$\mu = 0,5$
	polyurethane / rough steel	$\mu = 0,7$
	polyurethane / abrasive steel	$\mu = 0,9$
	polyurethane NFT / smooth steel	$\mu = 0,25$
	polyurethane NFT / rough steel	$\mu = 0,35$
	polyurethane NFT / abrasive steel	$\mu = 0,6$
	polyurethane / nylon	$\mu = 0,35$
	polyurethane NFT / nylon	$\mu = 0,15$
	polyurethane / aluminium	$\mu = 0,8$
Rolling friction on dry surface	polyurethane NFT / aluminium	$\mu = 0,45$
	Bearing	$\mu = 0,015$
	Roller / PU Belt	$\mu = 0,03 / 0,06$
	Bush	$\mu = 0,15$

The choice of the Safety factor's, depends on the operating conditions.

The following table shows the value to be used:

TABLE 4 - SAFETY FACTOR

Steady Load		1
Shock Load	Low	1,4
	Average	1,7
	High	2
Elevators, hoists		1,8
Line shafts		1,6
Paper machines	Agitators, calenders, driers, winding frames,	1,6
	Willows, jordan machines, pumps, slicers, grinders	1,8
Machines for pottery and earthenware	Cutters, granulators,	1,7
	Pulping machines	2
Laundry machines	General	1,6
	Extractors, washers	1,8
Machines for rubber processing		1,8
Woodworking machines:	Lathes, band saws, cutters,	1,7
	Circular saws, planers, jointer	1,7
Printing machinery	Rotary, newspaper, linotype, cutters, folders, magazine	1,6
Textile machines	Warping machines, winders,	1,7
	Spinners, twisting frames, looms	1,8
Machines tools	Drilling machines, lathes, tread cutting machines, gears cutters, boring machines	1,6
	Millers, planers,	1,7
	Grinding machines	1,7
Conveyors	Hoists, light package	1,3
	Oven screw flight, apron bucket, elevator, screw	1,8
Brick machinery		1,8

BELT INSTALLATION



SKETCH KEYS

- F_p = pretension
- F_u = peripheral force
(see calculation pag. 10/11)
- r = pulley radius

A major difficulty installing transmission belt is to achieve correct belt tension. Lifetime of support bearings and transmission belts and therefore reliability of the complete system largely depends on an optimally adjusted belt tension.

Pretension is the force needed to put tension into the system to avoid the belt jumping on the pulleys as in the example as in the sketch A.

For a correct system installation, all applications with MEGALINEAR belt can be summarised according sketches B and C.

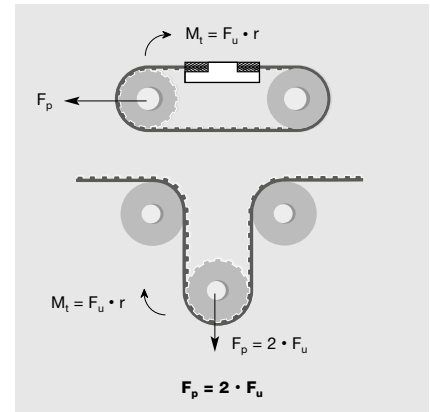

Linear and omega motion belt. Sketch B

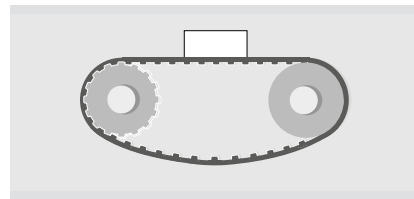

Not correct belt installation.

Sketch A

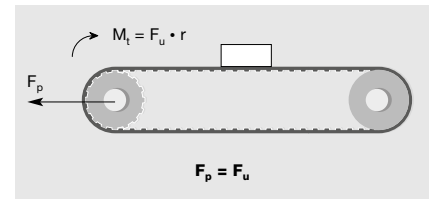

Conveyor belt. Sketch C

PROCEDURE TO MEASURE

The procedure to measure the tension of the belt is to use a Belt Tension Gauging Equipment. This device consists of a small sensing head which is held across the belt to be measured. The belt is then tapped to induce the belt to vibrate at its natural frequency. The vibrations are detected and the frequency of vibration is then displayed on the measuring unit.

The relation between belt static tension (T_s) and frequency of vibration (f) may be calculated using the following formula:

$$f = \frac{1}{2t} \cdot \sqrt{\frac{T_s}{m}} \quad \text{or} \quad T_s = 4 \cdot m \cdot t^2 \cdot f^2$$

WHERE :

T_s = static tension (N)	f = Frequency of vibration in Hertz (Hz)
m = Belt mass per unit length (kg/m)	t = Free belt span length in meters (m)



BELT INSTALLATION

For a correct system functioning and to increase belt life, it is necessary a correct pulley installation: pulleys has to be parallel and aligned as shown in drawing 1 (correct configuration).

If pulleys are not parallel as in drawing 2, belt could fall during functioning and this can provoke damages to complete equipment.

To grant a correct belt running, α and Δx must be as smaller as possible. For more information, please contact our technical staff.

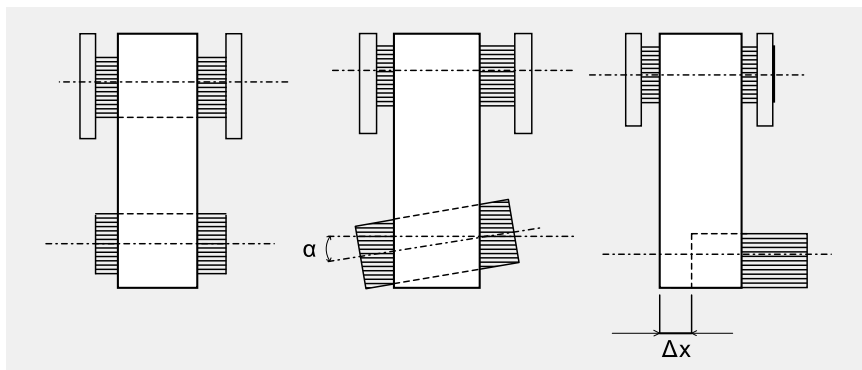

Drawing 1

Drawing 2

Drawing 3

In omega application to grant good mesh between pulley and teeth and to respect belt flexibility avoiding excessive stress on cords, distance d (as Drawing 4) has to be:

$$d = 4 \cdot \text{belt width}$$

Suggested angle 120°

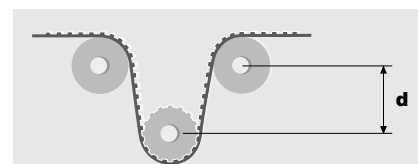

Moreover for a good drive work, it is suggested to check belt straightness as follows:

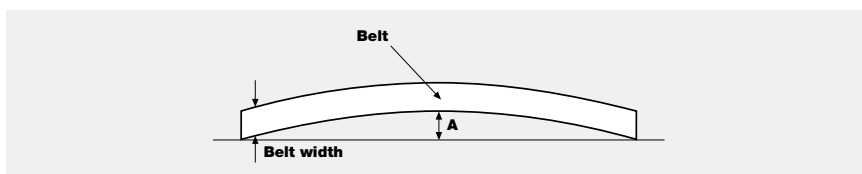

BELT WIDTH	TESTING BELT LENGTH	MAXIMUM SUGGESTED BENDING (A)
Till to 20 mm	1 m	3 mm
Over 20 mm	2 m	4 mm

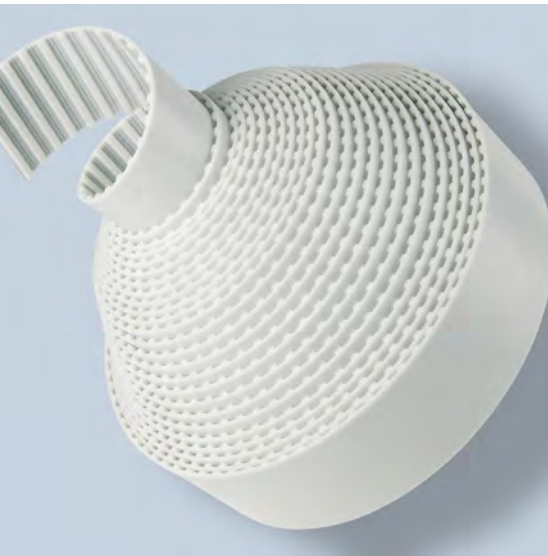

MEGALINEAR

MXL OPEN-ENDED

STANDARD WIDTHS (inch)	017	037	050
STANDARD WIDTHS (mm)	4,318	9,53	12,7
Weight (gr/m)	8	16	24

Standard compound:	white polyurethane thermoplastic 92 ShA
Standard back cover:	none
Standard tooth cover:	none
Standard cords:	S and Z torsion kevlar cords
Standard width tolerance:	+/- 0,38 mm
Standard thickness:	1,14 +/- 0,13 mm
Standard length tolerance:	+/- 0,8 mm/m
Standard roll length:	100 m
Belt options on request with minimum quantity:	Antistatic compound

TOOTH PROFILE ACCORDING TO ISO 5296-1

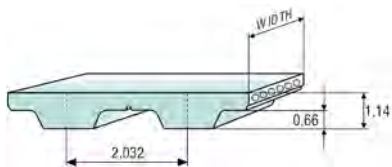

TOOTH RESISTANCE

RPM (1/min)	0	20	40	60	80	100	200	300	400	500	750	1000	1500	2000	3000	4000
F _{p spec} (N/cm)	7,3	7	6,8	6,7	6,6	6,4	5,9	5,7	5,4	5,2	4,9	4,6	4,2	4	3,6	3,25

Minimum suggested number of teeth in clamp for linear movement: 7

TRACTION RESISTANCE

CORD MATERIAL	BELT WIDTH (INCH)	017	037	050
Kevlar	Max Traction Load (N)	240	450	600
	Breaking Strength (N)	960	1800	2405
	Elongation at MTL (mm/m)	8	8	8

Average values



MEGALINEAR

MXL OPEN-ENDED

FLEXION RESISTANCE

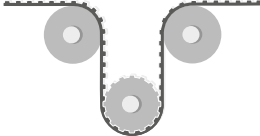
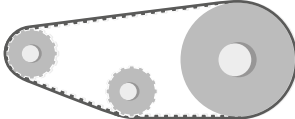
			
	Z_{MIN}	Z_{MIN} IDLER MIN DIA (MM)	Z_{MIN} IDLER MIN DIA (MM)
Kevlar cords	12	15 30	12 20

PULLEYS

(FOR MORE DETAILS PLEASE SEE OUR PULLEYS CATALOGUE)

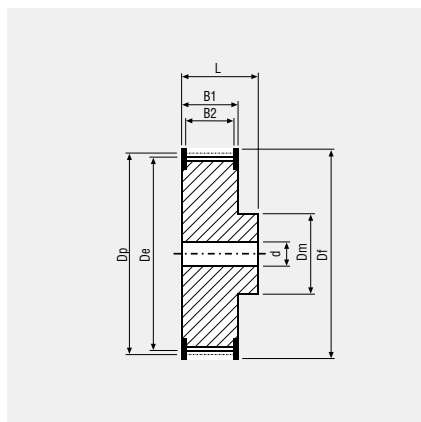

N° TEETH	DP	DE
10	6,47	5,96
12	7,76	7,25
13	8,41	7,90
14	9,06	8,55
15	9,70	9,19
16	10,35	9,84
17	11,00	10,49
18	11,64	11,13
19	12,29	11,78
20	12,94	12,43
21	13,58	13,07
22	14,23	13,72
24	15,52	15,01

N° TEETH	DP	DE
26	16,81	16,30
28	18,11	17,60
30	19,40	18,89
32	20,70	20,19
34	21,99	21,48
36	23,29	22,78
40	25,87	25,36
42	27,17	26,66
44	28,46	27,95
48	31,05	30,54
60	38,81	38,30
65	42,04	41,53
72	46,57	46,06

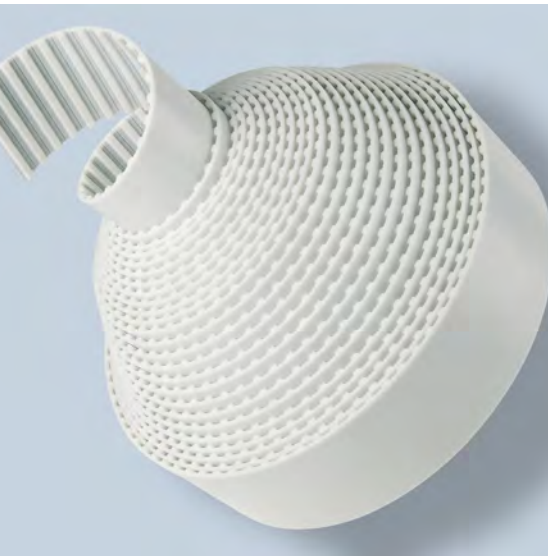

MEGALINEAR

XL OPEN-ENDED

STANDARD WIDTHS (inch)	025	037	050	075	100	150	200
STANDARD WIDTHS (mm)	6,35	9,53	12,7	19,05	25,4	38,1	50,8
Weight (gr/m)	15	20	30	45	60	90	120

Standard compound	white polyurethane thermoplastic 92 ShA
Standard back cover	none
Standard tooth cover	none
Standard cords	S and Z torsion zinked steel
Standard width tolerance	+/- 0,5 mm
Standard thickness	2,3 +/- 0,3 mm
Standard length tolerance	+/- 0,8 mm/m
Standard roll length	100 m

Belt options on request with minimum quantity	Nylon fabric back Nylon fabric teeth Antistatic nylon fabric Transparent FDA compound AVAFC 60/70/85 ShA APL Cleats
---	--

TOOTH PROFILE ACCORDING TO ISO 5296-1

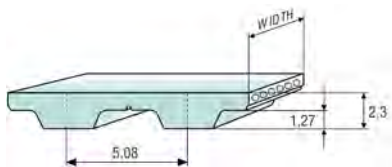

Different back coating materials see page 134

TOOTH RESISTANCE

RPM (1/min)	0	20	40	60	80	100	200	300	400	500	750	1000	1500	2000	3000	4000	5000	8000
F _{p spec} (N/cm)	19	19	18	18	17	17	16	15	15	14	13	13	12	11	10	9	8	7

Minimum suggested number of teeth in clamp for linear movement: 7

TRACTION RESISTANCE

CORD MATERIAL	BELT WIDTH (INCH)	025	037	050	075	100	150	200
Steel	Max Traction Load (N)	155	250	375	625	840	1310	1750
	Breaking Strength (N)	625	1000	1500	2500	3375	5250	7000
	Elongation at MTL (mm/m)	4	4	4	4	4	4	4
Kevlar	Max Traction Load (N)	230	370	560	935	1260	1965	2755
	Breaking Strength (N)	935	1495	2245	3740	5050	7860	10480
	Elongation at MTL (mm/m)	8	8	8	8	8	8	8
Stainless	Max Traction Load (N)	125	205	305	515	695	-	-
	Breaking Strength (N)	515	820	1235	2060	2780	-	-
	Elongation at MTL (mm/m)	3,8	3,8	3,8	3,8	3,8	-	-

Average values



MEGALINEAR

XL OPEN-ENDED

FLEXION RESISTANCE

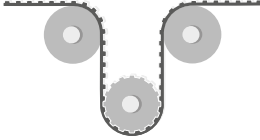
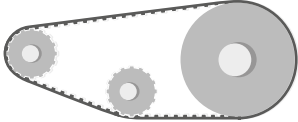
			
	Z_{MIN}	Z_{MIN} IDLER MIN DIA (MM)	Z_{MIN} IDLER MIN DIA (MM)
Standard steel cords	10	15 30	10 30
Kevlar cords	10	15 30	10 20
Stainless steel cords	13	15 35	13 35

JOINED BELT INFORMATION:

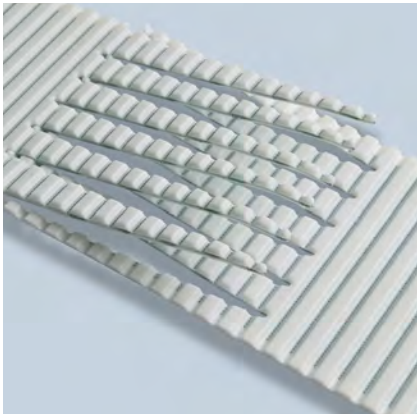

- Minimum splice length 900 mm
- Traction and tooth resistances = 50% less than open-ended
- Joined belt can be used only in conveyor systems
- Rolls with NFT, NFB, AVAFC and APL can be joined too
- Minimum diameters according above table
- For coated belts, minimum diameters on page 134

PULLEYS

(FOR MORE DETAILS PLEASE SEE OUR PULLEYS CATALOGUE)

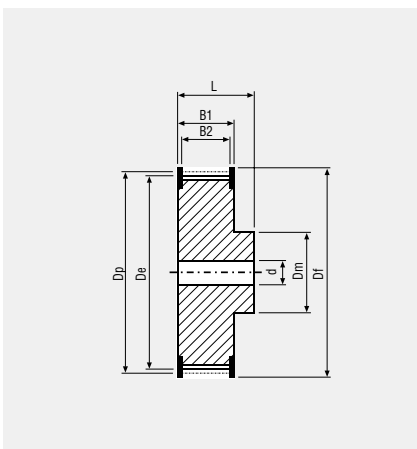

N° TEETH	DP	DE	N° TEETH	DP	DE
10	16,17	15,66	26	42,04	41,53
11	17,79	17,28	27	43,67	43,16
12	19,40	18,89	28	45,28	44,77
13	21,02	20,51	29	46,89	46,38
14	22,64	22,13	30	48,51	48,00
15	24,26	23,75	32	51,74	51,23
16	25,87	25,36	34	54,98	54,47
17	27,49	26,98	35	56,60	56,09
18	29,11	28,60	36	58,21	57,70
19	30,72	30,21	38	61,45	60,94
20	32,34	31,83	39	63,06	62,55
21	33,96	33,45	40	64,68	64,17
22	35,57	35,07	42	67,91	67,40
24	38,81	38,30	44	71,15	70,64

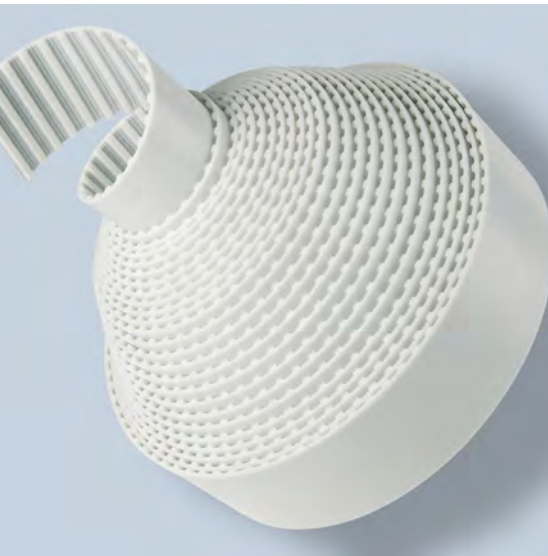

MEGALINEAR

L OPEN-ENDED

STANDARD WIDTHS (inch)	037	050	075	100	150	200	400
STANDARD WIDTHS (mm)	9,53	12,7	19,05	25,4	38,1	50,8	101,6
Weight (gr/m)	35	45	65	90	135	180	325

Standard compound	white polyurethane thermoplastic 92 ShA
Standard back cover	none
Standard tooth cover	none
Standard cords	S and Z torsion zinked steel
Standard width tolerance	+/- 0,5 mm
Standard thickness	3,6 +/- 0,3 mm
Standard length tolerance	+/- 0,8 mm/m
Standard roll length	100 m

Belt options on request with minimum quantity	Nylon fabric back Nylon fabric teeth Antistatic nylon fabric Transparent FDA compound AVAFC 60/70/85 ShA APL Cleats
---	--

TOOTH PROFILE ACCORDING TO ISO 5296-1

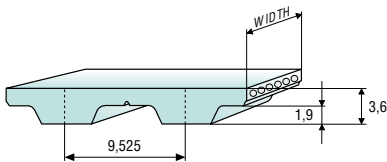

Different back coating materials see page 134

TOOTH RESISTANCE

RPM (1/min)	0	20	40	60	80	100	200	300	400	500	750	1000	1500	2000	3000	4000	5000	8000
F _{p spec} (N/cm)	37	36	35	35	34	33	31	29	28	27	24	23	20	19	16	15	13	11

Minimum suggested number of teeth in clamp for linear movement: 7

TRACTION RESISTANCE

CORD MATERIAL	BELT WIDTH (INCH)	037	050	075	100	150	200	400
Steel	Max Traction Load (N)	600	800	1340	1805	2810	3750	7500
	Breaking Strength (N)	2410	3215	5360	7235	11255	15005	26260
	Elongation at MTL (mm/m)	4	4	4	4	4	4	4
Kevlar	Max Traction Load (N)	740	985	1645	2225	3460	4860	9230
	Breaking Strength (N)	2965	3955	6595	8900	13850	18465	32320
	Elongation at MTL (mm/m)	8	8	8	8	8	8	8
Stainless	Max Traction Load (N)	530	705	1180	1590	-	-	-
	Breaking Strength (N)	2120	2830	4724	6370	-	-	-
	Elongation at MTL (mm/m)	3,8	3,8	3,8	3,8	-	-	-

Average values



MEGALINEAR

L OPEN-ENDED

FLEXION RESISTANCE

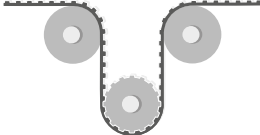
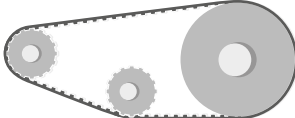
			
	Z_{MIN}	Z_{MIN} IDLER MIN DIA (MM)	Z_{MIN} IDLER MIN DIA (MM)
Standard steel cords	15	20 60	15 60
Kevlar cords	15	20 60	15 60
Stainless steel cords	18	20 65	18 65

JOINED BELT INFORMATION:

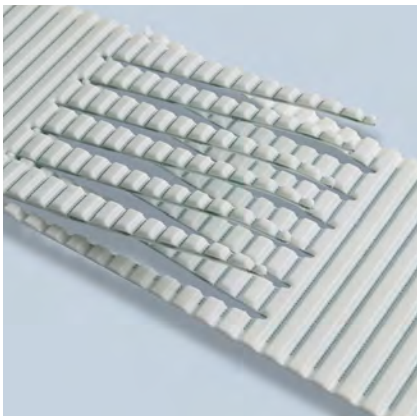

- Minimum splice length 900 mm
- Traction and tooth resistances = 50% less than open-ended
- Joined belt can be used only in conveyor systems
- Rolls with NFT, NFB, AVAFC and APL can be joined too
- Minimum diameters according above table
- For coated belts, minimum diameters on page 134

PULLEYS

(FOR MORE DETAILS PLEASE SEE OUR PULLEYS CATALOGUE)

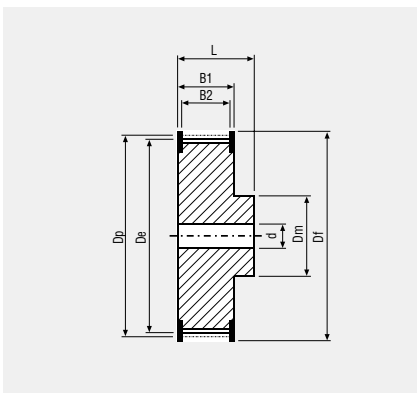

N° TEETH	DP	DE
15	45,48	44,72
16	48,51	47,75
17	51,54	50,78
18	54,57	53,81
19	57,61	56,85
20	60,64	59,88
21	63,67	62,91
22	66,70	65,94
23	69,73	68,97
24	72,77	72,01
25	75,80	75,04
26	78,83	78,07

N° TEETH	DP	DE
27	81,86	81,10
28	84,89	84,13
29	87,93	87,17
30	90,96	90,20
32	97,02	96,26
34	103,08	102,32
36	109,15	108,39
40	121,28	120,52
44	133,40	132,64
48	145,53	144,76
56	169,79	169,03

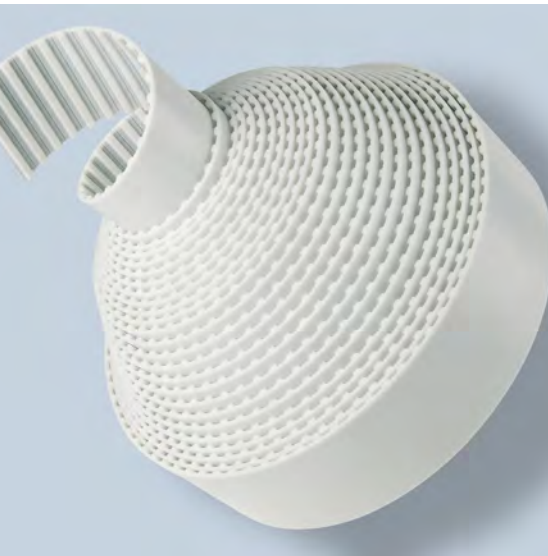

MEGALINEAR

H OPEN-ENDED

STANDARD WIDTHS (inch)	050	075	100	150	200	300	400	600
STANDARD WIDTHS (mm)	12,7	19,05	25,4	38,1	50,8	76,2	101,6	152,4
Weight (gr/m)	55	80	110	160	215	325	430	645

Standard compound	white polyurethane thermoplastic 92 ShA
Standard back cover	none
Standard tooth cover	none
Standard cords	S and Z torsion zinked steel
Standard width tolerance	+/- 0,5 mm
Standard thickness	4,3 +/- 0,3 mm
Standard length tolerance	+/- 0,8 mm/m
Standard roll length	100 m

Belt options on request with minimum quantity	Nylon fabric back Nylon fabric teeth Antistatic nylon fabric Transparent FDA compound AVAFC 60/70/85 ShA APL Cleats
---	--

TOOTH PROFILE ACCORDING TO ISO 5296-1

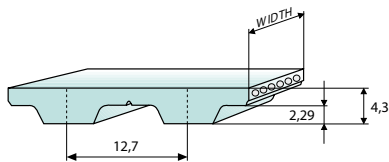

Different back coating materials see page 134

TOOTH RESISTANCE

RPM (1/min)	0	20	40	60	80	100	200	300	400	500	750	1000	1500	2000	3000	4000	5000	8000
F _{p spec} (N/cm)	44	43	42	41	40	39	36	34	33	31	29	27	24	22	19	17	16	12

Minimum suggested number of teeth in clamp for linear movement: 7

TRACTION RESISTANCE

CORD MATERIAL	BELT WIDTH (INCH)	050	075	100	150	200	300	400	600
Steel	Max Traction Load (N)	1050	1785	2415	3675	5040	8065	11760	12480
	Breaking Strength (N)	4200	7140	9660	14700	20160	30660	41160	43680
	Elongation at MTL (mm/m)	4	4	4	4	4	4	4	4
Kevlar	Max Traction Load (N)	915	1570	2095	3270	4685	7165	10475	15560
	Breaking Strength (N)	3665	6285	8380	13095	17805	27235	36665	54475
	Elongation at MTL (mm/m)	8	8	8	8	8	8	8	8
Stainless	Max Traction Load (N)	950	1615	2190	3330	4570	-	-	-
	Breaking Strength (N)	3810	6475	8760	13335	18285	-	-	-
	Elongation at MTL (mm/m)	3,8	3,8	3,8	3,8	3,8	-	-	-

Average values



MEGALINEAR

H OPEN-ENDED

FLEXION RESISTANCE

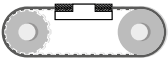
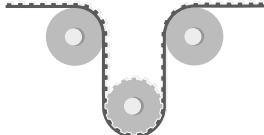
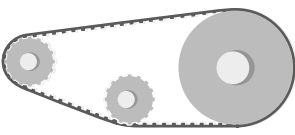
			
	Z_{MIN}	Z_{MIN} IDLER MIN DIA (MM)	Z_{MIN} IDLER MIN DIA (MM)
Standard steel cords	14	20 80	14 60
Kevlar cords	14	20 80	14 60
Stainless steel cords	18	20 80	18 65

JOINED BELT INFORMATION:

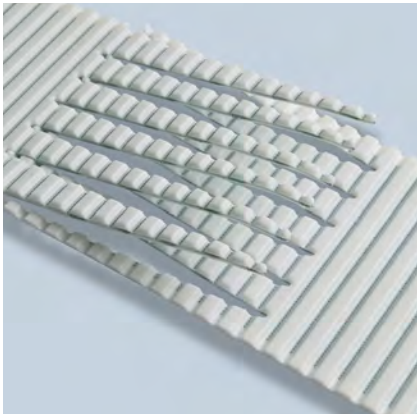

- Minimum splice length 900 mm
- Traction and tooth resistances = 50% less than open-ended
- Joined belt can be used only in conveyor systems
- Rolls with NFT, NFB, AVAFC and APL can be joined too
- Minimum diameters according above table
- For coated belts, minimum diameters on page 134

PULLEYS

(FOR MORE DETAILS PLEASE SEE OUR PULLEYS CATALOGUE)

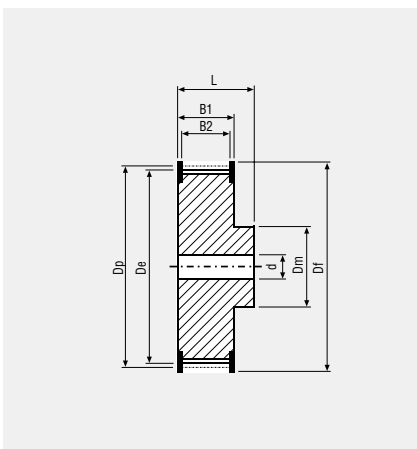

N° TEETH	DP	DE	N° TEETH	DP	DE
14	56,60	55,23	28	113,19	111,82
15	60,64	59,27	29	117,23	115,86
16	64,68	63,31	30	121,28	119,91
17	68,72	67,35	32	129,36	127,99
18	72,77	71,40	33	133,40	132,03
19	76,81	75,44	34	137,45	136,08
20	80,85	79,48	35	141,49	140,12
21	84,89	83,52	36	145,53	144,16
22	88,94	87,57	38	153,62	152,25
23	92,98	91,61	40	161,70	160,33
24	97,02	95,65	44	177,87	176,50
25	101,06	99,69	48	194,04	192,67
26	105,11	103,74	52	210,21	208,84
27	109,15	107,78	60	242,55	241,18

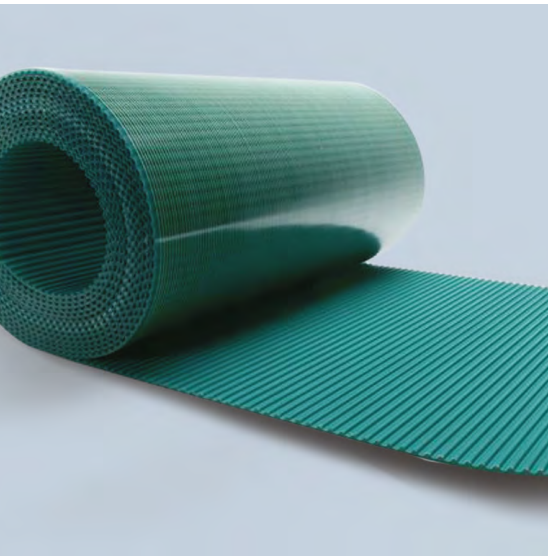

MEGALINEAR

H WIDE OPEN-ENDED

STANDARD WIDTHS (inch)	800	1000	1200	1600	2000
STANDARD WIDTHS (mm)	203,2	254	304,8	406,4	508
Weight (gr/m)	410	510	615	820	1020

Standard compound	transparent polyurethane thermoplastic 92 ShA
Standard back cover	none
Standard tooth cover	none
Standard cords	S and Z torsion kevlar at pitch 3,2 mm
Standard width tolerance	+/- 2 mm
Standard thickness	4,3 +/- 0,3 mm
Standard length tolerance	+/- 0,8 mm/m
Standard roll length	100 m
Belt options on request with minimum quantity	Nylon fabric back Nylon fabric teeth Antistatic nylon fabric Transparent FDA compound

TOOTH PROFILE ACCORDING TO ISO 5296-1

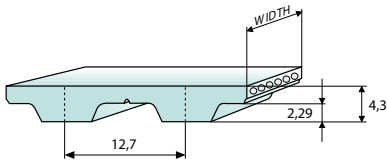

TOOTH RESISTANCE

RPM (1/min)	0	20	40	60	80	100	200	300	400	500	750	1000
F _{p spec} (N/cm)	31	30	29	29	28	27	25	24	23	21	20	19

TRACTION RESISTANCE

CORD MATERIAL	BELT WIDTH (INCH)	800	1000	1200	1600	2000
		Max Traction Load (N)	8530	10475	12570	16910
Kevlar	Breaking Strength (N)	29855	36665	43995	59185	73330
	Elongation at MTL (mm/m)	8	8	8	8	8

Average values



MEGALINEAR

H WIDE OPEN-ENDED

FLEXION RESISTANCE

	Z _{MIN}	IDLER MIN DIA (MM)	Z _{MIN}	IDLER MIN DIA (MM)
Kevlar cords	20	80	14	60

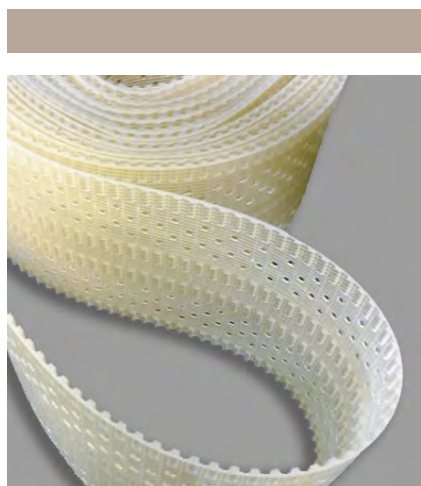

JOINED BELT INFORMATION:

- Traction and tooth resistances = 50% less than open-ended
- Joined belt can be used only in conveyor systems
- Rolls with NFT and NFB can be joined too
- Minimum diameters according above table

PULLEYS

(FOR MORE DETAILS PLEASE SEE OUR PULLEYS CATALOGUE)

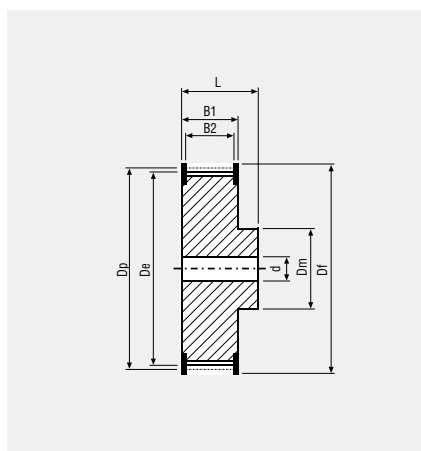

N° TEETH	DP	DE	N° TEETH	DP	DE
14	56,60	55,23	28	113,19	111,82
15	60,64	59,27	29	117,23	115,86
16	64,68	63,31	30	121,28	119,91
17	68,72	67,35	32	129,36	127,99
18	72,77	71,40	33	133,40	132,03
19	76,81	75,44	34	137,45	136,08
20	80,85	79,48	35	141,49	140,12
21	84,89	83,52	36	145,53	144,16
22	88,94	87,57	38	153,62	152,25
23	92,98	91,61	40	161,70	160,33
24	97,02	95,65	44	177,87	176,50
25	101,06	99,69	48	194,04	192,67
26	105,11	103,74	52	210,21	208,84
27	109,15	107,78	60	242,55	241,18

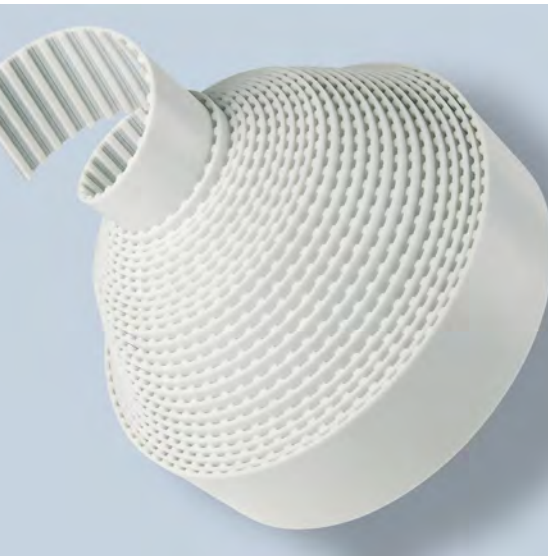

MEGALINEAR

XH OPEN-ENDED

STANDARD WIDTHS (inch)	100	150	200	300	400	600
STANDARD WIDTHS (mm)	25,4	38,1	50,8	76,2	101,6	152,4
Weight (gr/m)	250	400	530	795	1060	1625

Standard compound	white polyurethane thermoplastic 92 ShA
Standard back cover	none
Standard tooth cover	none
Standard cords	S and Z torsion zinked steel
Standard width tolerance	+/- 1 mm
Standard thickness	11,2 +/- 0,5 mm
Standard length tolerance	+/- 0,8 mm/m
Standard roll length	100 m

TOOTH PROFILE ACCORDING TO ISO 5296-1

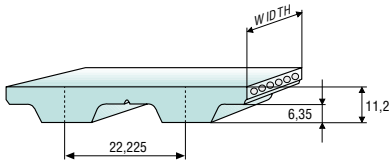

Belt options on request with minimum quantity

- Nylon fabric back**
- Nylon fabric teeth**
- Antistatic nylon fabric**
- Transparent FDA compound**
- AVAFC 60/70/85 ShA**
- APL**
- Fishbone**
- Ribbed**
- Cleats**

Different back coating materials see page 134

TOOTH RESISTANCE

RPM (1/min)	0	20	40	60	80	100	200	300	400	500	750	1000	1500	2000	3000	4000
F _{p spec} (N/cm)	115	111	108	105	103	101	92	86	81	78	70	65	57	51	43	37

Minimum suggested number of teeth in clamp for linear movement: 7

TRACTION RESISTANCE

CORD MATERIAL	BELT WIDTH (INCH)	100	150	200	300	400	600
Steel	Max Traction Load (N)	3800	5935	8075	13000	19000	28225
	Breaking Strength (N)	15200	23750	32300	49400	66500	98800
	Elongation at MTL (mm/m)	4	4	4	4	4	4
Kevlar	Max Traction Load (N)	5045	7990	11515	17715	25965	39425
	Breaking Strength (N)	20195	31975	43755	67315	90875	138000
	Elongation at MTL (mm/m)	8	8	8	8	8	8
Stainless	Max Traction Load (N)	3175	4960	6745	-	-	-
	Breaking Strength (N)	12700	19850	26995	-	-	-
	Elongation at MTL (mm/m)	3,8	3,8	3,8	-	-	-

Average values



MEGALINEAR

XH OPEN-ENDED

FLEXION RESISTANCE

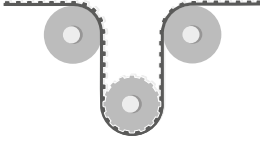
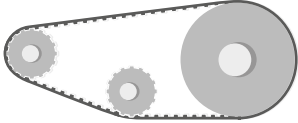
			
	Z_{MIN}	Z_{MIN} IDLER MIN DIA (MM)	Z_{MIN} IDLER MIN DIA (MM)
Standard steel cords	18	20 180	18 150
Kevlar cords	18	20 180	18 150
Stainless steel cords	23	25 180	23 165

JOINED BELT INFORMATION:

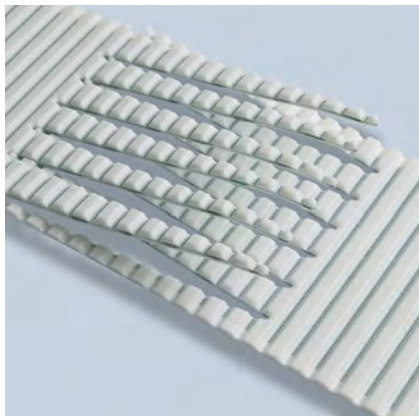

- Minimum splice length 900 mm
- Traction and tooth resistances = 50% less than open-ended
- Joined belt can be used only in conveyor systems
- Rolls with NFT, NFB, AVAFC and APL can be joined too
- Minimum diameters according above table
- For coated belts, minimum diameters on page 134

PULLEYS

(FOR MORE DETAILS PLEASE SEE OUR PULLEYS CATALOGUE)

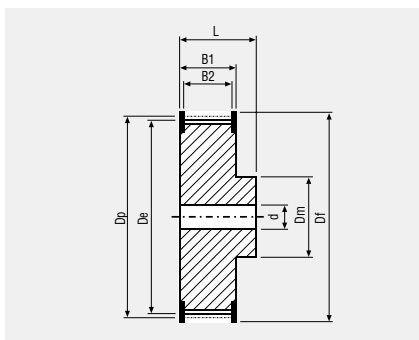

N° TEETH	DP	DE	N° TEETH	DP	DE
18	127,34	124,55	40	282,98	280,19
20	141,49	138,70	44	311,28	308,48
22	155,64	152,83	48	339,57	336,78
24	169,79	167,00	60	424,47	421,68
26	183,92	181,13	72	509,36	506,57
28	198,08	195,29	84	594,25	591,46
30	212,23	209,44	96	679,15	676,35
32	226,38	223,59	120	848,93	846,14

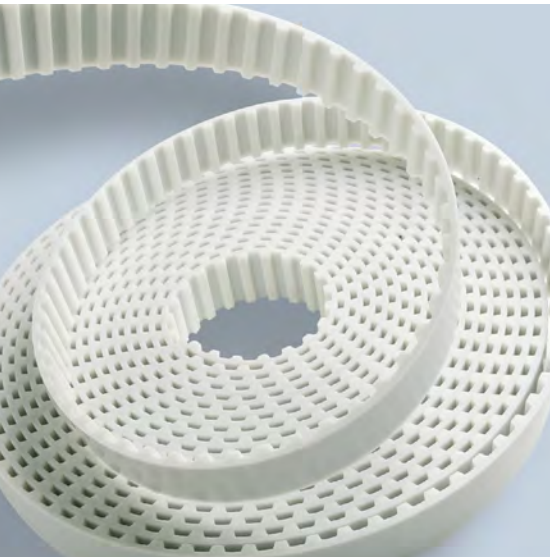

MEGALINEAR

T2,5 OPEN-ENDED

STANDARD WIDTHS (mm)	10	16	20
Weight (gr/m)	14	23	28

Standard compound	white polyurethane thermoplastic 92 ShA
Standard back cover	none
Standard tooth cover	none
Standard cords	one torsion zinked steel
Standard width tolerance	+/- 0,3 mm
Standard thickness	1,3 +/- 0,15 mm
Standard length tolerance	+/- 0,8 mm/m
Standard roll length	100 m

TOOTH PROFILE ACCORDING TO ISO 17396

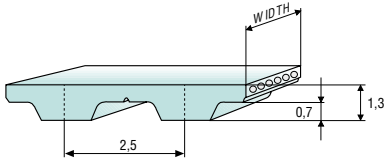

TOOTH RESISTANCE

RPM (1/min)	0	20	40	60	80	100	200	300	400	500	750	1000	1500	2000	3000	4000
F _{p spec} (N/cm)	9	8,7	8,4	8,2	8,1	7,9	7,3	7	6,7	6,4	6	5,7	5,2	4,9	4,4	4

Minimum suggested number of teeth in clamp for linear movement: 7

TRACTION RESISTANCE

CORD MATERIAL	BELT WIDTH (MM)	10	16	20
Steel	Max Traction Load (N)	105	170	215
	Breaking Strength (N)	435	695	870
	Elongation at MTL (mm/m)	4	4	4

Average values



MEGALINEAR

T2,5 OPEN-ENDED

FLEXION RESISTANCE

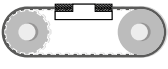
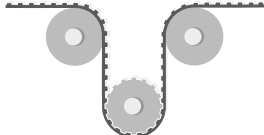
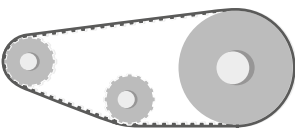
			
	Z_{MIN}	Z_{MIN} IDLER MIN DIA (MM)	Z_{MIN} IDLER MIN DIA (MM)
Standard steel cord	10	18 15	10 18

JOINED BELT INFORMATION:

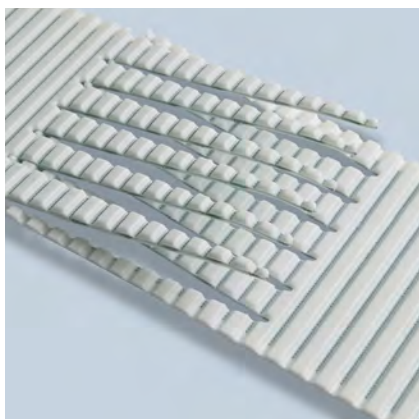

- Minimum splice length 500 mm
- Traction and tooth resistances = 50% less than open-ended
- Joined belt can be used only in conveyor systems
- Minimum diameters according above table

PULLEYS

(FOR MORE DETAILS PLEASE SEE OUR PULLEYS CATALOGUE)

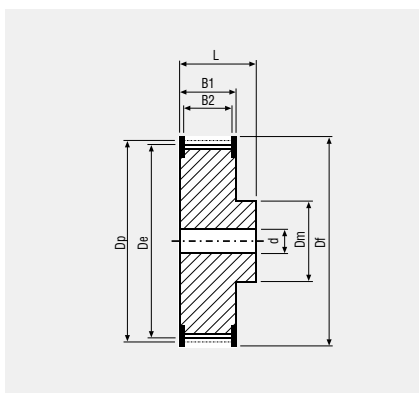

N° TEETH	DP	DE
10	7,96	7,45
11	8,75	8,25
12	9,55	9,00
13	10,34	9,80
14	11,14	10,60
15	11,94	11,40
16	12,73	12,20
17	13,53	13,00
18	14,32	13,80
19	15,12	14,60
20	15,92	15,40
21	16,71	16,20

N° TEETH	DP	DE
22	17,51	17,00
24	19,10	18,55
26	20,69	20,15
28	22,28	21,75
30	23,87	23,35
32	25,46	24,95
36	28,65	28,10
40	31,83	31,30
44	35,01	34,50
48	38,20	37,70
60	47,75	47,25
72	55,20	55,20

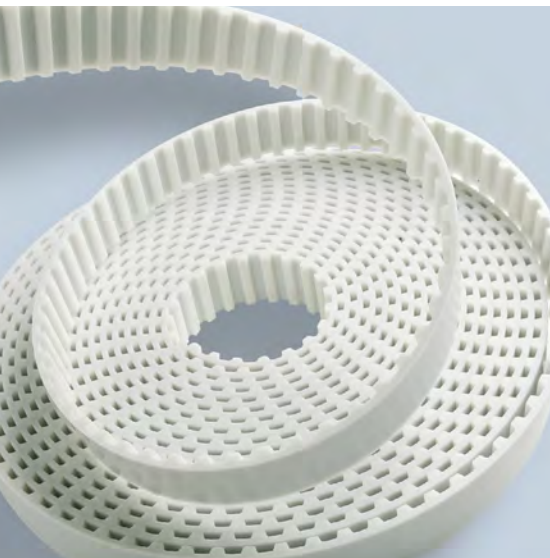

MEGALINEAR

T5 OPEN-ENDED

STANDARD WIDTHS (mm)	6	10	16	25	32	50	75	100	150
Weight (gr/m)	15	20	35	55	70	105	160	215	330

Standard compound	white polyurethane thermoplastic 92 ShA
Standard back cover	none
Standard tooth cover	none
Standard cords	S and Z torsion zinked steel
Standard width tolerance	+/- 0,5 mm
Standard thickness	2,2 +/- 0,15 mm
Standard thickness with NFT-NFB	2,4 +/- 0,15 mm*
Standard length tolerance	+/- 0,8 mm/m
Standard roll length	100 m

TOOTH PROFILE ACCORDING TO ISO 17396

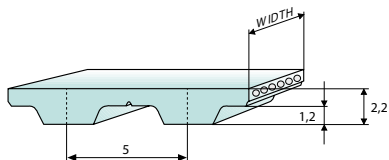

Belt options on request with minimum quantity

Nylon fabric back
Nylon fabric teeth
Antistatic nylon fabric
Transparent FDA compound
AVAFC 60/70/85 ShA
APL
Fishbone
Ribbed
Cleats

Different back coating materials see page 134

TOOTH RESISTANCE

RPM (1/min)	0	20	40	60	80	100	200	300	400	500	750	1000	1500	2000	3000	4000	5000	8000
F _{p spec} (N/cm)	24	23	23	22	22	22	20	19	19	18	17	16	15	14	12	11	11	9

Minimum suggested number of teeth in clamp for linear movement: 7

TRACTION RESISTANCE

CORD MATERIAL	BELT WIDTH (MM)	6	10	16	25	32	50	75	100	150
Steel	Max Traction Load (N)	185	375	500	840	1060	1750	2400	3220	3640
	Breaking Strength (N)	750	1500	2000	3375	4250	7000	9125	12250	12750
	Elongation at MTL (mm/m)	4	4	4	4	4	4	4	4	4
Kevlar	Max Traction Load (N)	490	985	1315	2225	2800	4615	6335	8505	9610
	Breaking Strength (N)	1975	3955	5275	8900	11210	18465	24075	32320	33635
	Elongation at MTL (mm/m)	8	8	8	8	8	8	8	8	8
HP	Max Traction Load (N)	-	585	780	1315	1655	2730	3745	5025	-
	Breaking Strength (N)	-	2340	3120	5265	6630	10920	14235	19110	-
	Elongation at MTL (mm/m)	-	4	4	4	4	4	4	4	-
HF	Max Traction Load (N)	-	490	655	1105	1390	2295	3150	4225	-
	Breaking Strength (N)	-	1965	2620	4425	5575	9180	11970	16070	-
	Elongation at MTL (mm/m)	-	5	5	5	5	5	5	5	-
Stainless	Max Traction Load (N)	155	305	410	695	-	-	-	-	-
	Breaking Strength (N)	615	1235	1645	2780	-	-	-	-	-
	Elongation at MTL (mm/m)	3,8	3,8	3,8	3,8	-	-	-	-	-

Average values

MEGALINEAR



MEGALINEAR

T5 OPEN-ENDED

FLEXION RESISTANCE

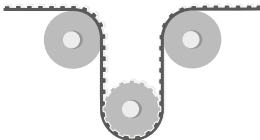
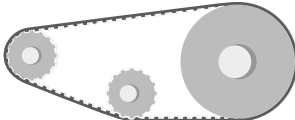
			
	Z_{MIN}	Z_{MIN} IDLER MIN DIA (MM)	Z_{MIN} IDLER MIN DIA (MM)
Standard steel cords	10	15 30	10 30
Kevlar cords	12	15 30	12 30
High Power cords	15	15 40	15 60
High Flexibility cords	10	12 30	10 30
Stainless steel cords	15	18 40	15 40

JOINED BELT INFORMATION:



- Minimum splice length 900 mm
- Traction and tooth resistances = 50% less than open-ended
- Joined belt can be used only in conveyor systems
- Rolls with NFT, NFB, AVAFC and APL can be joined too
- Minimum diameters according above table
- For coated belts, minimum diameters on page 134

PULLEYS

(FOR MORE DETAILS PLEASE SEE OUR PULLEYS CATALOGUE)

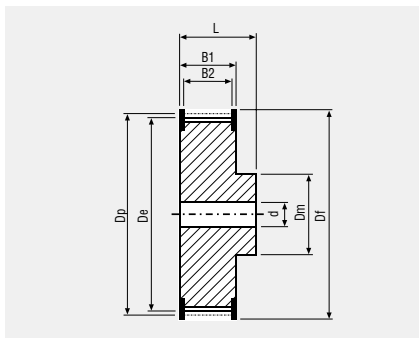

N° TEETH	DP	DE
10	15,92	15,09
12	19,10	18,27
14	22,28	21,45
15	23,87	23,04
16	25,46	24,64
18	28,65	27,82
19	30,24	29,41
20	31,83	31,00
22	35,01	34,19
24	38,20	37,37

N° TEETH	DP	DE
25	39,79	38,96
28	44,56	43,73
30	47,75	46,92
32	50,93	50,10
36	57,30	56,47
40	63,66	62,93
42	66,85	66,02
44	70,03	69,20
48	76,39	75,57
60	95,49	94,67

MEGALINEAR

MEGAECO BIOBASED T5

STANDARD WIDTHS (mm)	6	10	16	25	32	50	75	100	150
Weight (gr/m)	15	20	35	55	70	105	160	215	330

Standard compound	green polyurethane thermoplastic 90 ShA
Standard back cover	none
Standard tooth cover	none
Standard cords	S and Z torsion zinked steel
Standard width tolerance	+/- 0,5 mm
Standard thickness	2,2 +/- 0,15 mm
Standard length tolerance	+/- 0,8 mm/m
Standard roll length	100 m

MEGALINEAR MegaEco Biobased is the eco-friendly and impact-reducing belt solutions with no compromise on the quality of performance.



TOOTH PROFILE ACCORDING TO ISO 17396

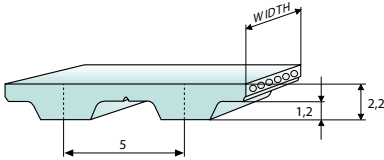

TOOTH RESISTANCE

RPM (1/min)	0	20	40	60	80	100	200	300	400	500	750	1000	1500	2000	3000	4000	5000	8000
F _{p spec} (N/cm)	24	23	23	22	22	22	20	19	19	18	17	16	15	14	12	11	11	9

Minimum suggested number of teeth in clamp for linear movement: 7

TRACTION RESISTANCE

CORD MATERIAL	BELT WIDTH (MM)	6	10	16	25	32	50	75	100	150
Steel	Max Traction Load (N)	185	375	500	840	1060	1750	2400	3220	3640
	Breaking Strength (N)	750	1500	2000	3375	4250	7000	9125	12250	12750
	Elongation at MTL (mm/m)	4	4	4	4	4	4	4	4	4

Average values

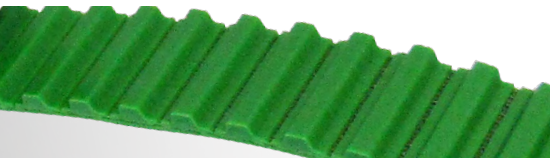

MEGALINEAR

MEGAECO BIOBASED T5

FLEXION RESISTANCE

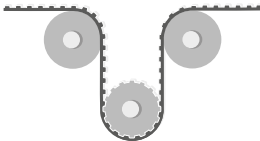
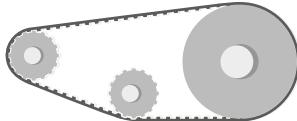
			
	Z_{MIN}	Z_{MIN}	Z_{MIN}
		IDLER MIN DIA (MM)	IDLER MIN DIA (MM)
Standard steel cords	10	15	10
		30	30

JOINED BELT INFORMATION:

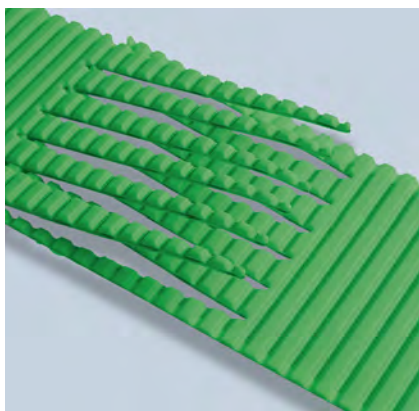

- Minimum splice length 900 mm
- Traction and tooth resistances = 50% less than open-ended
- Joined belt can be used only in conveyor systems
- Minimum diameters according above table

PULLEYS

(FOR MORE DETAILS PLEASE SEE OUR PULLEYS CATALOGUE)

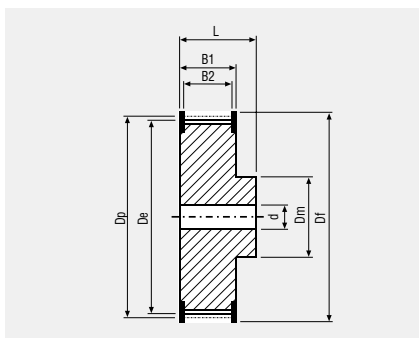

N° TEETH	DP	DE
10	15,92	15,09
12	19,10	18,27
14	22,28	21,45
15	23,87	23,04
16	25,46	24,64
18	28,65	27,82
19	30,24	29,41
20	31,83	31,00
22	35,01	34,19
24	38,20	37,37

N° TEETH	DP	DE
25	39,79	38,96
28	44,56	43,73
30	47,75	46,92
32	50,93	50,10
36	57,30	56,47
40	63,66	62,93
42	66,85	66,02
44	70,03	69,20
48	76,39	75,57
60	95,49	94,67

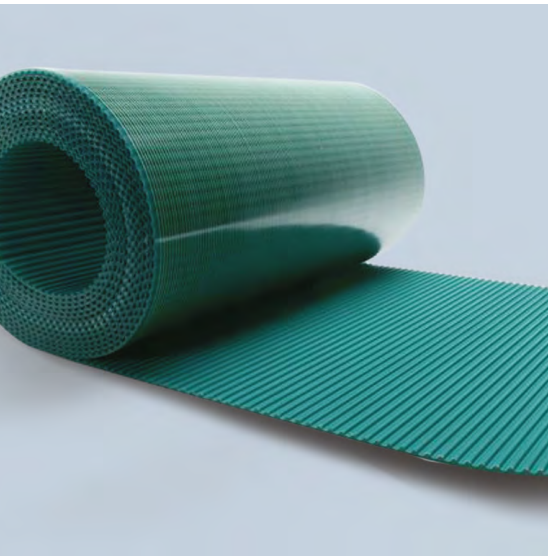

MEGALINEAR

T5 WIDE OPEN-ENDED

STANDARD WIDTHS (mm)	250	500
Weight (gr/m)	500	1000

Standard compound	transparent polyurethane thermoplastic 90 ShA
Standard back cover	none
Standard tooth cover	none
Standard cords	S and Z torsion Kevlar at pitch 3,5 mm
Standard width tolerance	+/- 2 mm
Standard thickness	2,2 +/- 0,15 mm
Standard length tolerance	+/- 0,8 mm/m
Standard roll length	100 m
Belt options on request with minimum quantity	Nylon fabric back Nylon fabric teeth Transparent FDA compound

TOOTH PROFILE ACCORDING TO ISO 17396

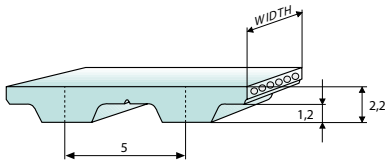

TOOTH RESISTANCE

RPM (1/min)	0	20	40	60	80	100	200	300	400	500	750	1000
F _{p spec} (N/cm)	17	16	16	15	15	15	14	13	13	12	12	11

Minimum suggested number of teeth in clamp for linear movement: 7

TRACTION RESISTANCE

CORD MATERIAL	BELT WIDTH (MM)	250	500
		Max Traction Load (N)	6595
Kevlar	Breaking Strength (N)	23085	46170
	Elongation at MTL (mm/m)	8	8

Average values



MEGALINEAR

T5 WIDE OPEN-ENDED

FLEXION RESISTANCE

	Z _{MIN}	IDLER MIN DIA (MM)	Z _{MIN}	IDLER MIN DIA (MM)
Kevlar cords	15	45	12	45

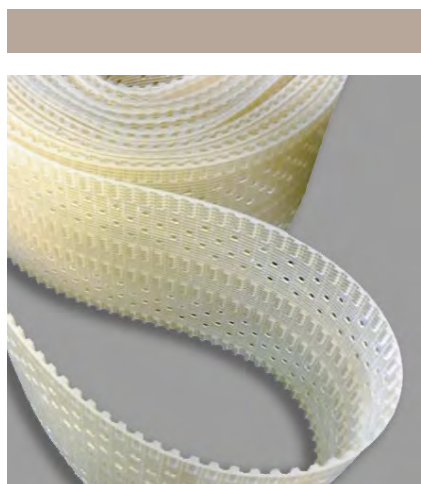

JOINED BELT INFORMATION:

- Traction and tooth resistances = 50% less than open-ended
- Joined belt can be used only in conveyor systems
- Rolls with NFT and NFB can be joined too
- Minimum diameters according above table

PULLEYS

(FOR MORE DETAILS PLEASE SEE OUR PULLEYS CATALOGUE)

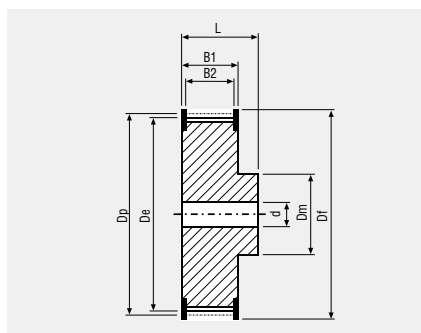

N° TEETH	DP	DE
10	15,92	15,09
12	19,10	18,275
14	22,28	21,45
15	23,87	23,04
16	25,46	24,64
18	28,65	27,82
19	30,24	29,41
20	31,83	31,00
22	35,01	34,19
24	38,20	37,37

N° TEETH	DP	DE
25	39,79	38,96
28	44,56	43,73
30	47,75	46,92
32	50,93	50,10
36	57,30	56,47
40	63,66	62,93
42	66,85	66,02
44	70,03	69,20
48	76,39	75,57
60	95,49	94,67

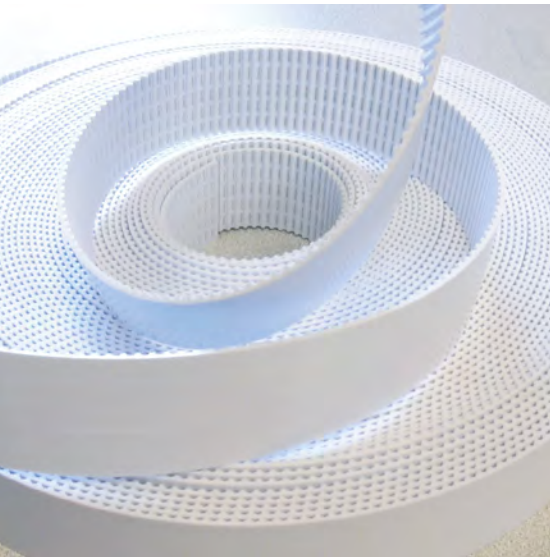

MEGALINEAR

TT5 FOR KNITTING MACHINE

STANDARD WIDTHS (mm)	10
Weight (gr/m)	20

Standard compound	white polyurethane thermoplastic 88 ShA
Standard back cover	none
Standard tooth cover	none
Standard cords	S and Z torsion zinked steel
Standard width tolerance	+/- 0,5 mm
Standard thickness	3 + 0,2/- 0,1 mm
Standard length tolerance	+/- 0,8 mm/m
Standard roll length	100 m

TOOTH PROFILE ACCORDING TO ISO 17396

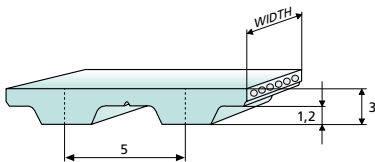

TOOTH RESISTANCE

RPM (1/min)	0	20	40	60	80	100	200	300	400	500	750	1000	1500	2000	3000	4000	5000	8000
F _{p spec} (N/cm)	24	23	23	22	22	22	20	19	19	18	17	16	15	14	12	11	11	9

Minimum suggested number of teeth in clamp for linear movement: 7

TRACTION RESISTANCE

CORD MATERIAL	BELT WIDTH (MM)	10
Steel	Max Traction Load (N)	375
	Breaking Strength (N)	1500
	Elongation at MTL (mm/m)	4
Kevlar	Max Traction Load (N)	795
	Breaking Strength (N)	3190
	Elongation at MTL (mm/m)	8

Average values



MEGALINEAR

TT5 FOR KNITTING MACHINE

FLEXION RESISTANCE

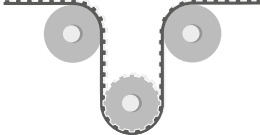
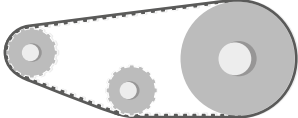
			
	Z_{MIN}	Z_{MIN} IDLER MIN DIA (MM)	Z_{MIN} IDLER MIN DIA (MM)
Standard steel cords	10	15 30	10 30
Kevlar cords	12	15 30	12 30

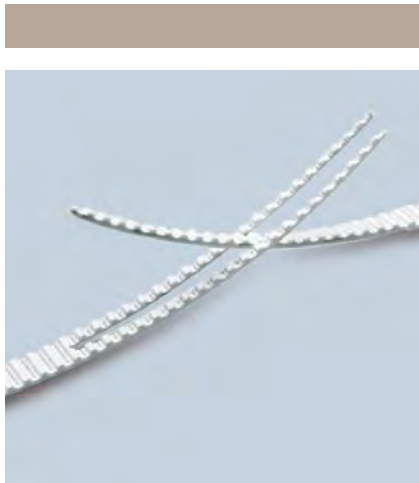

JOINED BELT INFORMATION:

- Minimum splice length 500 mm
- Traction and tooth resistances = 50% less than open-ended
- Joined belt can be used only in conveyor systems
- Minimum diameters according above table



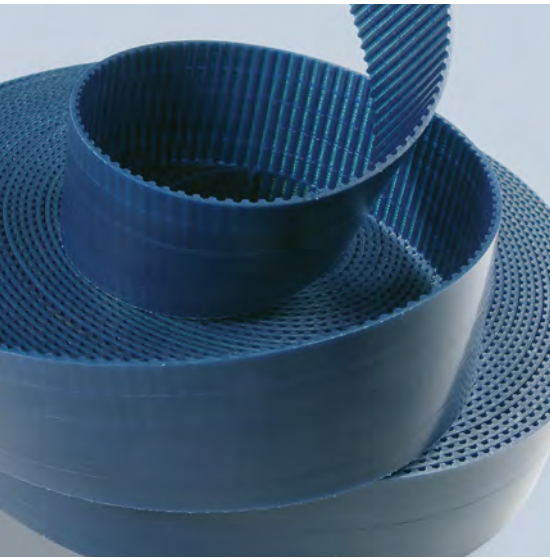

MEGALINEAR

TT5 FOR KNITTING MACHINE

STANDARD WIDTHS (mm)	10
Weight (gr/m)	20

Standard compound	blue polyurethane thermoplastic 88 ShA
Standard back cover	none
Standard tooth cover	none
Standard cords	S and Z torsion kevlar
Standard width tolerance	+/- 0,5 mm
Standard thickness	2,8 +/- 0,15 mm
Standard length tolerance	+/- 0,8 mm/m
Standard roll length	100 m

TOOTH PROFILE ACCORDING TO ISO 17396

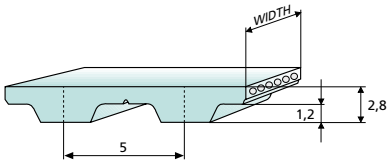

TOOTH RESISTANCE

RPM (1/min)	0	20	40	60	80	100	200	300	400	500	750	1000	1500	2000	3000	4000	5000	8000
F _{p spec} (N/cm)	24	23	23	22	22	22	20	19	19	18	17	16	15	14	12	11	11	9

Minimum suggested number of teeth in clamp for linear movement: 7

TRACTION RESISTANCE

CORD MATERIAL	BELT WIDTH (MM)	10
Steel	Max Traction Load (N)	375
	Breaking Strength (N)	1500
	Elongation at MTL (mm/m)	4
Kevlar	Max Traction Load (N)	795
	Breaking Strength (N)	3190
	Elongation at MTL (mm/m)	8

Average values



MEGALINEAR

TT5 FOR KNITTING MACHINE

FLEXION RESISTANCE

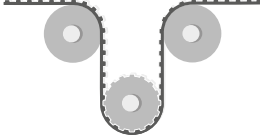
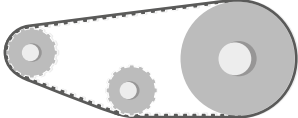
			
	Z_{MIN}	Z_{MIN} IDLER MIN DIA (MM)	Z_{MIN} IDLER MIN DIA (MM)
Standard steel cords	10	15 30	10 30
Kevlar cords	12	15 30	12 30

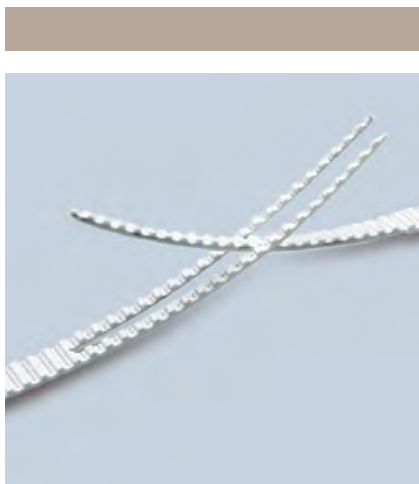

JOINED BELT INFORMATION:

- Minimum splice length 500 mm
- Traction and tooth resistances = 50% less than open-ended
- Joined belt can be used only in conveyor systems
- Minimum diameters according above table



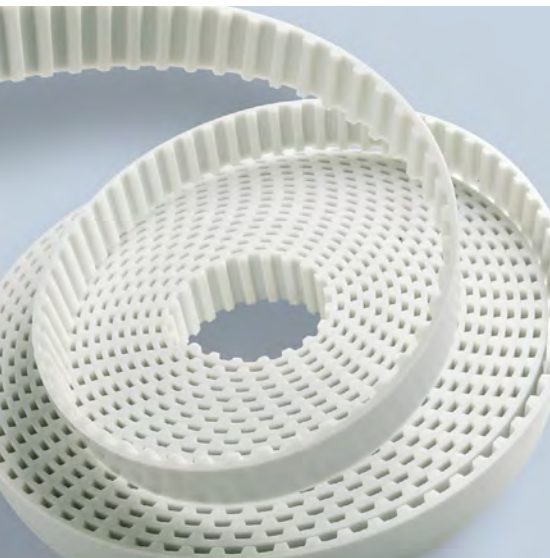

MEGALINEAR

T10 OPEN-ENDED

STANDARD WIDTHS (mm)	12	16	25	32	50	75	100	150
Weight (gr/m)	50	75	115	145	225	340	435	680

Standard compound	white polyurethane thermoplastic 92 ShA
Standard back cover	none
Standard tooth cover	none
Standard cords	S and Z torsion zinked steel
Standard width tolerance	+/- 0,5 mm
Standard thickness	4,5 +/- 0,3 mm
Standard length tolerance	+/- 0,8 mm/m
Standard roll length	100 m

TOOTH PROFILE ACCORDING TO ISO 17396

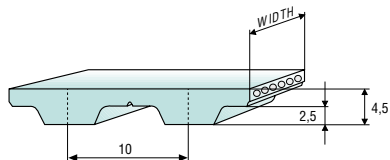

Belt options on request with minimum quantity

- Nylon fabric back**
- Nylon fabric teeth**
- Antistatic nylon fabric**
- Transparent FDA compound**
- AVAFC 60/70/85 ShA**
- APL**
- Fishbone**
- Ribbed**
- SUPERGRIP PVC**
- Cleats**

Different back coating materials see page 134

TOOTH RESISTANCE

RPM (1/min)	0	20	40	60	80	100	200	300	400	500	750	1000	1500	2000	3000	4000	5000	8000
F _{p spec} (N/cm)	51	49	48	47	46	45	41	39	37	36	33	31	28	25	22	20	18	14

Minimum suggested number of teeth in clamp for linear movement: 7

TRACTION RESISTANCE

CORD MATERIAL	BELT WIDTH (MM)	12	16	25	32	50	75	100	150
Steel	Max Traction Load (N)	1050	1470	2410	3045	5040	8065	10830	12480
	Breaking Strength (N)	4200	5880	9660	12180	20160	30660	41160	43680
	Elongation at MTL (mm/m)	4	4	4	4	4	4	4	4
Kevlar	Max Traction Load (N)	915	1175	2095	2615	4450	7165	9645	15560
	Breaking Strength (N)	3665	4710	8380	10475	17805	27235	36665	54475
	Elongation at MTL (mm/m)	8	8	8	8	8	8	8	8
HP	Max Traction Load (N)	1660	2135	3800	4750	8075	13000	17500	28225
	Breaking Strength (N)	6650	8550	15200	19000	32300	49400	66500	98800
	Elongation at MTL (mm/m)	4	4	4	4	4	4	4	4
HF	Max Traction Load (N)	1100	1540	2530	3190	5280	8450	11345	13070
	Breaking Strength (N)	4400	6160	10120	12760	21120	32120	43120	45760
	Elongation at MTL (mm/m)	5	5	5	5	5	5	5	5
HPF	Max Traction Load (N)	-	2385	4240	5300	9010	14505	19525	31495
	Breaking Strength (N)	-	9540	16960	21200	36040	55120	74200	110240
	Elongation at MTL (mm/m)	5	5	5	5	5	5	5	5
Stainless	Max Traction Load (N)	950	1330	2190	2760	4570	-	-	-
	Breaking Strength (N)	3810	5330	8760	11045	18285	-	-	-
	Elongation at MTL (mm/m)	3,8	3,8	3,8	3,8	3,8	-	-	-

Average values

MEGALINEAR



MEGALINEAR

T10 OPEN-ENDED

FLEXION RESISTANCE

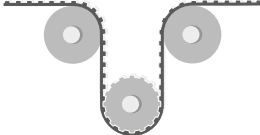
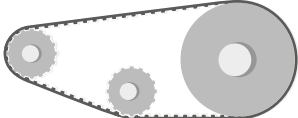
			
	Z_{MIN}	Z_{MIN} IDLER MIN DIA (MM)	Z_{MIN} IDLER MIN DIA (MM)
Standard steel cords	12	20 60	12 60
Kevlar cords	15	20 60	15 60
High Power cords	15	20 100	15 100
High Flexibility cords	12	15 50	12 50
High Power Flexible cords	14	20 80	14 80
Stainless steel cords	15	20 70	15 70

JOINED BELT INFORMATION:

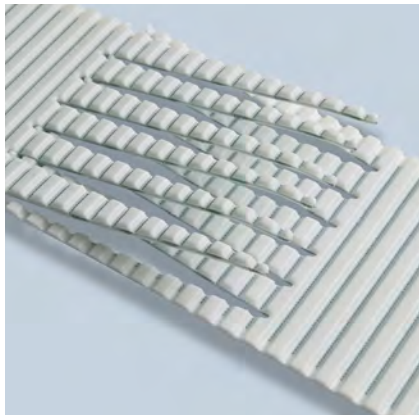

- Minimum splice length 900 mm
- Traction and tooth resistances = 50% less than open-ended
- Joined belt can be used only in conveyor systems
- Rolls with NFT, NFB, AVAFC and APL can be joined too
- Minimum diameters according above table
- For coated belts, minimum diameters on page 134

PULLEYS

(FOR MORE DETAILS PLEASE SEE OUR PULLEYS CATALOGUE)

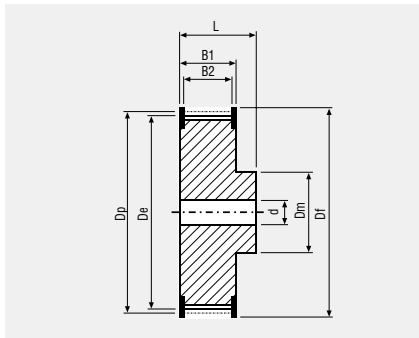

N° TEETH	DP	DE
12	38,20	36,35
14	44,56	42,71
15	47,75	45,90
16	50,93	49,08
18	57,30	55,45
19	60,48	58,63
20	63,66	61,81
22	70,03	68,18
24	76,39	74,55
25	79,58	77,73

N° TEETH	DP	DE
26	82,76	80,91
27	85,94	84,10
28	89,13	87,28
30	95,49	93,65
32	101,86	100,01
36	114,59	112,74
40	127,32	125,48
44	140,06	138,21
48	152,79	150,94
60	190,99	189,14

MEGALINEAR

MEGAECO BIOBASED T10

STANDARD WIDTHS (mm)	12	16	25	32	50	75	100	150
Weight (gr/m)	50	75	115	145	225	340	435	680

Standard compound	green polyurethane thermoplastic 90 ShA
Standard back cover	none
Standard tooth cover	none
Standard cords	S and Z torsion zinked steel
Standard width tolerance	+/- 0,5 mm
Standard thickness	4,5 +/- 0,3 mm
Standard length tolerance	+/- 0,8 mm/m
Standard roll length	100 m

MEGALINEAR MegaEco Biobased is the eco-friendly and impact-reducing belt solutions with no compromise on the quality of performance.



TOOTH PROFILE ACCORDING TO ISO 17396

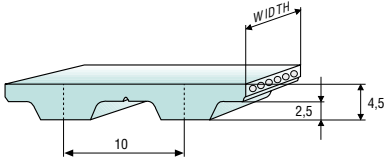

TOOTH RESISTANCE

RPM (1/min)	0	20	40	60	80	100	200	300	400	500	750	1000	1500	2000	3000	4000	5000	8000
F _{p spec} (N/cm)	51	49	48	47	46	45	41	39	37	36	33	31	28	25	22	20	18	14

Minimum suggested number of teeth in clamp for linear movement: 7

TRACTION RESISTANCE

CORD MATERIAL	BELT WIDTH (MM)	12	16	25	32	50	75	100	150
Steel	Max Traction Load (N)	1050	1470	2410	3045	5040	8065	10830	12480
	Breaking Strength (N)	4200	5880	9660	12180	20160	30660	41160	43680
	Elongation at MTL (mm/m)	4	4	4	4	4	4	4	4

Average values

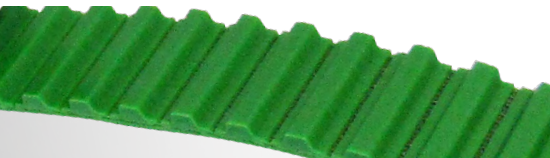

MEGALINEAR

MEGAECO BIOBASED T10

FLEXION RESISTANCE

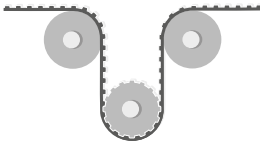
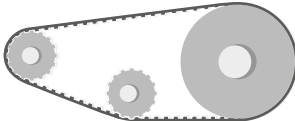
			
	Z_{MIN}	Z_{MIN} IDLER MIN DIA (MM)	Z_{MIN} IDLER MIN DIA (MM)
Standard steel cords	12	20 60	12 60

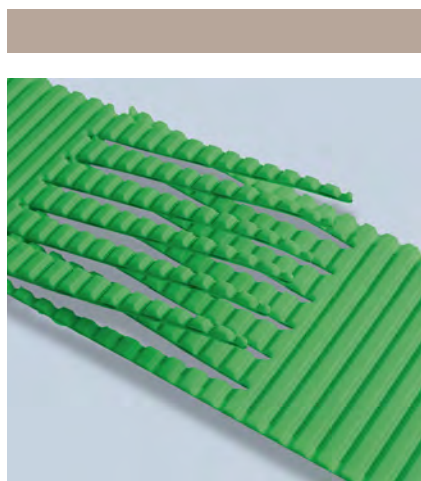

JOINED BELT INFORMATION:

- Minimum splice length 900 mm
- Traction and tooth resistances = 50% less than open-ended
- Joined belt can be used only in conveyor systems
- Minimum diameters according to the table above

PULLEYS

(FOR MORE DETAILS PLEASE SEE OUR PULLEYS CATALOGUE)

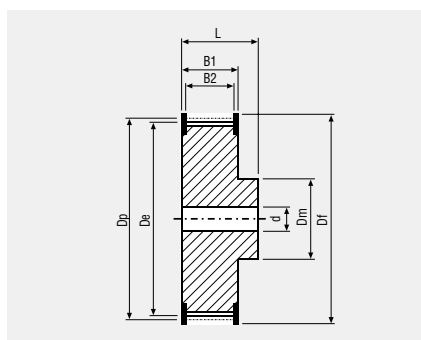

N° TEETH	DP	DE	N° TEETH	DP	DE
12	38,20	36,35	26	82,76	80,91
14	44,56	42,71	27	85,94	84,10
15	47,75	45,90	28	89,13	87,28
16	50,93	49,08	30	95,49	93,65
18	57,30	55,45	32	101,86	100,01
19	60,48	58,63	36	114,59	112,74
20	63,66	61,81	40	127,32	125,48
22	70,03	68,18	44	140,06	138,21
24	76,39	74,55	48	152,79	150,94
25	79,58	77,73	60	190,99	189,14

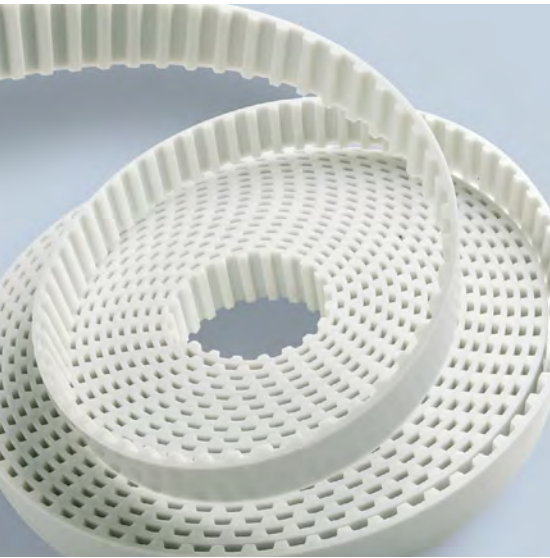

MEGALINEAR

T10 WITHOUT GAP OPEN-ENDED

STANDARD WIDTHS (mm)	16	25	32	50	75
Weight (gr/m)	74	115	148	230	345

Standard compound	white polyurethane thermoplastic 92 ShA
Standard back cover	none
Standard tooth cover	none
Standard cords	S and Z torsion zinked steel
Standard width tolerance	+/- 0,5 mm
Standard thickness	4,5 +/- 0,3 mm
Standard length tolerance	+/- 0,8 mm/m
Standard roll length	100 m

TOOTH PROFILE ACCORDING TO ISO 17396

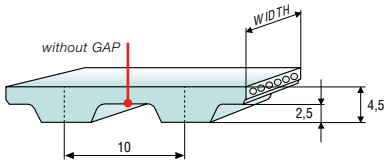

TOOTH RESISTANCE

RPM (1/min)	0	20	40	60	80	100	200	300	400	500	750	1000	1500	2000	3000	4000	5000	8000
F _{p spec} (N/cm)	51	49	48	47	46	45	41	39	37	36	33	31	28	25	22	20	18	14

Minimum suggested number of teeth in clamp for linear movement: 7

TRACTION RESISTANCE

CORD MATERIAL	BELT WIDTH (MM)	16	25	32	50	75
Steel	Max Traction Load (N)	1365	2310	2940	4830	7955
	Breaking Strength (N)	5460	9240	11760	19320	30240
	Elongation at MTL (mm/m)	4	4	4	4	4
Kevlar	Max Traction Load (N)	1700	2880	3665	6020	9920
	Breaking Strength (N)	6805	11520	14665	24090	37710
	Elongation at MTL (mm/m)	8	8	8	8	8

Average values



MEGALINEAR

T10 WITHOUT GAP OPEN-ENDED

FLEXION RESISTANCE

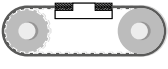
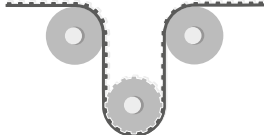
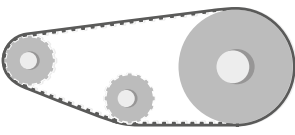
			
	Z_{MIN}	Z_{MIN} IDLER MIN DIA (MM)	Z_{MIN} IDLER MIN DIA (MM)
Standard steel cords	12	20 60	12 60
Kevlar cords	15	20 60	15 60

PULLEYS

(FOR MORE DETAILS PLEASE SEE OUR PULLEYS CATALOGUE)

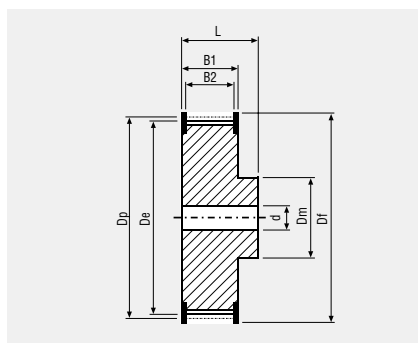

N° TEETH	DP	DE
12	38,20	36,35
14	44,56	42,71
15	47,75	45,90
16	50,93	49,08
18	57,30	55,45
19	60,48	58,63
20	63,66	61,81
22	70,03	68,18
24	76,39	74,55
25	79,58	77,73

N° TEETH	DP	DE
26	82,76	80,91
27	85,94	84,10
28	89,13	87,28
30	95,49	93,65
32	101,86	100,01
36	114,59	112,74
40	127,32	125,48
44	140,06	138,21
48	152,79	150,94
60	190,99	189,14

TYPICAL APPLICATION: CAR WASHING MACHINE



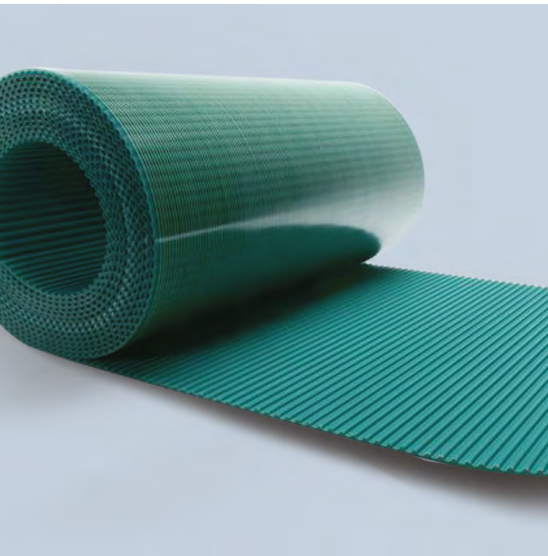

MEGALINEAR

T10 WIDE OPEN-ENDED

STANDARD WIDTHS (mm)	200	250	300	400	450	500
Weight (gr/m)	410	510	615	820	920	1020

Standard compound	transparent polyurethane thermoplastic 90 ShA
Standard back cover	none
Standard tooth cover	none
Standard cords	S and Z torsion Kevlar at pitch 3,5 mm
Standard width tolerance	+/- 2 mm
Standard thickness	4,5 +/- 0,3 mm
Standard length tolerance	+/- 0,8 mm/m
Standard roll length	100 m
Belt options on request with minimum quantity	Nylon fabric back Nylon fabric teeth Antistatic Nylon fabric Transparent FDA compound

TOOTH PROFILE ACCORDING TO ISO 17396

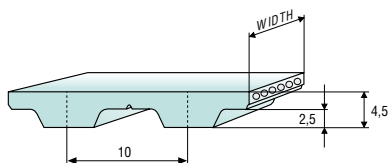

TOOTH RESISTANCE

RPM (1/min)	0	20	40	60	80	100	200	300	400	500	750	1000
F _{p spec} (N/cm)	36	34	34	33	32	31	29	27	26	25	23	22

TRACTION RESISTANCE

CORD MATERIAL	BELT WIDTH (MM)	200	250	300	400	450	500
Kevlar	Max Traction Load (N)	8530	10475	12570	16910	19005	20950
	Breaking Strength (N)	29855	36665	43995	69185	66520	73330
	Elongation at MTL (mm/m)	8	8	8	8	8	8

Average values



MEGALINEAR

T10 WIDE OPEN-ENDED

FLEXION RESISTANCE

	Z _{MIN}	IDLER MIN DIA (MM)	Z _{MIN}	IDLER MIN DIA (MM)
Kevlar cords	20	60	15	60

JOINED BELT INFORMATION:

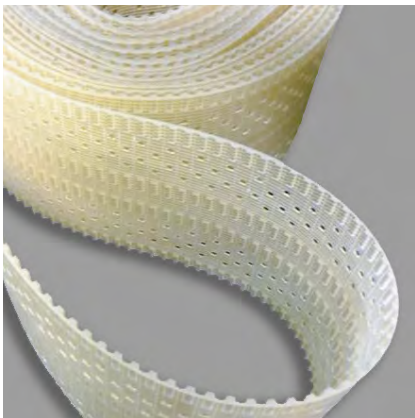

- Traction and tooth resistances = 50% less than open-ended
- Joined belt can be used only in conveyor systems
- Rolls with NFT and NFB can be joined too
- Minimum diameters according above table

PULLEYS

(FOR MORE DETAILS PLEASE SEE OUR PULLEYS CATALOGUE)

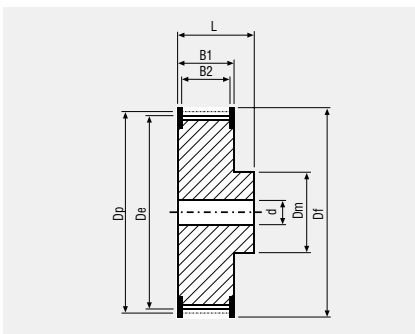

N° TEETH	DP	DE
12	38,20	36,35
14	44,56	42,71
15	47,75	45,90
16	50,93	49,08
18	57,30	55,45
19	60,48	58,63
20	63,66	61,81
22	70,03	68,18
24	76,39	74,55
25	79,58	77,73

N° TEETH	DP	DE
26	82,76	80,91
27	85,94	84,10
28	89,13	87,28
30	95,49	93,65
32	101,86	100,01
36	114,59	112,74
40	127,32	125,48
44	140,06	138,21
48	152,79	150,94
60	190,99	189,14

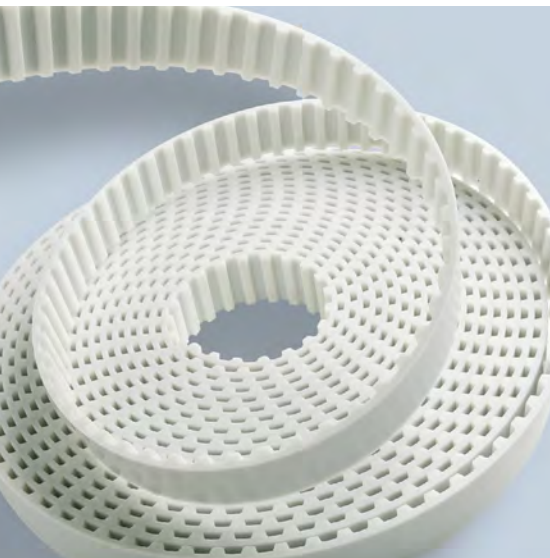

MEGALINEAR

T20 OPEN-ENDED

STANDARD WIDTHS (mm)	25	32	50	75	100	150
Weight (gr/m)	185	235	370	550	735	1095

Standard compound	white polyurethane thermoplastic 92 ShA
Standard back cover	none
Standard tooth cover	none
Standard cords	S and Z torsion zinked steel
Standard width tolerance	+/- 1 mm
Standard thickness	8 +/- 0,45 mm
Standard length tolerance	+/- 0,8 mm/m
Standard roll length	100 m

Nylon fabric back
Nylon fabric teeth
Antistatic nylon fabric
Transparent FDA compound
AVAFC 60/70/85 ShA
APL
Fishbone
Ribbed
Cleats

Belt options on request
with minimum quantity

TOOTH PROFILE ACCORDING TO
ISO 17396

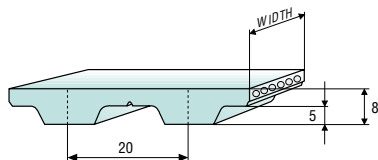

Different back coating materials see page 134

TOOTH RESISTANCE

RPM (1/min)	0	20	40	60	80	100	200	300	400	500	750	1000	1500	2000	3000	4000	5000
F _{p spec} (N/cm)	102	98	95	93	91	89	81	76	72	68	62	57	50	45	38	33	29

Minimum suggested number of teeth in clamp for linear movement: 7

TRACTION RESISTANCE

CORD MATERIAL	BELT WIDTH (MM)	25	32	50	75	100	150
Steel	Max Traction Load (N)	3800	4750	8075	13000	17500	28225
	Breaking Strength (N)	15200	19000	32300	49400	66500	98800
	Elongation at MTL (mm/m)	4	4	4	4	4	4
Kevlar	Max Traction Load (N)	5045	6730	10935	17715	23915	39425
	Breaking Strength (N)	20195	26925	43755	67315	90875	138000
	Elongation at MTL (mm/m)	8	8	8	8	8	8
HP	Max Traction Load (N)	5190	6920	11245	18210	24580	40530
	Breaking Strength (N)	20760	27680	44980	69200	93420	141860
	Elongation at MTL (mm/m)	4	4	4	4	4	4
HF	Max Traction Load (N)	4240	5300	9090	14505	-	-
	Breaking Strength (N)	16960	21200	36040	55120	-	-
	Elongation at MTL (mm/m)	5	5	5	5	-	-
HPF	Max Traction Load (N)	5775	7700	12510	20260	-	-
	Breaking Strength (N)	23100	30800	50050	77000	-	-
	Elongation at MTL (mm/m)	5	5	5	5	-	-
Stainless	Max Traction Load (N)	3175	3970	6745	-	-	-
	Breaking Strength (N)	12700	15880	26995	-	-	-
	Elongation at MTL (mm/m)	3,8	3,8	3,8	-	-	-

Average values

MEGALINEAR



MEGALINEAR

T20 OPEN-ENDED

FLEXION RESISTANCE

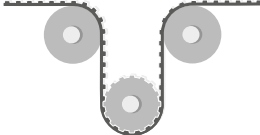
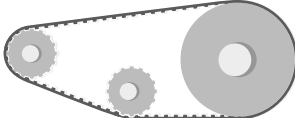
			
	Z_{MIN}	Z_{MIN} IDLER MIN DIA (MM)	Z_{MIN} IDLER MIN DIA (MM)
Standard steel cords	15	25 120	15 120
Kevlar cords	15	25 120	15 120
High Power cords	20	25 150	20 150
High Flexibility cords	15	20 120	15 120
High Power Flexible cords	18	25 120	18 120
Stainless steel cords	20	25 130	20 130

JOINED BELT INFORMATION:

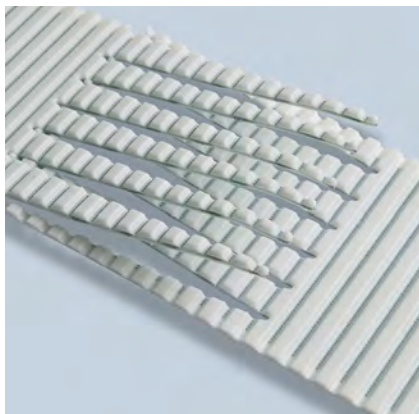

- Minimum splice length 900 mm
- Traction and tooth resistances = 50% less than open-ended
- Joined belt can be used only in conveyor systems
- Rolls with NFT, NFB, AVAFC and APL can be joined too
- Minimum diameters according above table
- For coated belts, minimum diameters on page 134

PULLEYS

(FOR MORE DETAILS PLEASE SEE OUR PULLEYS CATALOGUE)

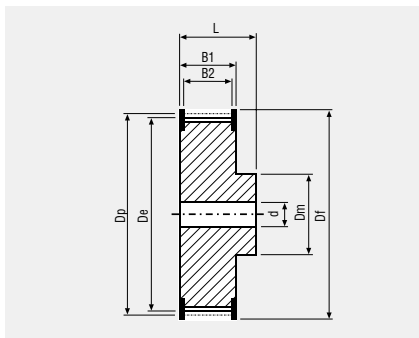

N° TEETH	DP	DE
15	95,54	92,69
18	114,59	111,73
20	127,32	124,47
22	140,06	137,20
24	152,79	149,93
25	159,15	156,30

N° TEETH	DP	DE
30	190,99	188,13
32	203,72	200,86
36	229,18	226,33
40	254,65	251,80
48	305,58	302,73
60	381,97	379,12

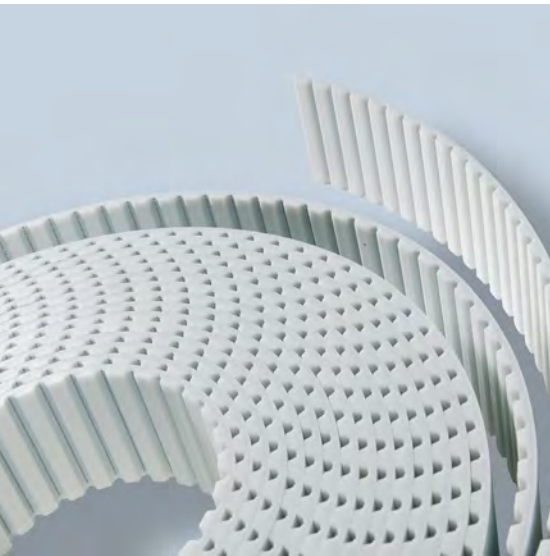

MEGALINEAR

AT3 OPEN-ENDED

STANDARD WIDTHS (mm)	10	20	25	50
Weight (gr/m)	20	45	60	115

Standard compound	white polyurethane thermoplastic 92 ShA
Standard back cover	none
Standard tooth cover	none
Standard cords	S and Z torsion zinked steel
Standard width tolerance	+/- 0,5 mm
Standard thickness	1,9 +/- 0,1 mm
Standard length tolerance	+/- 0,5 mm/m
Standard roll length	100 m
Belt options on request with minimum quantity	Nylon fabric back Nylon fabric teeth Antistatic nylon fabric

Different back coating materials see page 134

TOOTH PROFILE ACCORDING TO ISO 17396

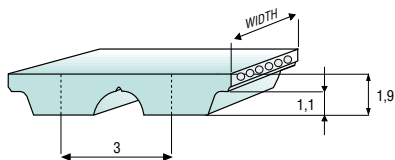

TOOTH RESISTANCE

RPM (1/min)	0	20	40	60	80	100	200	300	400	500	750	1000	1500	2000	3000	4000	5000	8000
F _{p spec} (N/cm)	24	24	24	23	23	23	22	21	21	20	19	18	16	15	14	13	12	10

Minimum suggested number of teeth in clamp for linear movement: 7

TRACTION RESISTANCE

CORD MATERIAL	BELT WIDTH (MM)	10	20	25	50
Steel	Max Traction Load (N)	410	820	1065	2170
	Breaking Strength (N)	1640	3280	4260	8690
	Elongation at MTL (mm/m)	4	4	4	4

Average values



MEGALINEAR

AT3 OPEN-ENDED

FLEXION RESISTANCE

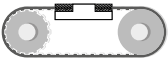
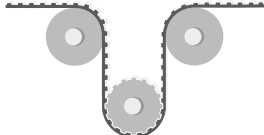
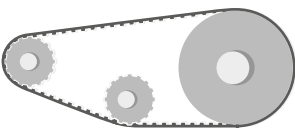
			
	Z_{MIN}	Z_{MIN} IDLER MIN DIA (MM)	Z_{MIN} IDLER MIN DIA (MM)
Standard steel cords	20	25 30	20 30

JOINED BELT INFORMATION:



- Minimum splice length 900 mm
- Traction and tooth resistances = 50% less than open-ended
- Joined belt can be used only in conveyor systems
- Rolls with NFT and NFB can be joined too
- Minimum diameters according above table
- For coated belts, minimum diameters on page 134

PULLEYS

(FOR MORE DETAILS PLEASE SEE OUR PULLEYS CATALOGUE)

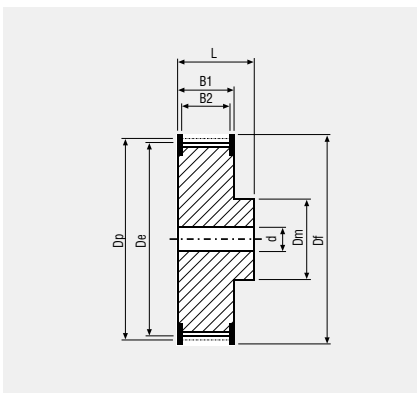

N° TEETH	DP	DE	N° TEETH	DP	DE
20	19,10	18,69	36	34,39	33,97
22	21,01	20,6	40	38,21	37,79
24	22,92	22,51	44	42,03	41,61
25	23,88	23,46	45	42,99	42,56
27	25,79	25,37	48	45,85	45,43
30	28,66	28,24	60	57,32	58,69
32	30,57	30,15	72	68,78	68,34

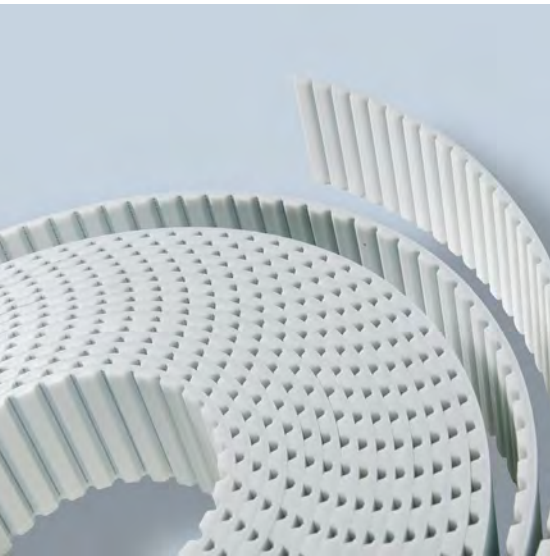

MEGALINEAR

AT5 OPEN-ENDED

STANDARD WIDTHS (mm)	6	10	16	25	32	50	75	100
Weight (gr/m)	20	35	50	80	105	165	245	340

Standard compound	white polyurethane thermoplastic 92 ShA
Standard back cover	none
Standard tooth cover	none
Standard cords	S and Z torsion zinked steel
Standard width tolerance	+/- 0,5 mm
Standard thickness	2,7 +/- 0,2 mm
Standard length tolerance	+/- 0,8 mm/m
HP+HPF cord length tolerance	+0/- 0,8 mm/m
Standard roll length	100 m
Belt options on request with minimum quantity	Nylon fabric back Nylon fabric teeth Antistatic nylon fabric Transparent FDA compound AVAFC 60/70/85 ShA APL Cleats

TOOTH PROFILE ACCORDING TO ISO 17396

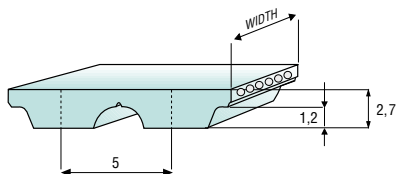

Different back coating materials see page 134

TOOTH RESISTANCE

RPM (1/min)	0	20	40	60	80	100	200	300	400	500	750	1000	1500	2000	3000	4000	5000	8000
F _{p spec} (N/cm)	35	35	35	34	34	34	32	31	30	29	27	26	24	22	19	18	16	13

Minimum suggested number of teeth in clamp for linear movement: 7

TRACTION RESISTANCE

CORD MATERIAL	BELT WIDTH (MM)	6	10	16	25	32	50	75	100
Steel	Max Traction Load (N)	400	670	1070	1805	2275	3750	5145	6910
	Breaking Strength (N)	1605	2680	4285	7235	9110	15005	19560	26260
	Elongation at MTL (mm/m)	4	4	4	4	4	4	4	4
Kevlar	Max Traction Load (N)	490	820	1315	2225	2800	4615	6335	8505
	Breaking Strength (N)	1975	3295	5275	8900	11210	18465	24075	32320
	Elongation at MTL (mm/m)	8	8	8	8	8	8	8	8
HP	Max Traction Load (N)	-	840	1470	2415	3045	5040	-	-
	Breaking Strength (N)	-	3360	5880	9660	12180	20160	-	-
	Elongation at MTL (mm/m)	-	4	4	4	4	4	-	-
HF	Max Traction Load (N)	-	685	1100	1855	2335	3850	-	-
	Breaking Strength (N)	-	2750	4400	7425	9350	15400	-	-
	Elongation at MTL (mm/m)	-	5	5	5	5	5	-	-
HPF	Max Traction Load (N)	-	880	1540	2530	3190	5280	-	-
	Breaking Strength (N)	-	3520	6160	10120	12760	21120	-	-
	Elongation at MTL (mm/m)	-	5	5	5	5	5	-	-
Stainless	Max Traction Load (N)	350	590	940	1590	-	-	-	-
	Breaking Strength (N)	1415	2360	3775	6370	-	-	-	-
	Elongation at MTL (mm/m)	3,8	3,8	3,8	3,8	-	-	-	-

Average values

MEGALINEAR



MEGALINEAR

AT5 OPEN-ENDED

FLEXION RESISTANCE

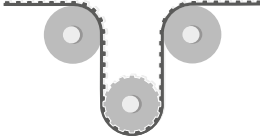
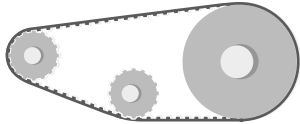
			
	Z_{MIN}	Z_{MIN} IDLER MIN DIA (MM)	Z_{MIN} IDLER MIN DIA (MM)
Standard steel cords	15	15 60	15 25
Kevlar cords	15	25 60	15 25
High Power cords	25	25 60	25 40
High Flexibility cords	12	13 40	12 25
High Power Flexible cords	20	24 40	20 40
Stainless steel cords	15	18 65	15 60

JOINED BELT INFORMATION:



- Minimum splice length 900 mm
- Traction and tooth resistances = 50% less than open-ended
- Joined belt can be used only in conveyor systems
- Rolls with NFT, NFB, AVAFC and APL can be joined too
- Minimum diameters according above table
- For coated belts, minimum diameters on page 134

PULLEYS

(FOR MORE DETAILS PLEASE SEE OUR PULLEYS CATALOGUE)

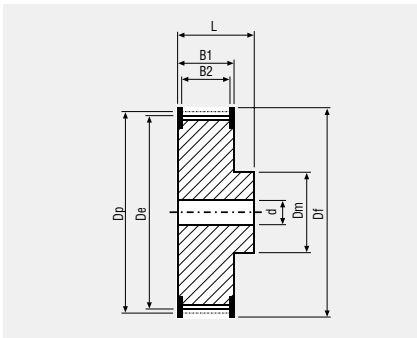

N° TEETH	DP	DE
15	23,87	22,64
16	25,46	24,24
18	28,65	27,42
19	30,24	29,01
20	31,83	30,60
22	35,01	33,79
24	38,20	36,97
25	39,79	38,56
26	41,38	40,15
27	42,97	41,74

N° TEETH	DP	DE
28	44,56	43,33
30	47,75	46,52
32	50,93	49,70
36	57,30	56,07
40	63,66	62,43
42	66,85	65,62
44	70,03	68,80
48	76,39	75,17
60	95,49	94,27

MEGALINEAR

MEGAECO BIOBASED AT5

STANDARD WIDTHS (mm)	6	10	16	25	32	50	75	100
Weight (gr/m)	20	35	50	80	105	165	245	340

Standard compound	green polyurethane thermoplastic 90 ShA
Standard back cover	none
Standard tooth cover	none
Standard cords	S and Z torsion zinked steel
Standard width tolerance	+/- 0,5 mm
Standard thickness	2,7 +/- 0,2 mm
Standard length tolerance	+/- 0,8 mm/m
Standard roll length	100 m

MEGALINEAR MegaEco Biobased is the eco-friendly and impact-reducing belt solutions with no compromise on the quality of performance.



TOOTH PROFILE ACCORDING TO ISO 17396

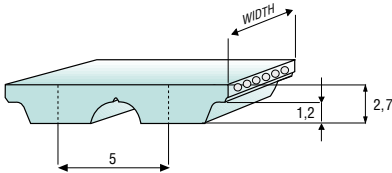

TOOTH RESISTANCE

RPM (1/min)	0	20	40	60	80	100	200	300	400	500	750	1000	1500	2000	3000	4000	5000	8000
F _{p spec} (N/cm)	35	35	35	34	34	34	32	31	30	29	27	26	24	22	19	18	16	13

Minimum suggested number of teeth in clamp for linear movement: 7

TRACTION RESISTANCE

CORD MATERIAL	BELT WIDTH (MM)	6	10	16	25	32	50	75	100
Steel	Max Traction Load (N)	400	670	1070	1805	2275	3750	5145	6910
	Breaking Strength (N)	1605	2680	4285	7235	9110	15005	19560	26260
	Elongation at MTL (mm/m)	4	4	4	4	4	4	4	4

Average values

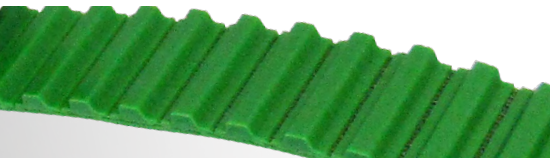

MEGALINEAR

MEGAECO BIOBASED AT5

FLEXION RESISTANCE

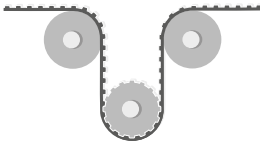
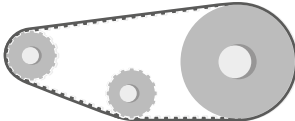
			
	Z_{MIN}	Z_{MIN} IDLER MIN DIA (MM)	Z_{MIN} IDLER MIN DIA (MM)
Standard steel cords	15	15 60	15 25

JOINED BELT INFORMATION:



- Minimum splice length 900 mm
- Traction and tooth resistances = 50% less than open-ended
- Rolls with NFT, NFB, AVAFC and APL can be joined too
- Minimum diameters according above table

PULLEYS

(FOR MORE DETAILS PLEASE SEE OUR PULLEYS CATALOGUE)

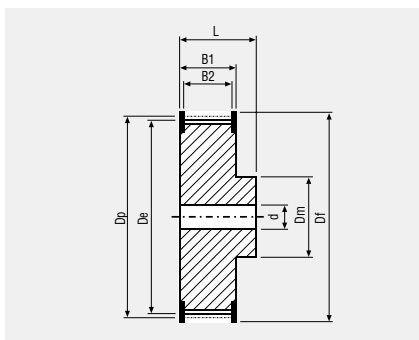

N° TEETH	DP	DE
15	23,87	22,64
16	25,46	24,24
18	28,65	27,42
19	30,24	29,01
20	31,83	30,60
22	35,01	33,79
24	38,20	36,97
25	39,79	38,56
26	41,38	40,15
27	42,97	41,74

N° TEETH	DP	DE
28	44,56	43,33
30	47,75	46,52
32	50,93	49,70
36	57,30	56,07
40	63,66	62,43
42	66,85	65,62
44	70,03	68,80
48	76,39	75,17
60	95,49	94,27

MEGALINEAR

AT10 OPEN-ENDED

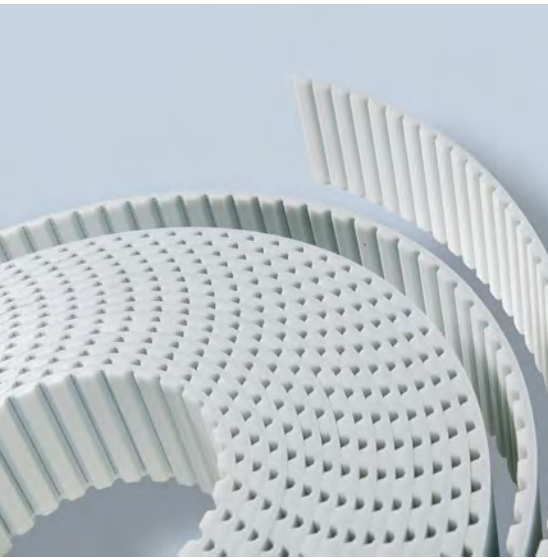

STANDARD WIDTHS (mm)	16	25	32	50	75	100	150
Weight (gr/m)	90	160	185	290	435	580	890

Standard compound	white polyurethane thermoplastic 92 ShA
Standard back cover	none
Standard tooth cover	none
Standard cords	S and Z torsion zinked steel
Standard width tolerance	+/- 0,5 mm
Standard thickness	4,5 +/- 0,3 mm
Standard length tolerance	+/- 0,8 mm/m
HP+HPF cord length tolerance	+0/- 0,8 mm/m
Standard roll length	100 m

TOOTH PROFILE ACCORDING TO ISO 17396

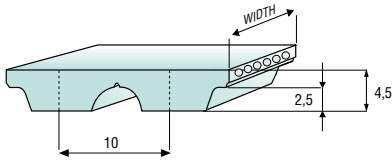

Belt options on request with minimum quantity

- Nylon fabric back**
- Nylon fabric teeth**
- Antistatic nylon fabric**
- Transparent FDA compound**
- AVAFC 60/70/85 ShA**
- APL**
- Fishbone**
- Ribbed**
- Cleats**

Different back coating materials see page 134

TOOTH RESISTANCE

RPM (1/min)	0	20	40	60	80	100	200	300	400	500	750	1000	1500	2000	3000	4000	5000	8000
F _{p spec} (N/cm)	83	80	80	80	78	77	73	69	67	65	58	55	48	44	38	33	30	22

Minimum suggested number of teeth in clamp for linear movement: 7

TRACTION RESISTANCE

CORD MATERIAL	BELT WIDTH (MM)	16	25	32	50	75	100	150
Steel	Max Traction Load (N)	2270	4000	5160	8590	13800	18600	30600
	Breaking Strength (N)	9100	16100	20200	34300	52500	70700	105000
	Elongation at MTL (mm/m)	4	4	4	4	4	4	4
Kevlar	Max Traction Load (N)	2945	5045	6730	10935	17715	23915	39425
	Breaking Strength (N)	11780	20195	26925	43755	67315	90875	138000
	Elongation at MTL (mm/m)	8	8	8	8	8	8	8
HP	Max Traction Load (N)	3460	5190	6920	11245	18210	24580	40530
	Breaking Strength (N)	13840	20760	27680	44980	69200	93420	141860
	Elongation at MTL (mm/m)	4	4	4	4	4	4	4
HF	Max Traction Load (N)	2385	4240	5300	9010	14505	19525	31495
	Breaking Strength (N)	9540	16960	21200	36040	55120	74200	110240
	Elongation at MTL (mm/m)	5	5	5 b	5	5	5	5
HPF	Max Traction Load (N)	3850	5775	7700	12510	20260	27355	45100
	Breaking Strength (N)	15400	23100	30800	50050	77000	103950	157850
	Elongation at MTL (mm/m)	5	5	5	5	5	5	5
Stainless	Max Traction Load (N)	1785	3175	3970	6745	-	-	-
	Breaking Strength (N)	7145	12700	15880	26995	-	-	-
	Elongation at MTL (mm/m)	3,8	3,8	3,8	3,8	-	-	-

Average values

MEGALINEAR



MEGALINEAR

AT10 OPEN-ENDED

FLEXION RESISTANCE

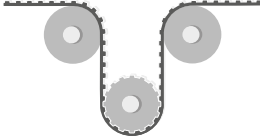
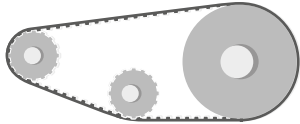
			
	Z_{MIN}	Z_{MIN} IDLER MIN DIA (MM)	Z_{MIN} IDLER MIN DIA (MM)
Standard steel cords	15	20 120	15 50
Kevlar cords	15	20 120	15 50
High Power cords	25	25 150	25 80
High Flexibility cords	15	20 80	15 50
High Power Flexible cords	16	20 100	16 60
Stainless steel cords	19	25 110	19 110

JOINED BELT INFORMATION:



- Minimum splice length 900 mm
- Traction and tooth resistances = 50% less than open-ended
- Joined belt can be used only in conveyor systems
- Rolls with NFT, NFB, AVAFC and APL can be joined too
- Minimum diameters according above table
- For coated belts, minimum diameters on page 134

PULLEYS

(FOR MORE DETAILS PLEASE SEE OUR PULLEYS CATALOGUE)

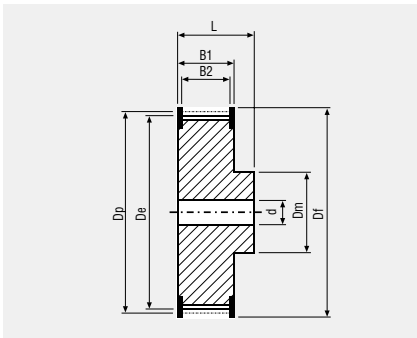

N° TEETH	DP	DE
15	47,75	45,90
16	50,93	49,08
18	57,30	55,45
19	60,48	58,63
20	63,66	61,81
22	70,03	68,18
24	76,39	74,55
25	79,58	77,73
26	82,76	80,91

N° TEETH	DP	DE
27	85,94	84,10
28	89,13	87,28
30	95,49	93,65
32	101,86	100,01
36	114,59	112,74
40	127,32	125,48
44	140,06	138,21
48	152,79	150,94
60	190,99	189,14

MEGALINEAR

MEGAECO BIOBASED AT10

STANDARD WIDTHS (mm)	16	25	32	50	75	100	150
Weight (gr/m)	90	160	185	290	435	580	890

Standard compound	green polyurethane thermoplastic 90 ShA
Standard back cover	none
Standard tooth cover	none
Standard cords	S and Z torsion zinked steel
Standard width tolerance	+/- 0,5 mm
Standard thickness	4,5 +/- 0,3 mm
Standard length tolerance	+/- 0,8 mm/m
Standard roll length	100 m

MEGALINEAR MegaEco Biobased is the eco-friendly and impact-reducing belt solutions with no compromise on the quality of performance.



TOOTH PROFILE ACCORDING TO ISO 17396

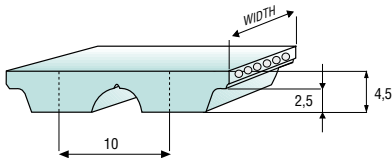

TOOTH RESISTANCE

RPM (1/min)	0	20	40	60	80	100	200	300	400	500	750	1000	1500	2000	3000	4000	5000	8000
F _{p spec} (N/cm)	83	80	80	80	78	77	73	69	67	65	58	55	48	44	38	33	30	22

Minimum suggested number of teeth in clamp for linear movement: 7

TRACTION RESISTANCE

CORD MATERIAL	BELT WIDTH (MM)	16	25	32	50	75	100	150
Steel	Max Traction Load (N)	2270	4000	5160	8590	13800	18600	30600
	Breaking Strength (N)	9100	16100	20200	34300	52500	70700	105000
	Elongation at MTL (mm/m)	4	4	4	4	4	4	4

Average values

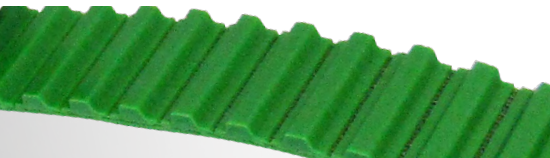

MEGALINEAR

MEGAECO BIOBASED AT10

FLEXION RESISTANCE

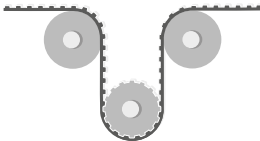
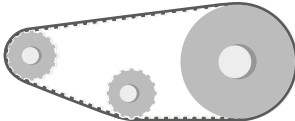
			
	Z_{MIN}	Z_{MIN} IDLER MIN DIA (MM)	Z_{MIN} IDLER MIN DIA (MM)
Standard steel cords	15	20 120	15 50



JOINED BELT INFORMATION:

- Minimum splice length 900 mm
- Traction and tooth resistances = 50% less than open-ended
- Joined belt can be used only in conveyor systems
- Minimum diameters according above table

PULLEYS

(FOR MORE DETAILS PLEASE SEE OUR PULLEYS CATALOGUE)

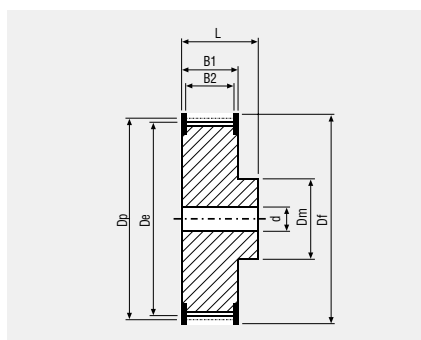

N° TEETH	DP	DE	N° TEETH	DP	DE
15	47,75	45,90	27	85,94	84,10
16	50,93	49,08	28	89,13	87,28
18	57,30	55,45	30	95,49	93,65
19	60,48	58,63	32	101,86	100,01
20	63,66	61,81	36	114,59	112,74
22	70,03	68,18	40	127,32	125,48
24	76,39	74,55	44	140,06	138,21
25	79,58	77,73	48	152,79	150,94
26	82,76	80,91	60	190,99	189,14

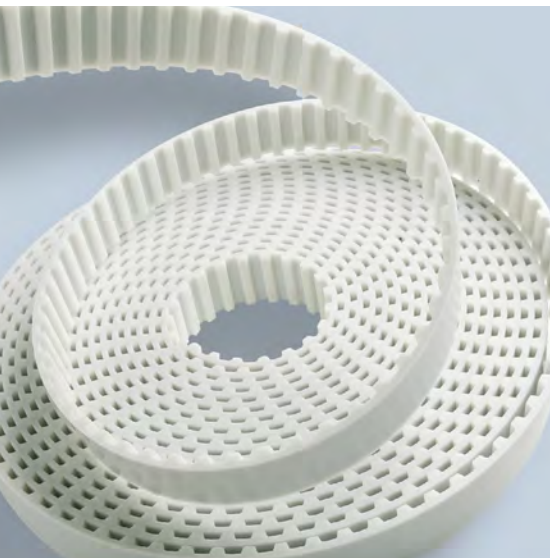

MEGALINEAR

AT10 WITHOUT GAP OPEN-ENDED

STANDARD WIDTHS (mm)	25	32	50	75	100
Weight (gr/m)	160	205	320	480	640

Standard compound	white polyurethane thermoplastic 92 ShA
Standard back cover	none
Standard tooth cover	none
Standard cords	S and Z torsion zinked steel
Standard width tolerance	+/- 0,5 mm
Standard thickness	4,5 +/- 0,3 mm
Standard length tolerance	+/- 0,8 mm/m
Standard roll length	100 m

TOOTH PROFILE ACCORDING TO ISO 17396

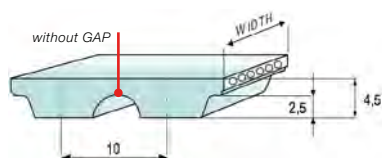

TOOTH RESISTANCE

RPM (1/min)	0	20	40	60	80	100	200	300	400	500	750	1000	1500	2000	3000	4000	5000	8000
F _{p spec} (N/cm)	74	72	71	71	70	69	65	62	60	58	53	50	44	40	35	30	27	20

Minimum suggested number of teeth in clamp for linear movement: 7

TRACTION RESISTANCE

CORD MATERIAL	BELT WIDTH (MM)	25	32	50	75	100
		Max Traction Load (N)	3560	4510	7835	12750
Steel	Breaking Strength (N)	14250	18050	31350	48450	65550
	Elongation at MTL (mm/m)	4	4	4	4	4

Average values



MEGALINEAR

AT10 WITHOUT GAP OPEN-ENDED

FLEXION RESISTANCE

	Z_{MIN}	Z_{MIN}	Z_{MIN}
		IDLER MIN DIA (MM)	IDLER MIN DIA (MM)
Standard steel cords	15	20	15
		120	50

PULLEYS

(FOR MORE DETAILS PLEASE SEE OUR PULLEYS CATALOGUE)

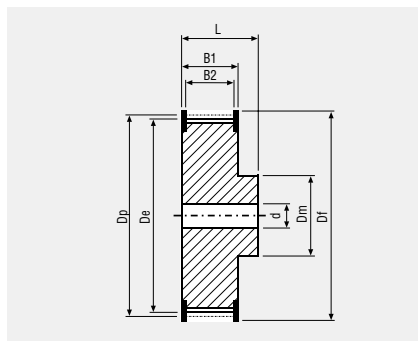

N° TEETH	DP	DE
15	47,75	45,90
16	50,93	49,08
18	57,30	55,45
19	60,48	58,63
20	63,66	61,81
22	70,03	68,18
24	76,39	74,55
25	79,58	77,73
26	82,76	80,91

N° TEETH	DP	DE
27	85,94	84,10
28	89,13	87,28
30	95,49	93,65
32	101,86	100,01
36	114,59	112,74
40	127,32	125,48
44	140,06	138,21
48	152,79	150,94
60	190,99	189,14

TYPICAL APPLICATION: CAR WASHING MACHINE



MEGALINEAR

MEGAC4T AT10 OPEN-ENDED

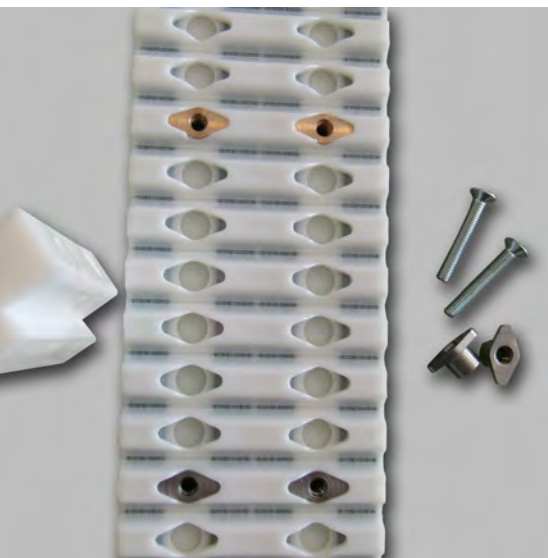
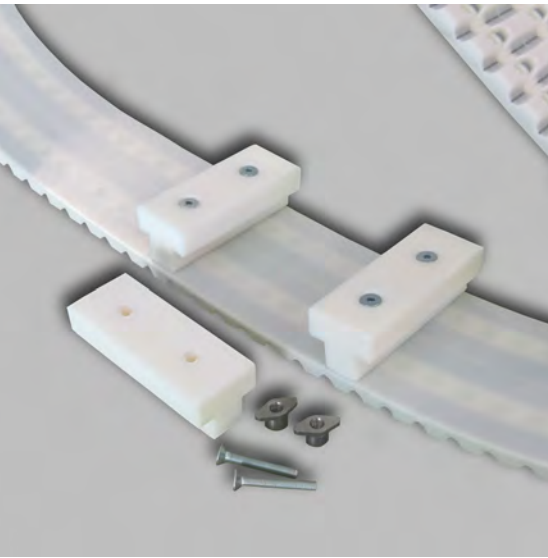

STANDARD WIDTHS (mm)	25	50	75	100
Weight (gr/m)	125	250	375	500

Standard compound	white polyurethane thermoplastic 92 ShA
Standard back cover	none
Standard tooth cover	none
Standard cords	S and Z torsion zinked steel
Standard width tolerance	+/- 0,5 mm
Standard thickness	4,5 +/- 0,3 mm
Standard length tolerance	+/- 0,8 mm/m
Standard roll length	100 m
Standard inserts	brass and stainless steel (M4)

TOOTH RESISTANCE

RPM (1/min)	0	20	40	60	80	100	200	300	400
F _{p spec} (N/cm)	60	58	57	57	56	55	52	50	48

TOOTH RESISTANCE (CONT.)

RPM (1/min)	500	750	1000	1500	2000	3000	4000	5000	8000
F _{p spec} (N/cm)	47	42	40	34	30	27	23	21	15

TOOTH PROFILE ACCORDING TO ISO 17396

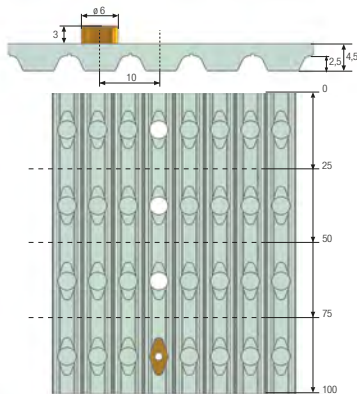

TRACTION RESISTANCE

CORD MATERIAL	BELT WIDTH (MM)	25	50	75	100
Steel	Max Traction Load (N)	2850	5700	9000	12000
	Breaking Strength (N)	11400	22800	34200	45600
	Elongation at MTL (mm/m)	4	4	4	4

Average values

MEGALINEAR

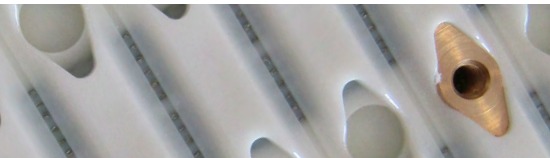

MEGALINEAR

MEGAC4T AT10 OPEN-ENDED

FLEXION RESISTANCE

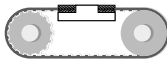
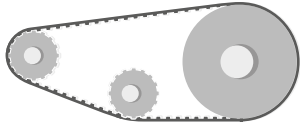
		
	Z_{MIN}	Z_{MIN} IDLER MIN DIA (MM)
Standard steel cords	25	25 80

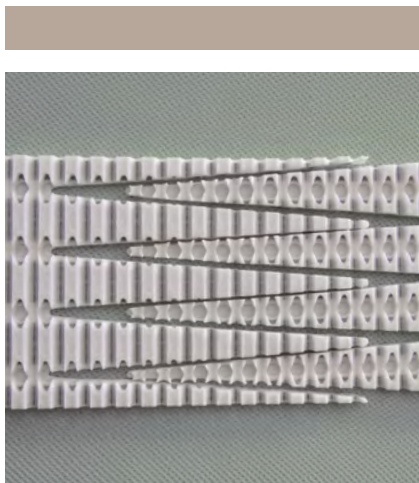

JOINED BELT INFORMATION:

- Minimum splice length 900 mm
- Traction and tooth resistances = 50% less than open-ended
- Joined belt can be used only in conveyor systems
- Minimum diameters according above table

PULLEYS

(FOR MORE DETAILS PLEASE SEE OUR PULLEYS CATALOGUE)

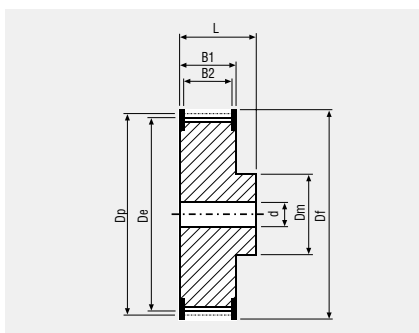

N° TEETH	DP	DE
25	79,58	77,73
26	82,76	80,91
27	85,94	84,10
28	89,13	87,28
30	95,49	93,65
32	101,86	100,01

N° TEETH	DP	DE
36	114,59	112,74
40	127,32	125,48
44	140,06	138,21
48	152,79	150,94
60	190,99	189,14

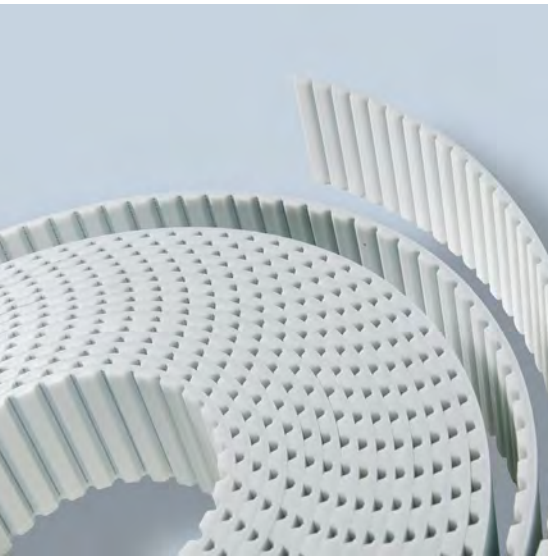

MEGALINEAR

AT20 OPEN-ENDED

STANDARD WIDTHS (mm)	25	32	50	75	100	150	200
Weight (gr/m)	225	310	480	720	960	1425	1935

Standard compound	white polyurethane thermoplastic 92 ShA
Standard back cover	none
Standard tooth cover	none
Standard cords	S and Z torsion zinked steel
Standard width tolerance	+/- 1 mm
Standard thickness	8 +/- 0,45 mm
Standard length tolerance	+/- 0,8 mm/m
HP+HPF cord length tolerance	+0/- 0,8 mm/m
Standard roll length	100 m

Belt options on request with minimum quantity	Nylon fabric back Nylon fabric teeth Antistatic nylon fabric Transparent FDA compound AVAFC 60/70/85 ShA APL Fishbone Ribbed Cleats
---	--

TOOTH PROFILE ACCORDING TO ISO 17396

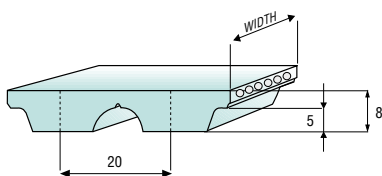

Different back coating materials see page 134

TOOTH RESISTANCE

RPM (1/min)	0	20	40	60	80	100	200	300	400	500	750	1000	1500	2000	3000	4000	5000
F _{p spec} (N/cm)	147	144	142	139	137	135	126	119	112	107	97	88	76	67	58	43	35

Minimum suggested number of teeth in clamp for linear movement: 7

TRACTION RESISTANCE

CORD MATERIAL	BELT WIDTH (MM)	25	32	50	75	100	150	200
Steel	Max Traction Load (N)	5190	6920	11245	18210	24580	40530	53380
	Breaking Strength (N)	20760	27680	44980	69200	93420	141860	186840
	Elongation at MTL (mm/m)	4	4	4	4	4	4	4
Kevlar	Max Traction Load (N)	5045	6730	10935	17715	23915	39425	51930
	Breaking Strength (N)	20195	26925	43755	67315	90875	138000	181755
	Elongation at MTL (mm/m)	8	8	8	8	8	8	8
HP	Max Traction Load (N)	-	10400	16000	25260	34525	56685	74970
	Breaking Strength (N)	-	41600	64000	96000	131200	198400	262400
	Elongation at MTL (mm/m)	-	4	4	4	4	4	4
HF	Max Traction Load (N)	5775	7700	12510	20260	27355	45100	59400
	Breaking Strength (N)	23100	30800	50050	77000	103950	157850	207900
	Elongation at MTL (mm/m)	5	5	5	5	5	5	5

Average values



MEGALINEAR

AT20 OPEN-ENDED

FLEXION RESISTANCE

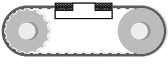
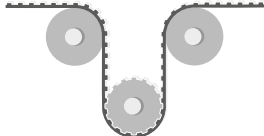
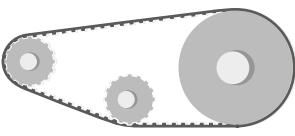
			
	Z_{MIN}	Z_{MIN} IDLER MIN DIA (MM)	Z_{MIN} IDLER MIN DIA (MM)
Standard steel cords	18	25 180	18 120
Kevlar cords	18	25 180	18 120
High Power cords	25	25 250	25 160
High Flexibility cords	18	25 150	18 120

JOINED BELT INFORMATION:



- Minimum splice length 900 mm
- Traction and tooth resistances = 50% less than open-ended
- Joined belt can be used only in conveyor systems
- Rolls with NFT, NFB, AVAFC and APL can be joined too
- Minimum diameters according above table
- For coated belts, minimum diameters on page 134

PULLEYS

(FOR MORE DETAILS PLEASE SEE OUR PULLEYS CATALOGUE)

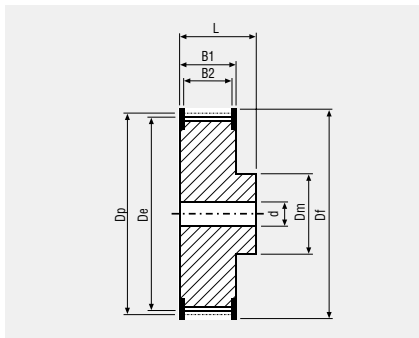

N° TEETH	DP	DE
18	114,59	111,73
20	127,32	124,47
22	140,06	137,20
24	152,79	149,93
25	159,15	156,30
30	190,99	188,13

N° TEETH	DP	DE
32	203,72	200,86
36	229,18	226,33
40	254,65	251,80
48	305,58	302,73
60	381,97	379,12

MEGALINEAR

MTD3 OPEN-ENDED



STANDARD WIDTHS (mm)	10	20	25	50
Weight (gr/m)	20	45	60	115

Standard compound	white polyurethane thermoplastic 92 ShA
Standard back cover	none
Standard tooth cover	none
Standard cords	S and Z torsion zinked steel
Standard width tolerance	+/- 0,3 mm
Standard thickness	2,2 +/- 0,15 mm
Standard length tolerance	+/- 0,5 mm/m
Standard roll length	100 m
Belt options on request with minimum quantity	Nylon fabric back Nylon fabric teeth Antistatic nylon fabric Transparent FDA compound

Different back coating materials see page 134

TOOTH PROFILE ACCORDING TO ISO 13050

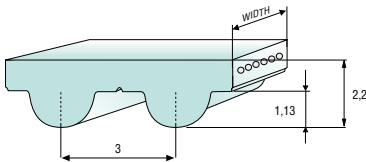

TOOTH RESISTANCE

RPM (1/min)	0	20	40	60	80	100	200	300	400	500	750	1000	1500	2000	3000	4000	5000	8000
F _{p spec} (N/cm)	23	23	22	22	22	22	21	20	20	19	18	17	16	15	13	12	11	9

Minimum suggested number of teeth in clamp for linear movement: 7

TRACTION RESISTANCE

CORD MATERIAL	BELT WIDTH (MM)	10	20	25	50
Steel	Max Traction Load (N)	410	820	1065	2170
	Breaking Strength (N)	1640	3280	4260	8690
	Elongation at MTL (mm/m)	4	4	4	4

Average values



MEGALINEAR

MTD3 OPEN-ENDED

FLEXION RESISTANCE

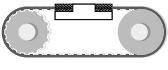
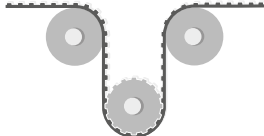
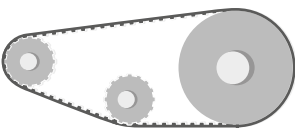
			
	Z_{MIN}	Z_{MIN} IDLER MIN DIA (MM)	Z_{MIN} IDLER MIN DIA (MM)
Standard steel cords	20	20 30	20 30

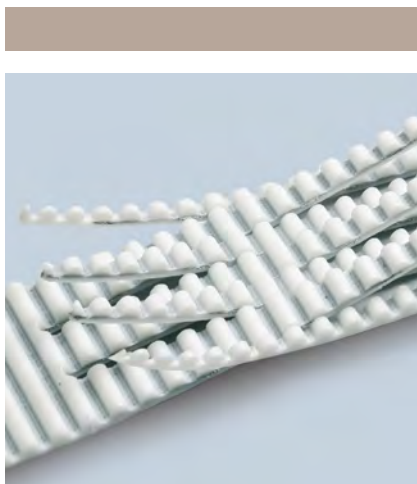

JOINED BELT INFORMATION:

- Minimum splice length 900 mm
- Traction and tooth resistances = 50% less than open-ended
- Joined belt can be used only in conveyor systems
- Rolls with NFT and NFB can be joined too
- Minimum diameters according above table
- For coated belts, minimum diameters on page 134

PULLEYS

(FOR MORE DETAILS PLEASE SEE OUR PULLEYS CATALOGUE)

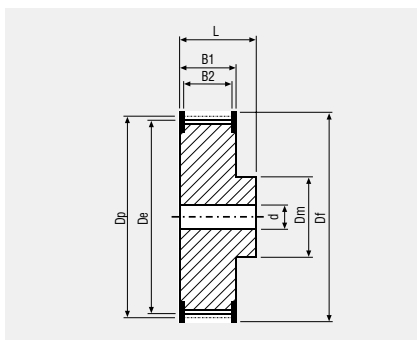

N° TEETH	DP	DE	N° TEETH	DP	DE
20	19,10	18,34	32	30,56	29,80
21	20,05	19,29	36	34,38	33,62
22	21,01	20,25	40	38,20	37,44
24	22,92	22,16	44	42,02	41,25
26	24,83	24,07	48	45,84	45,07
28	26,74	25,98	60	57,30	56,53
30	28,65	27,89	72	68,75	67,99

MEGALINEAR

MTD5 OPEN-ENDED



STANDARD WIDTHS (mm)	10	15	25	50
Weight (gr/m)	35	50	80	165

Standard compound	white polyurethane thermoplastic 92 ShA
Standard back cover	none
Standard tooth cover	none
Standard cords	S and Z torsion zinked steel
Standard width tolerance	+/- 0,5 mm
Standard thickness	3,6 +/- 0,2 mm
Standard length tolerance	+/- 0,8 mm/m
Standard roll length	100 m
Belt options on request with minimum quantity	Nylon fabric back Nylon fabric teeth Antistatic nylon fabric Cleats

Different back coating materials see page 134

TOOTH PROFILE ACCORDING TO ISO 13050

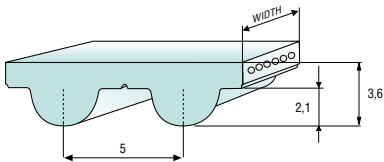

TOOTH RESISTANCE

RPM (1/min)	0	20	40	60	80	100	200	300	400	500	750	1000	1500	2000	3000	4000	5000	8000
F _{p spec} (N/cm)	34	34	33	33	33	32	31	30	29	28	26	25	23	21	19	17	16	13

Minimum suggested number of teeth in clamp for linear movement: 7

TRACTION RESISTANCE

CORD MATERIAL	BELT WIDTH (MM)	TRACTION RESISTANCE			
		10	20	25	50
Steel	Max Traction Load (N)	670	1005	1805	3750
	Breaking Strength (N)	2680	4020	7235	15005
	Elongation at MTL (mm/m)	4	4	4	4
Kevlar	Max Traction Load (N)	820	1235	2225	4615
	Breaking Strength (N)	3295	4945	8900	18465
	Elongation at MTL (mm/m)	8	8	8	8
Stainless	Max Traction Load (N)	590	885	1590	–
	Breaking Strength (N)	2360	3540	6370	–
	Elongation at MTL (mm/m)	3,8	3,8	3,8	–

Average values

MEGALINEAR

MTD5 OPEN-ENDED

FLEXION RESISTANCE

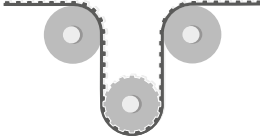
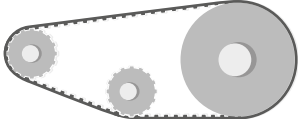
			
	Z _{MIN}	Z _{MIN} IDLER MIN DIA (MM)	Z _{MIN} IDLER MIN DIA (MM)
Standard steel cords	16	16 50	16 25
Kevlar cords	16	16 50	16 25
Stainless steel cords	18	20 65	18 65

JOINED BELT INFORMATION:



- Minimum splice length 900 mm
- Traction and tooth resistances = 50% less than open-ended
- Joined belt can be used only in conveyor systems
- Rolls with NFT and NFB can be joined too
- Minimum diameters according above table
- For coated belts, minimum diameters on page 134

PULLEYS

(FOR MORE DETAILS PLEASE SEE OUR PULLEYS CATALOGUE)

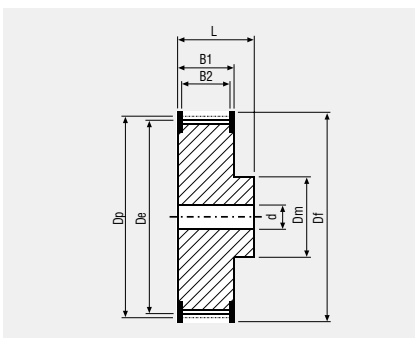

N° TEETH	DP	DE	N° TEETH	DP	DE
16	25,46	24,32	30	47,75	46,60
18	28,65	27,50	32	50,93	49,79
20	31,83	30,69	36	57,30	56,15
21	33,42	32,28	40	63,66	62,52
22	35,01	33,87	44	70,03	68,89
24	38,20	37,05	48	76,39	75,25
26	41,38	40,24	60	95,49	94,35
28	44,56	43,42	72	114,59	113,45

MEGALINEAR

MTD8 OPEN-ENDED



STANDARD WIDTHS (mm)	10	15	20	30	50	85	100
Weight (gr/m)	65	85	120	185	325	530	650

Standard compound	white polyurethane thermoplastic 92 ShA
Standard back cover	none
Standard tooth cover	none
Standard cords	S and Z torsion zinked steel
Standard width tolerance	+/- 0,5 mm
Standard thickness	5,6 +/- 0,3 mm
Standard length tolerance	+/- 0,8 mm/m
Standard roll length	100 m

TOOTH PROFILE ACCORDING TO ISO 13050

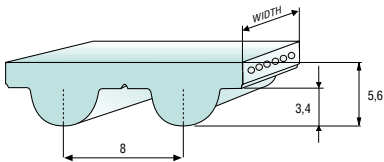

Belt options on request with minimum quantity

- Nylon fabric back**
- Nylon fabric teeth**
- Antistatic nylon fabric**
- Transparent FDA compound**
- AVAFC 60/70/85 ShA**
- APL**
- Fishbone**
- Ribbed**
- Cleats**

Different back coating materials see page 134

TOOTH RESISTANCE

RPM (1/min)	0	20	40	60	80	100	200	300	400	500	750	1000	1500	2000	3000	4000	5000	8000
F _{p spec} (N/cm)	67	66	65	64	63	63	59	57	54	52	48	45	40	37	31	28	24	18

Minimum suggested number of teeth in clamp for linear movement: 7

TRACTION RESISTANCE

CORD MATERIAL	BELT WIDTH (MM)	10	15	20	30	50	85	100
HP = Standard	Max Traction Load (N)	1425	2135	3085	4750	8075	14750	17500
	Breaking Strength (N)	5700	8550	12350	19000	32300	56050	66500
	Elongation at MTL (mm/m)	4	4	4	4	4	4	4
Kevlar	Max Traction Load (N)	785	1175	1570	2615	4450	8130	9645
	Breaking Strength (N)	3140	4710	6285	10475	17805	30900	36665
	Elongation at MTL (mm/m)	8	8	8	8	8	8	8
HF	Max Traction Load (N)	840	1365	1890	2940	5040	9170	10830
	Breaking Strength (N)	3360	5460	7560	11760	20160	34860	41160
	Elongation at MTL (mm/m)	5	5	5	5	5	5	5
Stainless	Max Traction Load (N)	1190	1785	2580	3970	6745	-	-
	Breaking Strength (N)	4765	7145	10320	15880	26995	-	-
	Elongation at MTL (mm/m)	3,8	3,8	3,8	3,8	3,8	-	-

Average values



MEGALINEAR

MTD8 OPEN-ENDED

FLEXION RESISTANCE

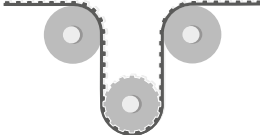
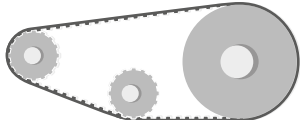
			
	Z_{MIN}	Z_{MIN} IDLER MIN DIA (MM)	Z_{MIN} IDLER MIN DIA (MM)
HP = Standard	20	22 100	20 50
Kevlar cords	20	22 100	20 50
High Flexibility cords	20	20 80	20 40
Stainless steel cords	24	28 110	24 80

JOINED BELT INFORMATION:



- Minimum splice length 900 mm
- Traction and tooth resistances = 50% less than open-ended
- Joined belt can be used only in conveyor systems
- Rolls with NFT, NFB, AVAFC and APL can be joined too
- Minimum diameters according above table
- For coated belts, minimum diameters on page 134

PULLEYS

(FOR MORE DETAILS PLEASE SEE OUR PULLEYS CATALOGUE)

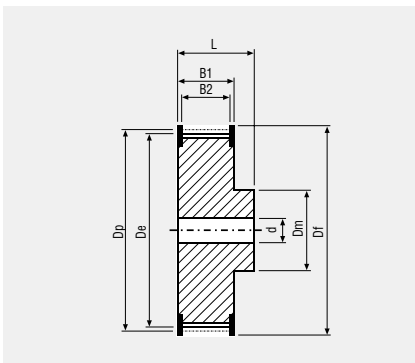

N° TEETH	DP	DE
20	50,95	49,58
22	56,02	54,65
24	61,12	59,75
26	66,21	64,84
28	71,30	70,08
30	76,39	75,13
32	81,49	80,16
34	86,58	85,22
36	91,67	90,30
38	96,77	95,39
40	101,86	100,49

N° TEETH	DP	DE
44	112,05	110,67
48	122,23	120,86
56	142,60	141,23
64	162,97	161,60
72	183,35	181,97
80	203,72	202,35
90	229,18	227,81
112	285,21	283,83
144	366,69	365,32
168	427,81	426,44
192	488,92	487,55

MEGALINEAR

MTD14 OPEN-ENDED



STANDARD WIDTHS (mm)	25	40	55	85	100	115
Weight (gr/m)	260	400	555	850	1000	1150

Standard compound	white polyurethane thermoplastic 92 ShA
Standard back cover	none
Standard tooth cover	none
Standard cords	S and Z torsion zinked steel
Standard width tolerance	+/- 1 mm
Standard thickness	10 +/- 0,45 mm
Standard length tolerance	+/- 0,8 mm/m
Standard roll length	100 m

TOOTH PROFILE ACCORDING TO ISO 13050

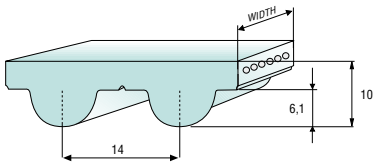

Belt options on request with minimum quantity

Nylon fabric back
Nylon fabric teeth
Antistatic nylon fabric
Transparent FDA compound
AVAFC 60/70/85 ShA
APL
Fishbone
Ribbed
Cleats

Different back coating materials see page 134

TOOTH RESISTANCE

RPM (1/min)	0	20	40	60	80	100	200	300	400	500	750	1000	1500	2000	3000	4000	5000
F _{p spec} (N/cm)	115	113	111	109	108	106	99	93	88	84	76	69	60	52	46	34	28

Minimum suggested number of teeth in clamp for linear movement: 7

TRACTION RESISTANCE

CORD MATERIAL	BELT WIDTH (MM)	25	40	55	85	100	115
		Max Traction Load (N)	5190	8650	12745	20485	24580
Steel	Breaking Strength (N)	20760	34600	48440	77850	93420	105530
	Elongation at MTL (mm/m)	4	4	4	4	4	4
	Max Traction Load (N)	5045	8410	12400	19930	23915	29330
Kevlar	Breaking Strength (N)	20195	33655	47120	75730	90875	102660
	Elongation at MTL (mm/m)	8	8	8	8	8	8

Average values



MEGALINEAR

MTD14 OPEN-ENDED

FLEXION RESISTANCE

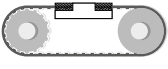
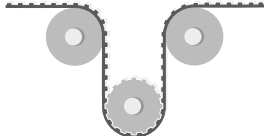
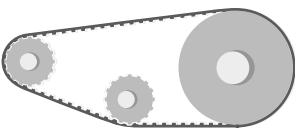
			
	Z_{MIN}	Z_{MIN} IDLER MIN DIA (MM)	Z_{MIN} IDLER MIN DIA (MM)
Standard steel cords	26	28 180	26 120
Kevlar cords	26	28 180	26 120

JOINED BELT INFORMATION:



- Minimum splice length 900 mm
- Traction and tooth resistances = 50% less than open-ended
- Joined belt can be used only in conveyor systems
- Rolls with NFT, NFB, AVAFC and APL can be joined too
- Minimum diameters according above table
- For coated belts, minimum diameters on page 134

PULLEYS

(FOR MORE DETAILS PLEASE SEE OUR PULLEYS CATALOGUE)

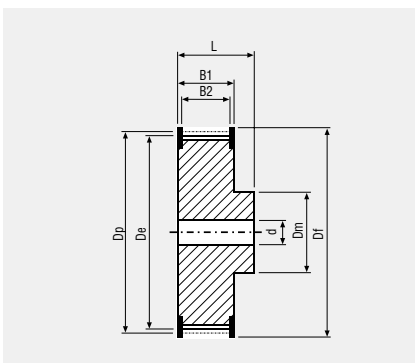

N° TEETH	DP	DE
26	115,92	113,13
28	124,78	121,98
29	129,23	126,44
30	133,69	130,90
32	142,60	139,81
34	151,51	148,72
36	160,43	157,68
38	169,34	166,60
40	178,25	175,49
44	196,08	193,28
48	213,90	211,11

N° TEETH	DP	DE
56	249,55	246,76
64	285,21	282,41
72	320,86	318,06
80	356,51	353,71
90	401,07	398,28
112	499,11	496,32
144	641,71	638,92
168	748,66	745,87
192	855,62	852,82
216	962,57	959,76

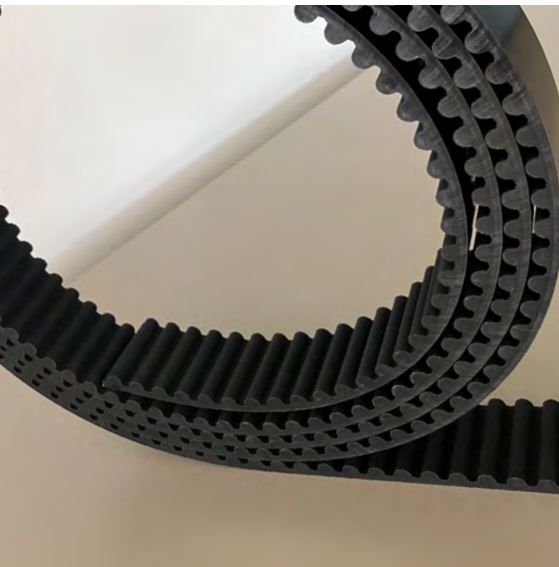

MEGALINEAR

MTD14 XHP2 OPEN-ENDED

STANDARD WIDTHS (mm)	40	55	85	115	150
Weight (gr/m)	606	881	1377	1873	2478

Standard compound	black polyurethane thermoplastic 92 ShA
Standard back cover	none
Standard tooth cover	black nylon NFT
Standard cords	S and Z torsion zinked steel
Standard width tolerance	+/- 1 mm
Standard thickness	10,2 +/- 0,5 mm
Standard length tolerance	-0,4/-1,2 mm/m
Standard roll length	100 m

TOOTH PROFILE ACCORDING TO ISO 13050

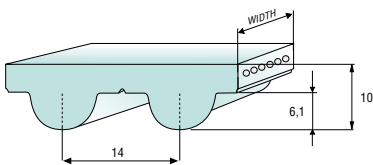

TOOTH RESISTANCE

RPM (1/min)	0	20	40	60	80	100	200	300	400	500	750	1000	1500	2000	3000	4000	5000
F _{p spec} (N/cm)	157	154	152	149	147	144	133	125	118	113	102	95	85	70	58	45	34

Minimum suggested number of teeth in clamp for linear movement: 7

TRACTION RESISTANCE

CORD MATERIAL	BELT WIDTH (MM)	40	55	85	115	150
		Max Traction Load (N)	21180	33345	52105	76935
Steel	Breaking Strength (N)	87120	126720	198000	269280	356400
	Elongation at MTL (mm/m)	4	4	4	4	4

Average values

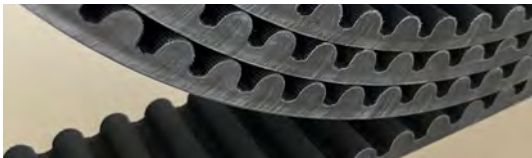

MEGALINEAR

MTD14 XHP2 OPEN-ENDED

FLEXION RESISTANCE

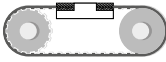
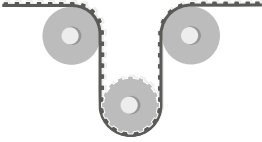
			
	Z_{MIN}	Z_{MIN}	IDLER MIN DIA (MM)
Standard steel cords	32	34	250

PULLEYS

IN CASE OF PULLEYS WITH LESS THAN 44 TEETH, THERE ARE SPECIAL REQUIREMENTS FOR PULLEYS. PLEASE CONTACT MEGADYNE STAFF FOR MORE INFORMATION.

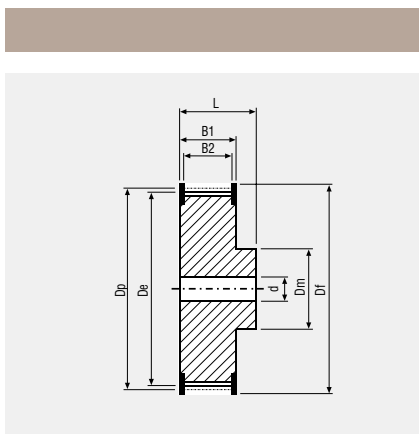

N° TEETH	DP	DE
32	142,60	139,81
34	151,52	148,73
36	160,43	157,64
38	169,34	166,55
40	178,25	175,46
44	196,08	193,29
48	213,90	211,11
56	249,55	246,76
64	285,20	282,41

N° TEETH	DP	DE
72	320,86	318,07
80	356,51	353,72
90	401,07	398,28
112	499,11	496,32
144	641,71	638,92
168	748,66	745,87
192	855,61	852,82
216	962,57	959,78

TYPICAL BELT APPLICATION



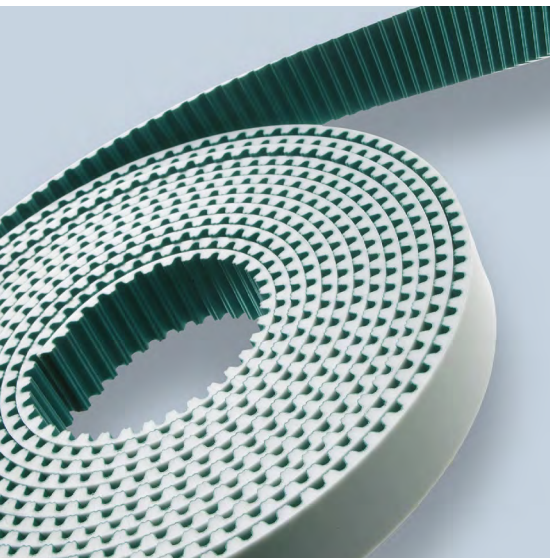

MEGALINEAR

RPP5 OPEN-ENDED

STANDARD WIDTHS (mm)	10	15	25	30	50	75
Weight (gr/m)	40	60	100	120	195	292

Standard compound	white polyurethane thermoplastic 92 ShA
Standard back cover	none
Standard tooth cover	nylon fabric (NFT)
Standard cords	S and Z torsion zinked steel
Standard width tolerance	+/- 0,5 mm
Standard thickness	3,8 +/- 0,2 mm
Standard length tolerance	+/- 0,8 mm/m
HP cord length tolerance	+0/- 0,8 mm/m
Standard roll length	100 m

Belt options on request with minimum quantity

Nylon fabric back
Antistatic nylon fabric
AVAFC 60/70/85 ShA
APL
Cleats

Different back coating materials see page 134

TOOTH PROFILE ACCORDING TO ISO 13050

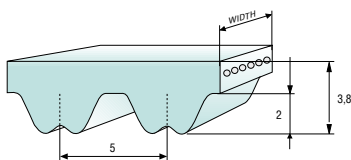

TOOTH RESISTANCE

RPM (1/min)	0	20	40	60	80	100	200	300	400	500	750	1000	1500	2000	3000	4000	5000	8000
F _{p spec} (N/cm)	37	36	36	36	35	35	33	32	30	30	27	26	24	23	21	19	18	15

Minimum suggested number of teeth in clamp for linear movement: 7 - HP cords minimum suggested number of teeth in clamp 10

TRACTION RESISTANCE

CORD MATERIAL	BELT WIDTH (MM)	10	15	25	30	50	75
		Max Traction Load (N)	670	1005	1805	2210	3750
Steel	Breaking Strength (N)	2680	4020	7235	8840	15005	23045
	Elongation at MTL (mm/m)	4	4	4	4	4	4
	Max Traction Load (N)	665	995	1795	2190	3720	-
Kevlar	Breaking Strength (N)	2660	3990	7180	8775	14895	-
	Elongation at MTL (mm/m)	8	8	8	8	8	-
	Max Traction Load (N)	590	885	1590	-	-	-
Stainless	Breaking Strength (N)	2360	3540	6370	-	-	-
	Elongation at MTL (mm/m)	3,8	3,8	3,8	-	-	-
	Max Traction Load (N)	840	1365	2415	2940	5040	8065
HP	Breaking Strength (N)	3360	5460	9660	11760	20160	30660
	Elongation at MTL (mm/m)	4	4	4	4	4	4

Average values

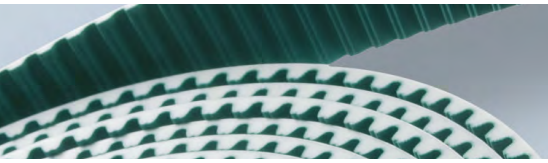

MEGALINEAR

RPP5 OPEN-ENDED

FLEXION RESISTANCE

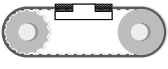
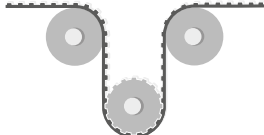
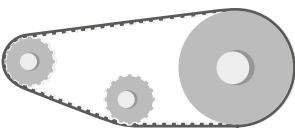
			
	Z_{MIN}	Z_{MIN} IDLER MIN DIA (MM)	Z_{MIN} IDLER MIN DIA (MM)
Standard steel cords	15	16 60	15 20
Kevlar cords	15	16 60	15 20
Stainless steel cords	18	18 65	18 65
High power cords	20	22 60	20 40

JOINED BELT INFORMATION:

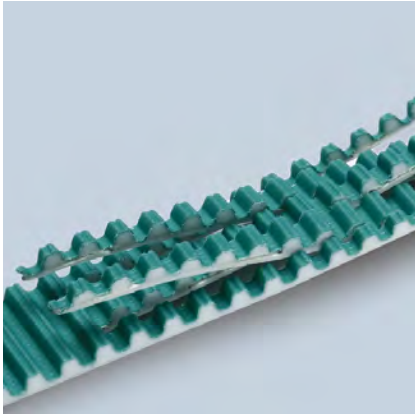

- Minimum splice length 900 mm
- Traction and tooth resistances = 50% less than open-ended
- Joined belt can be used only in conveyor systems
- Rolls with NFT, NFB, AVAFC and APL can be joined too
- Minimum diameters according above table
- For coated belts, minimum diameters on page 134

PULLEYS

(FOR MORE DETAILS PLEASE SEE OUR PULLEYS CATALOGUE)

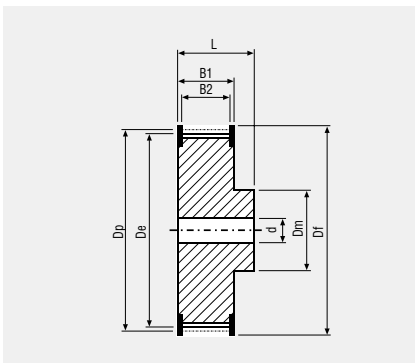

N° TEETH	DP	DE
15	23,87	22,73
16	25,46	24,32
18	28,65	27,50
20	31,83	30,69
21	33,42	32,28
22	35,01	33,87
24	38,20	37,05
26	41,38	40,24
28	44,56	43,42

N° TEETH	DP	DE
30	47,75	46,60
32	50,93	49,79
36	57,30	56,15
40	63,66	62,52
44	70,03	68,89
48	76,39	75,25
60	95,49	94,35
72	114,59	113,45

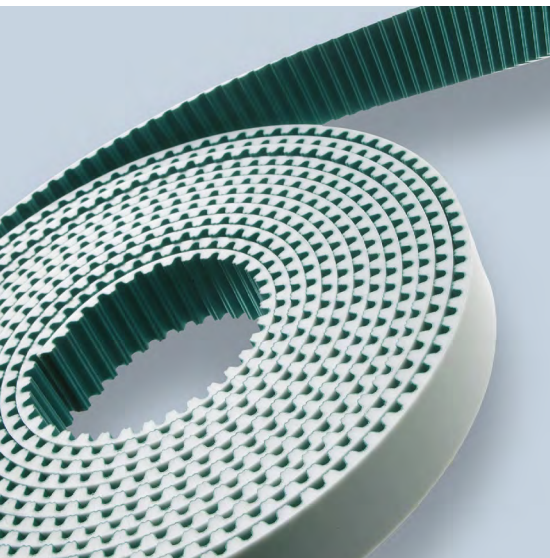

MEGALINEAR

RPP8 OPEN-ENDED

STANDARD WIDTHS (mm)	10	15	20	30	50	85	100
Weight (gr/m)	65	100	130	195	330	560	655

Standard compound	white polyurethane thermoplastic 92 ShA
Standard back cover	none
Standard tooth cover	nylon fabric (NFT)
Standard cords	S and Z torsion zinked steel
Standard width tolerance	+/- 0,5 mm
Standard thickness	5,4 +/- 0,3 mm
Standard length tolerance	+/- 0,8 mm/m
HP cord length tolerance	+0/- 0,8 mm/m
Standard roll length	100 m

TOOTH PROFILE ACCORDING TO ISO 13050

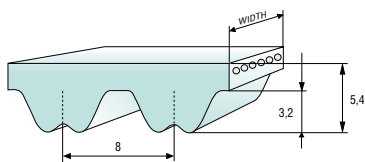

Belt options on request with minimum quantity

Nylon fabric back
Antistatic nylon fabric
AVAFC 60/70/85 ShA
APL
Fishbone
Ribbed
Cleats

Different back coating materials see page 134

TOOTH RESISTANCE

RPM (1/min)	0	20	40	60	80	100	200	300	400	500	750	1000	1500	2000	3000	4000	5000	8000
F _{p spec} (N/cm)	76	75	74	73	72	71	65	62	60	57	53	50	45	42	38	35	32	25

Minimum suggested number of teeth in clamp for linear movement: 7 - HP cords minimum suggested number of teeth in clamp 10

TRACTION RESISTANCE

CORD MATERIAL	BELT WIDTH (MM)	10	15	20	30	50	85	100
		Max Traction Load (N)	1425	2135	3085	4750	8075	14750
Steel	Breaking Strength (N)	5700	8550	12350	19000	32300	56050	66500
	Elongation at MTL (mm/m)	4	4	4	4	4	4	4
	Max Traction Load (N)	1185	1780	2570	3955	6725	12285	14580
Kevlar	Breaking Strength (N)	4745	7120	10285	15830	26910	46695	55405
	Elongation at MTL (mm/m)	8	8	8	8	8	8	8
	Max Traction Load (N)	2160	3460	4755	7785	12975	24125	27770
HP	Breaking Strength (N)	8650	13840	19030	31140	51900	91690	105530
	Elongation at MTL (mm/m)	4	4	4	4	4	4	4

Average values

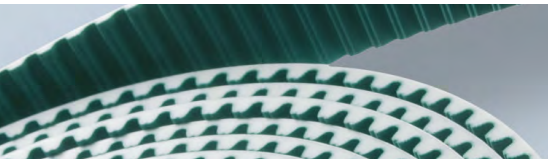

MEGALINEAR

RPP8 OPEN-ENDED

FLEXION RESISTANCE

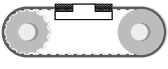
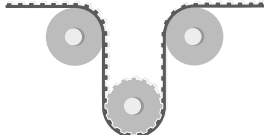
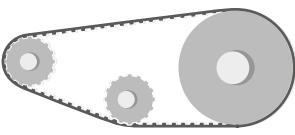
			
	Z_{MIN}	Z_{MIN} IDLER MIN DIA (MM)	Z_{MIN} IDLER MIN DIA (MM)
Standard steel cords	18	20 100	18 45
Kevlar cords	18	20 100	18 45
High power cords	30	34 180	30 60

JOINED BELT INFORMATION:

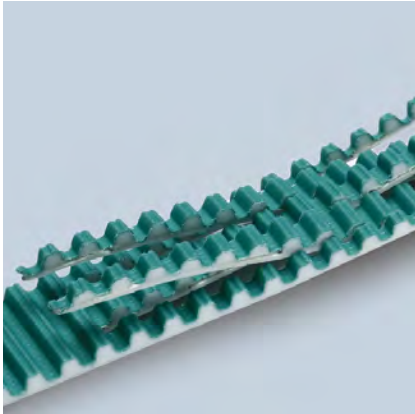

- Minimum splice length 900 mm
- Traction and tooth resistances = 50% less than open-ended
- Joined belt can be used only in conveyor systems
- Rolls with NFT, NFB, AVAFC and APL can be joined too
- Minimum diameters according above table
- For coated belts, minimum diameters on page 134

PULLEYS

IN CASE OF PULLEYS WITH LESS THAN 44 TEETH, THERE ARE SPECIAL REQUIREMENTS FOR PULLEYS. PLEASE CONTACT MEGADYNE STAFF FOR MORE INFORMATION.

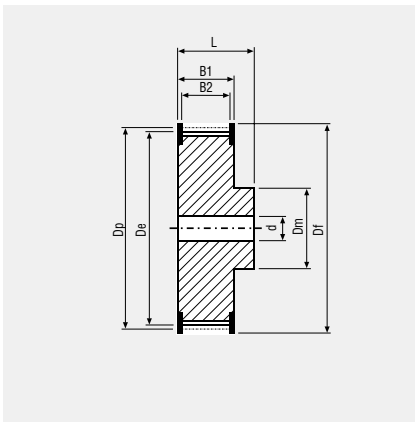

N° TEETH	DP	DE
18	45,86	44,49
22	56,02	54,65
24	61,12	59,74
26	66,21	64,84
28	71,30	69,93
30	76,39	75,02
32	81,49	80,12
34	86,58	85,21
36	91,67	90,30
38	96,77	95,39
40	101,86	100,49

N° TEETH	DP	DE
44	112,04	110,67
48	122,23	120,86
54	137,51	136,14
64	162,97	161,60
72	183,35	181,97
80	203,72	202,35
90	229,18	227,81
112	285,20	283,83
144	366,69	365,32
168	427,81	426,44
192	488,92	487,55

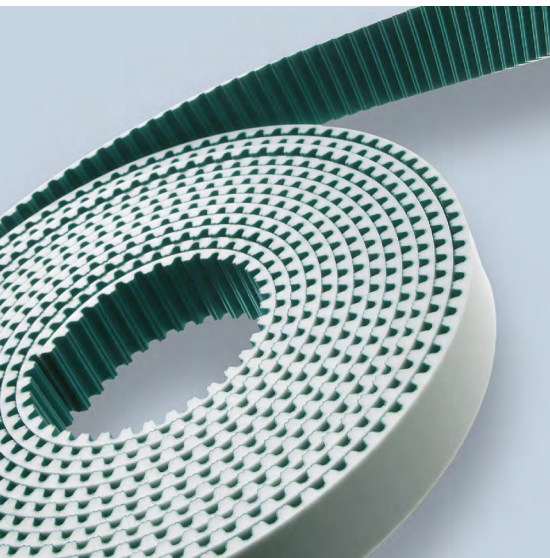

MEGALINEAR

RPP14 OPEN-ENDED

STANDARD WIDTHS (mm)	40	55	85	115	150
Weight (gr/m)	635	924	1443	1963	2598

Standard compound	white polyurethane thermoplastic 92 ShA
Standard back cover	none
Standard tooth cover	nylon fabric (NFT)
Standard cords	S and Z torsion zinked steel
Standard width tolerance	+/- 1 mm
Standard thickness	10 +/- 0,4 mm
Standard length tolerance	+/- 0,8 mm/m
HP cord length tolerance	+0/- 0,8 mm/m
Standard roll length	100 m

Belt options on request with minimum quantity

- Nylon fabric back**
- Antistatic nylon fabric**
- AVAFC 60/70/85 ShA**
- APL**
- Fishbone**
- Ribbed**
- Cleats**

TOOTH PROFILE ACCORDING TO ISO 13050

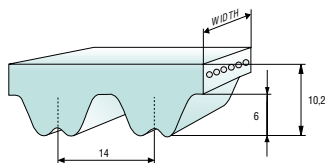

Different back coating materials see page 134

TOOTH RESISTANCE

RPM (1/min)	0	20	40	60	80	100	200	300	400	500	750	1000	1500	2000	3000	4000	5000
F _{p spec} (N/cm)	140	137	135	133	131	128	118	111	105	101	91	84	75	62	52	40	30

Minimum suggested number of teeth in clamp for linear movement: 12

TRACTION RESISTANCE

CORD MATERIAL	BELT WIDTH (MM)	40	55	85	115	150
		Steel	Max Traction Load (N)	15200	22000	35000
	Breaking Strength (N)	60800	83600	133000	178600	235600
	Elongation at MTL (mm/m)	4	4	4	4	4

Average values

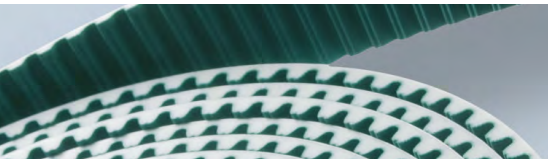

MEGALINEAR

RPP14 OPEN-ENDED

FLEXION RESISTANCE

	Z _{MIN}	Z _{MIN} IDLER MIN DIA (MM)	Z _{MIN} IDLER MIN DIA (MM)
Standard steel cords	32	34 250	32 145

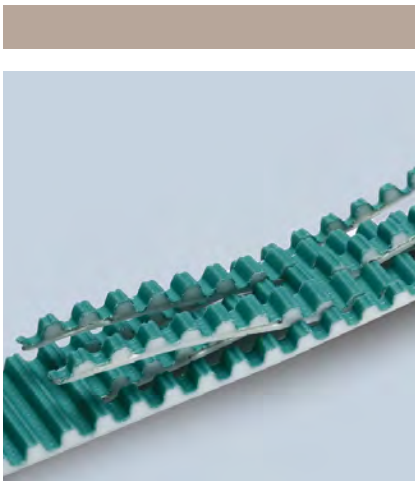

JOINED BELT INFORMATION:

- Minimum splice length 900 mm
- Traction and tooth resistances = 50% less than open-ended
- Joined belt can be used only in conveyor systems
- Rolls with NFT, NFB, AVAFC and APL can be joined too
- Minimum diameters according above table
- For coated belts, minimum diameters on page 134

PULLEYS

(FOR MORE DETAILS PLEASE SEE OUR PULLEYS CATALOGUE)

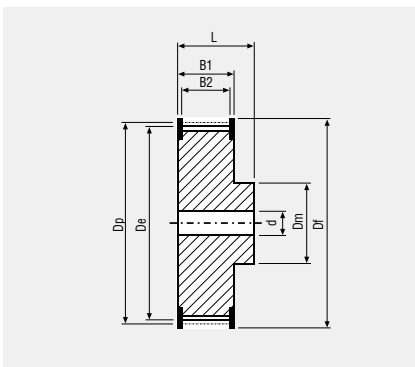

N° TEETH	DP	DE
32	142,60	139,81
34	151,52	148,73
36	160,43	157,64
38	169,34	166,55
40	178,25	175,46
44	196,08	193,29
48	213,90	211,11
56	249,55	246,76
64	285,20	282,41

N° TEETH	DP	DE
72	320,86	318,07
80	356,51	353,72
90	401,07	398,28
112	499,11	496,32
144	641,71	638,92
168	748,66	745,87
192	855,61	852,82
216	962,57	959,78

MEGALINEAR

RPP14 XHP2 OPEN-ENDED

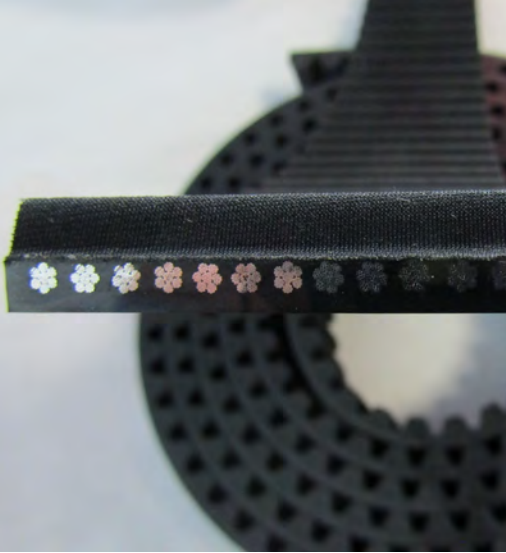

STANDARD WIDTHS (mm)	40	55	85	115	150
Weight (gr/m)	635	924	1443	1963	2598

Standard compound	black polyurethane thermoplastic 92 ShA
Standard back cover	none
Standard tooth cover	black nylon NFT
Standard cords	S and Z torsion zinked steel
Standard width tolerance	+/- 1 mm
Standard thickness	10,2 +/- 0,5 mm
Standard length tolerance	-0,4/-1,2 mm/m
Standard roll length	100 m

TOOTH PROFILE ACCORDING TO ISO 13050

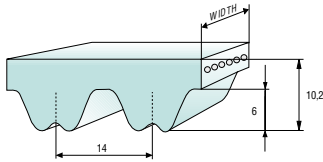

TOOTH RESISTANCE

RPM (1/min)	0	20	40	60	80	100	200	300	400	500	750	1000	1500	2000	3000	4000	5000
F _{p spec} (N/cm)	154	151	149	146	144	141	130	122	116	111	100	93	83	68	57	44	33

Minimum suggested number of teeth in clamp for linear movement: 12

TRACTION RESISTANCE

CORD MATERIAL	BELT WIDTH (MM)	40	55	85	115	150
		Max Traction Load (N)	21180	33345	52105	76935
Steel	Breaking Strength (N)	87120	126720	198000	269280	356400
	Elongation at MTL (mm/m)	4	4	4	4	4

Average values



MEGALINEAR

RPP14 XHP2 OPEN-ENDED

FLEXION RESISTANCE

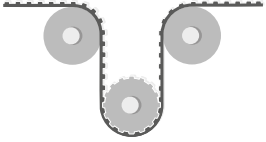
		
	Z_{MIN}	Z_{MIN} IDLER MIN DIA (MM)
Standard steel cords	32	34 250

PULLEYS

IN CASE OF PULLEYS WITH LESS THAN 44 TEETH, THERE ARE SPECIAL REQUIREMENTS FOR PULLEYS. PLEASE CONTACT MEGADYNE STAFF FOR MORE INFORMATION.

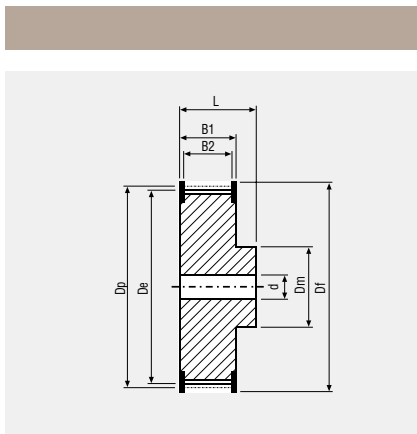

N° TEETH	DP	DE
32	142,60	139,81
34	151,52	148,73
36	160,43	157,64
38	169,34	166,55
40	178,25	175,46
44	196,08	193,29
48	213,90	211,11
56	249,55	246,76
64	285,20	282,41

N° TEETH	DP	DE
72	320,86	318,07
80	356,51	353,72
90	401,07	398,28
112	499,11	496,32
144	641,71	638,92
168	748,66	745,87
192	855,61	852,82
216	962,57	959,78

TYPICAL BELT APPLICATION



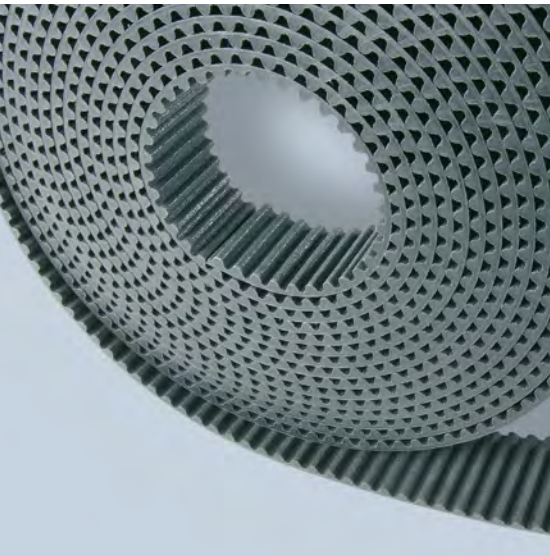

MEGALINEAR

STD5 OPEN-ENDED

STANDARD WIDTHS (mm)	10	15	25	50	75	100	150
Weight (gr/m)	35	50	80	165	245	330	495

Standard compound	black polyurethane thermoplastic 92 ShA
Standard back cover	none
Standard tooth cover	antistatic nylon fabric (NFT)
Standard cords	S and Z torsion zinked steel
Standard width tolerance	+/- 0,5 mm
Standard thickness	3,4 +/- 0,25 mm
Standard length tolerance	+/- 0,8 mm/m
Standard roll length	100 m
Belt options on request with minimum quantity	Nylon fabric back AVAFC 60/70/85 ShA APL Cleats

Different back coating materials see page 134

TOOTH PROFILE ACCORDING TO ISO 13050

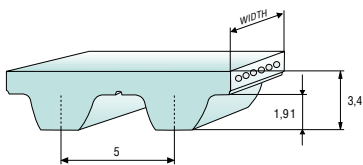

TOOTH RESISTANCE

RPM (1/min)	0	20	40	60	80	100	200	300	400	500	750	1000	1500	2000	3000	4000	5000	8000
F _{p spec} (N/cm)	34	34	33	32	31	30	29	27	25	24	22	20	17	15	12	10	8	3

Minimum suggested number of teeth in clamp for linear movement: 7

TRACTION RESISTANCE

CORD MATERIAL	BELT WIDTH (MM)	10	15	25	50	75	100	150
Steel	Max Traction Load (N)	670	1005	1805	3750	6065	6910	7810
	Breaking Strength (N)	2680	4020	7235	15005	23045	26260	27335
	Elongation at MTL (mm/m)	4	4	4	4	4	4	4

Average values



MEGALINEAR

STD5 OPEN-ENDED

FLEXION RESISTANCE

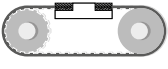
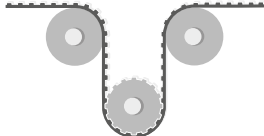
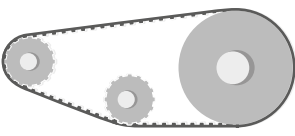
			
	Z_{MIN}	Z_{MIN} IDLER MIN DIA (MM)	Z_{MIN} IDLER MIN DIA (MM)
Standard steel cords	12	13 60	12 20

JOINED BELT INFORMATION:

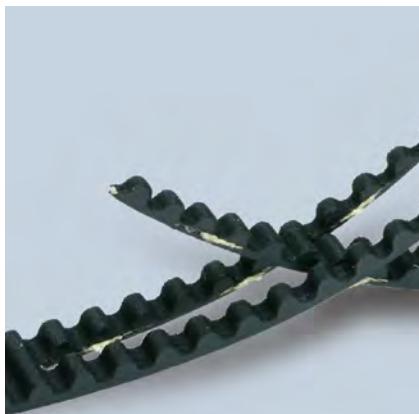

- Minimum splice length 900 mm
- Traction and tooth resistances = 50% less than open-ended
- Joined belt can be used only in conveyor systems
- Rolls with NFT, NFB, AVAFC and APL can be joined too
- Minimum diameters according above table
- For coated belts, minimum diameters on page 134

PULLEYS

(FOR MORE DETAILS PLEASE SEE OUR PULLEYS CATALOGUE)

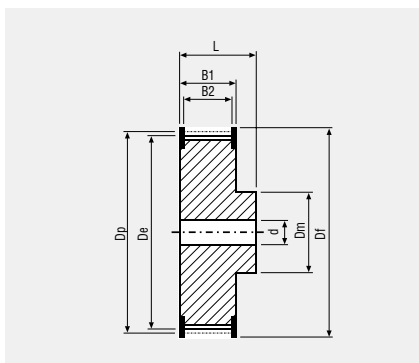

N° TEETH	DP	DE	N° TEETH	DP	DE
12	19,10	18,14	28	44,58	43,60
14	22,29	21,32	30	47,77	46,79
15	23,88	22,91	32	50,95	49,79
16	25,47	24,50	36	57,32	56,34
18	28,66	27,69	40	63,69	62,70
20	31,84	30,87	44	70,06	69,07
22	35,03	34,05	48	76,43	75,43
24	38,21	37,24	60	95,54	94,53
26	41,40	40,42	72	114,64	113,63

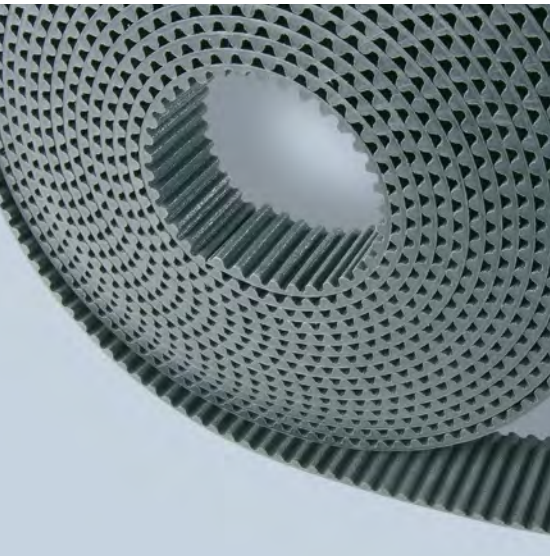

MEGALINEAR

STD8 OPEN-ENDED

STANDARD WIDTHS (mm)	10	12	15	20	30	50	85
Weight (gr/m)	65	75	85	120	185	325	530

Standard compound	black polyurethane
thermoplastic	92 ShA
Standard back cover	none
Standard tooth cover	antistatic nylon fabric (NFT)
Standard cords	S and Z torsion zinked steel
Standard width tolerance	+/- 0,5 mm
Standard thickness	5,1 +/- 0,25 mm
Standard length tolerance	+/- 0,8 mm/m
Standard roll length	100 m

Belt options on request with minimum quantity

- Nylon fabric back**
- AVAFc 60/70/85 ShA**
- APL**
- Fishbone**
- Ribbed**
- Cleats**

TOOTH PROFILE ACCORDING TO ISO 13050

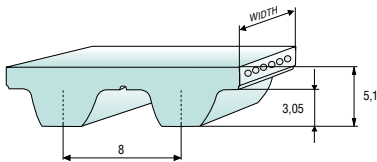

Different back coating materials see page 134

TOOTH RESISTANCE

RPM (1/min)	0	20	40	60	80	100	200	300	400	500	750	1000	1500	2000	3000	4000	5000
F _{p spec} (N/cm)	64	62	58	56	54	51	48	46	44	42	38	35	31	27	23	20	17

Minimum suggested number of teeth in clamp for linear movement: 7

TRACTION RESISTANCE

CORD MATERIAL	BELT WIDTH (MM)	10	12	15	20	30	50	85
		HP = Standard						
	Max Traction Load (N)	1425	1660	2135	3085	4750	8075	14750
	Breaking Strength (N)	5700	6650	8550	12350	19000	32300	56050
	Elongation at MTL (mm/m)	4	4	4	4	4	4	4
Kevlar								
	Max Traction Load (N)	1185	1385	1780	2570	3955	6725	12285
	Breaking Strength (N)	4745	5540	7120	10285	15830	26910	46695
	Elongation at MTL (mm/m)	8	8	8	8	8	8	8
HF								
	Max Traction Load (N)	840	1050	1365	1890	2940	5040	9170
	Breaking Strength (N)	3360	4200	5460	7560	11760	20160	34860
	Elongation at MTL (mm/m)	5	5	5	5	5	5	5

Average values



MEGALINEAR

STD8 OPEN-ENDED

FLEXION RESISTANCE

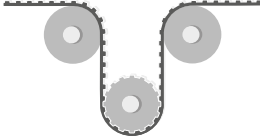
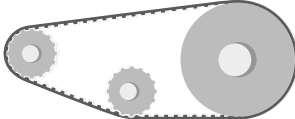
			
	Z_{MIN}	Z_{MIN} IDLER MIN DIA (MM)	Z_{MIN} IDLER MIN DIA (MM)
HP = standard	20	24 100	20 50
Kevlar cords	20	24 100	20 50
High Flexibility cords	16	24 60	22 40

JOINED BELT INFORMATION:

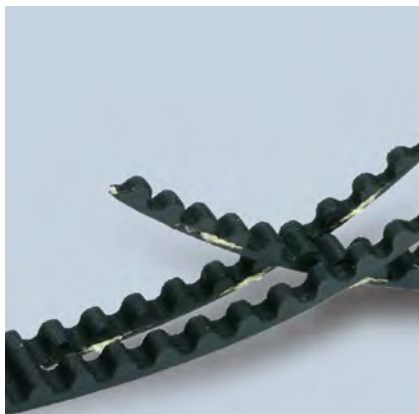

- Minimum splice length 900 mm
- Traction and tooth resistances = 50% less than open-ended
- Joined belt can be used only in conveyor systems
- Rolls with NFT, NFB, AVAFC and APL can be joined too
- Minimum diameters according above table
- For coated belts, minimum diameters on page 134

PULLEYS

(FOR MORE DETAILS PLEASE SEE OUR PULLEYS CATALOGUE)

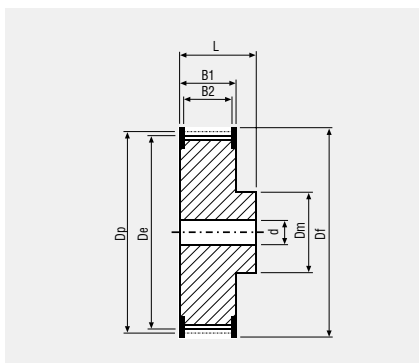

N° TEETH	DP	DE
22	56,05	54,65
24	61,14	59,75
26	66,24	64,84
28	71,33	69,93
30	76,43	75,02
32	81,52	80,12
34	86,62	85,21
36	91,71	90,30
38	96,81	95,40
40	101,91	100,49
44	112,10	110,68

N° TEETH	DP	DE
48	122,29	120,86
56	142,67	141,23
64	163,05	161,60
72	183,43	181,98
80	203,82	202,35
90	229,29	227,81
112	285,35	283,84
144	366,87	365,32
168	428,02	426,44
192	489,17	487,55

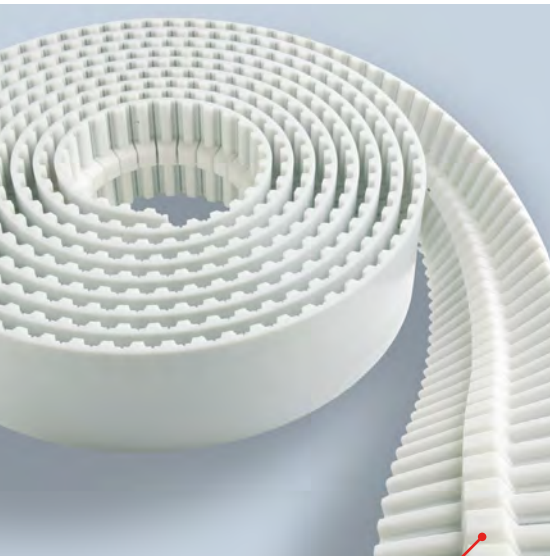

MEGALINEAR

HG OPEN-ENDED

STANDARD WIDTHS (inch)	150	200	300	400	600
STANDARD WIDTHS (mm)	38,1	50,8	76,2	101,6	152,4
Weight (gr/m)	230	285	395	500	800

Standard compound	white polyurethane thermoplastic 92 ShA
Standard back cover	none
Standard tooth cover	none
Standard cords	S and Z torsion zinked steel
Standard width tolerance	+/- 0,5 mm
Standard length tolerance	+/- 0,8 mm/m
Standard roll length	100 m

Belt options on request with minimum quantity	Nylon fabric back Nylon fabric teeth* Antistatic nylon fabric Transparent FDA compound Cleats
---	--

NOTCHED GUIDE

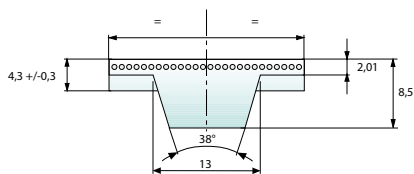

Different back coating materials see page 134

* Nylon fabric teeth including guide (fabric on complete width) is standard version.
 Nylon fabric teeth excluding guide (2 fabric strips on teeth only) is only on request.

TOOTH RESISTANCE

RPM (1/min)	0	20	40	60	80	100	200	300	400	500	750	1000	1500	2000	3000	4000	5000	8000
F _{p spec} (N/cm)	44	43	42	41	40	39	36	34	33	31	29	27	24	22	19	17	16	12

Minimum suggested number of teeth in clamp for linear movement: 7

TRACTION RESISTANCE

CORD MATERIAL	BELT WIDTH (MM)	150	200	300	400	600
		Max Traction Load (N)	3675	5040	8065	11760
Steel	Breaking Strength (N)	14700	20160	30660	41160	40320
	Elongation at MTL (mm/m)	4	4	4	4	4
	Max Traction Load (N)	3270	4685	7165	10475	14360
Kevlar	Breaking Strength (N)	13095	17805	27235	36665	50270
	Elongation at MTL (mm/m)	8	8	8	8	8

Average values



MEGALINEAR

HG OPEN-ENDED

FLEXION RESISTANCE

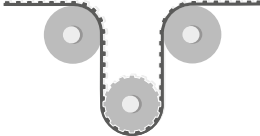
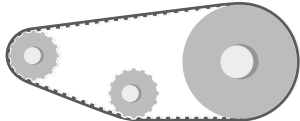
			
	Z _{MIN}	Z _{MIN} IDLER MIN DIA (MM)	Z _{MIN} IDLER MIN DIA (MM)
Standard steel cords	20	22 160	20 80
Kevlar cords	20	22 160	20 80

JOINED BELT INFORMATION:



- Minimum splice length 900 mm
- Traction and tooth resistances = 50% less than open-ended
- Joined belt can be used only in conveyor systems
- Rolls with NFT and NFB can be joined too
- Minimum diameters according above table
- For coated belts, minimum diameters on page 134

PULLEYS

(FOR MORE DETAILS PLEASE SEE OUR PULLEYS CATALOGUE)

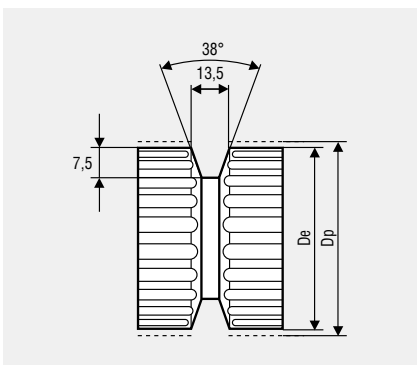

N° TEETH	DP	DE	N° TEETH	DP	DE
20	80,85	79,48	34	137,45	136,08
22	88,94	87,57	36	145,53	144,16
24	97,02	95,65	38	153,62	152,25
26	105,11	103,74	40	161,70	160,33
28	113,19	111,82	44	177,87	176,50
30	121,28	119,91	48	194,04	192,67
32	129,36	127,99	60	242,55	241,18

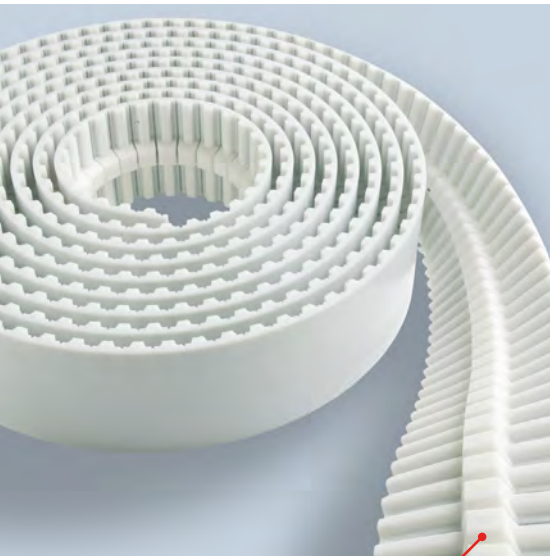

MEGALINEAR

TG5 OPEN-ENDED

STANDARD WIDTHS (mm)	25	32	50
Weight (gr/m)	70	85	120

Standard compound	white polyurethane thermoplastic 92 ShA
Standard back cover	none
Standard tooth cover	none
Standard cords	S and Z torsion zinked steel
Standard width tolerance	+/- 0,5 mm
Standard length tolerance	+/- 0,8 mm/m
Standard roll length	100 m
Belt options on request with minimum quantity	Nylon fabric back Nylon fabric teeth* Antistatic nylon fabric Transparent FDA compound Cleats

NOTCHED GUIDE

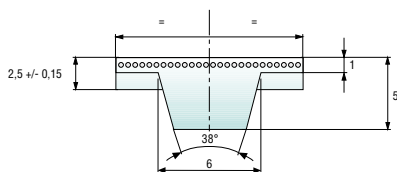

Different back coating materials see page 134

* Nylon fabric teeth excluding guide (2 fabric strips on teeth only)

TOOTH RESISTANCE

RPM (1/min)	0	20	40	60	80	100	200	300	400	500	750	1000	1500	2000	3000	4000	5000	8000
F _{p spec} (N/cm)	24	23	23	22	22	22	20	19	19	18	17	16	15	14	12	11	11	9

Minimum suggested number of teeth in clamp for linear movement: 7

TRACTION RESISTANCE

CORD MATERIAL	BELT WIDTH (MM)	25	32	50
		Max Traction Load (N)	840	1060
Steel	Breaking Strength (N)	3375	4250	7000
	Elongation at MTL (mm/m)	4	4	4
	Max Traction Load (N)	2225	2800	4615
Kevlar	Breaking Strength (N)	8900	11210	18465
	Elongation at MTL (mm/m)	8	8	8

Average values



MEGALINEAR

TG5 OPEN-ENDED

FLEXION RESISTANCE

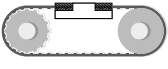
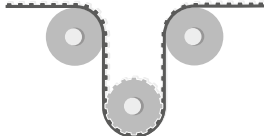
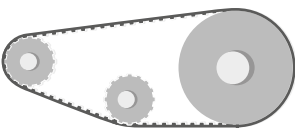
			
	Z_{MIN}	Z_{MIN} IDLER MIN DIA (MM)	Z_{MIN} IDLER MIN DIA (MM)
Standard steel cords	25	28 80	25 60
Kevlar cords	25	28 80	25 60

JOINED BELT INFORMATION:



- Minimum splice length 900 mm
- Traction and tooth resistances = 50% less than open-ended
- Joined belt can be used only in conveyor systems
- Rolls with NFT and NFB can be joined too
- Minimum diameters according above table
- For coated belts, minimum diameters on page 134

PULLEYS

(FOR MORE DETAILS PLEASE SEE OUR PULLEYS CATALOGUE)

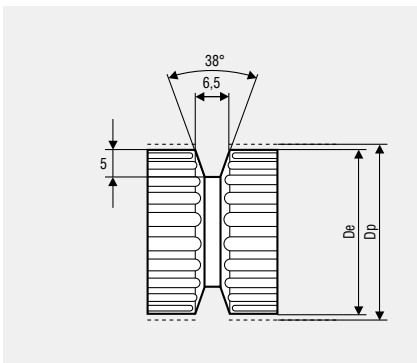

N° TEETH	DP	DE
25	39,79	38,96
27	42,97	42,14
30	47,75	46,92
32	50,93	50,1
36	57,3	56,47
40	63,66	62,93
48	76,39	75,57
60	95,49	94,67

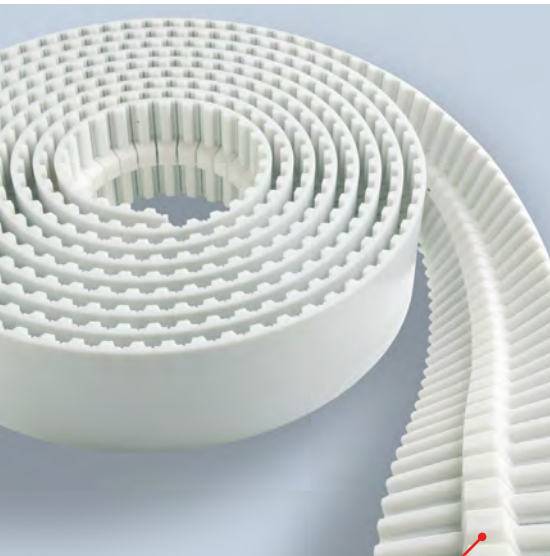

MEGALINEAR

TG10 OPEN-ENDED

STANDARD WIDTHS (mm)	25TG10K13	32TG10K13	50TG10K13	75TG10K13	100TG10K13	50TG10K6
Weight (gr/m)	190	250	290	390	495	240

Standard compound	white polyurethane thermoplastic 92 ShA
Standard back cover	none
Standard tooth cover	none
Standard cords	S and Z torsion zinked steel
Standard width tolerance	+/- 0,5 mm
Standard length tolerance	+/- 0,8 mm/m
Standard roll length	100 m

Nylon fabric back
Nylon fabric teeth*
Antistatic nylon fabric
Transparent FDA compound
AVAFC 60/70/85 ShA
Cleats

Belt options on request with minimum quantity

Different back coating materials see page 134

**K13 - Nylon fabric teeth excluding guide (2 fabric strips on teeth only) is standard version.*

Nylon fabric teeth including guide (fabric on complete width) is only on request.

K6 - Nylon fabric teeth including guide (fabric on complete width) is standard version.

Nylon fabric teeth excluding guide (2 fabric strips on teeth only) is only on request.

NOTCHED GUIDE

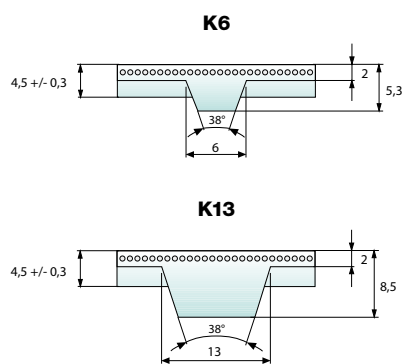

TOOTH RESISTANCE

RPM (1/min)	0	20	40	60	80	100	200	300	400	500	750	1000	1500	2000	3000	4000	5000	8000
F _{p spec} (N/cm)	51	49	48	47	46	45	41	39	37	36	33	31	28	25	22	20	18	14

Minimum suggested number of teeth in clamp for linear movement: 7

TRACTION RESISTANCE

CORD MATERIAL	BELT WIDTH (MM)	25TG10K13	32TG10K13	50TG10K13	75TG10K13	100TG10K13	50TG10K6
Steel	Max Traction Load (N)	2415	3045	5040	8065	10830	5040
	Breaking Strength (N)	9660	12180	20160	30660	41160	20160
	Elongation at MTL (mm/m)	4	4	4	4	4	4
Kevlar	Max Traction Load (N)	2095	2615	4450	7165	9645	4450
	Breaking Strength (N)	8380	10475	17805	27235	36665	17805
	Elongation at MTL (mm/m)	8	8	8	8	8	8
Stainless	Max Traction Load (N)	2190	2760	4570	-	-	4570
	Breaking Strength (N)	8760	11045	18285	-	-	18285
	Elongation at MTL (mm/m)	3,8	3,8	3,8	-	-	3,8

Average values



MEGALINEAR

TG10 OPEN-ENDED

FLEXION RESISTANCE

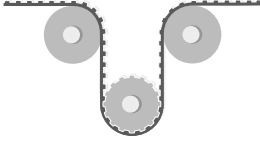
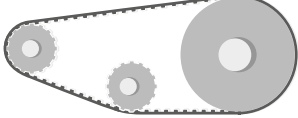
			
	Z_{MIN}	Z_{MIN} IDLER MIN DIA (MM)	Z_{MIN} IDLER MIN DIA (MM)
Standard steel cords	25	28 80	25 80
Kevlar cords	25	28 80	25 80
Stainless steel cords	31	34 90	31 90

JOINED BELT INFORMATION:



- Minimum splice length 900 mm
- Traction and tooth resistances = 50% less than open-ended
- Joined belt can be used only in conveyor systems
- Rolls with NFT, NFB, and AVAFC can be joined too
- Minimum diameters according above table
- For coated belts, minimum diameters on page 134

PULLEYS

(FOR MORE DETAILS PLEASE SEE OUR PULLEYS CATALOGUE)

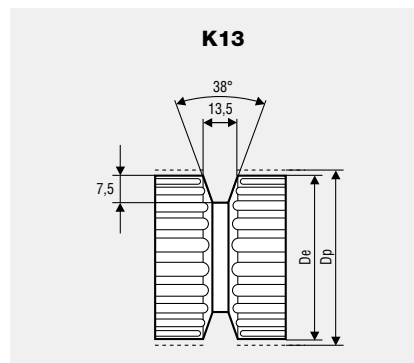
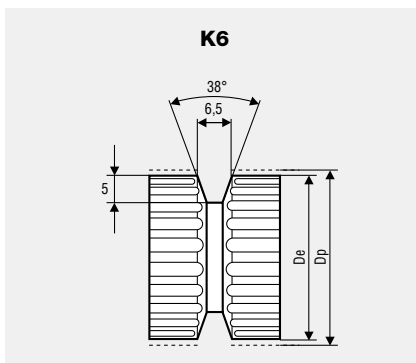

N° TEETH	Dp	De
25	79,58	77,73
27	85,94	84,10
30	95,49	93,65
32	101,86	100,01
36	114,59	112,74
40	127,32	125,48
48	152,79	150,94
60	190,99	189,14

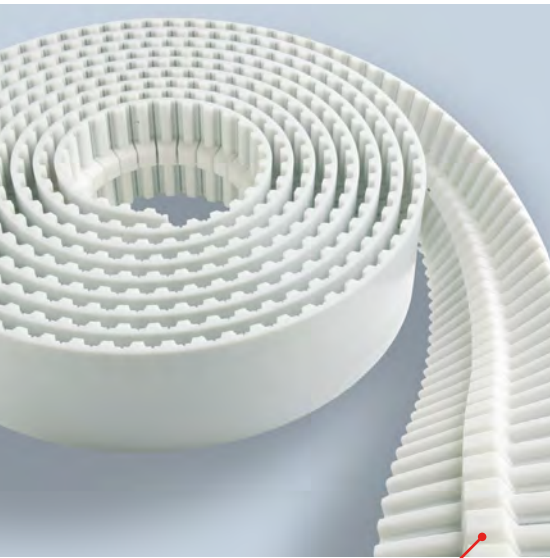

MEGALINEAR

TG20 OPEN-ENDED

STANDARD WIDTHS (mm)	50	75	100
Weight (gr/m)	375	590	770

Standard compound	white polyurethane thermoplastic 92 ShA
Standard back cover	none
Standard tooth cover	none
Standard cords	S and Z torsion zinked steel
Standard width tolerance	+/- 1 mm
Standard length tolerance	+/- 0,8 mm/m
Standard roll length	100 m

NOTCHED GUIDE

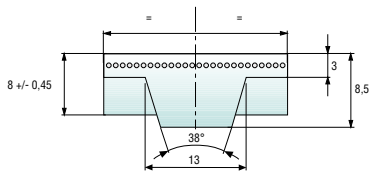

Belt options on request with minimum quantity	Nylon fabric back Nylon fabric teeth* Antistatic nylon fabric Transparent FDA compound Cleats
---	--

Different back coating materials see page 134

**Nylon fabric teeth including guide (fabric on complete width) is standard version.
Nylon fabric teeth excluding guide (2 fabric strips on teeth only) is only on request.*

TOOTH RESISTANCE

RPM (1/min)	0	20	40	60	80	100	200	300	400	500	750	1000	1500	2000	3000	4000	5000
F _{p spec} (N/cm)	102	98	95	93	91	89	81	76	72	68	62	57	50	45	38	33	29

Minimum suggested number of teeth in clamp for linear movement: 7

TRACTION RESISTANCE

CORD MATERIAL	BELT WIDTH (MM)	50	75	100
		Max Traction Load (N)	8075	13000
Steel	Breaking Strength (N)	32300	49400	66500
	Elongation at MTL (mm/m)	4	4	4
	Max Traction Load (N)	10935	17715	23915
Kevlar	Breaking Strength (N)	43755	67315	90875
	Elongation at MTL (mm/m)	8	8	8

Average values



MEGALINEAR

TG20 OPEN-ENDED

FLEXION RESISTANCE

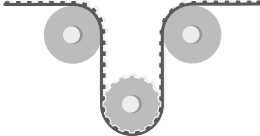
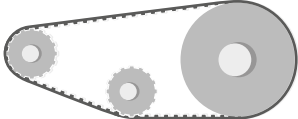
			
	Z_{MIN}	Z_{MIN} IDLER MIN DIA (MM)	Z_{MIN} IDLER MIN DIA (MM)
Standard steel cords	30	33 140	30 120
Kevlar cords	30	33 140	30 120

JOINED BELT INFORMATION:



- Minimum splice length 900 mm
- Traction and tooth resistances = 50% less than open-ended
- Joined belt can be used only in conveyor systems
- Rolls with NFT and NFB can be joined too
- Minimum diameters according above table
- For coated belts, minimum diameters on page 134

PULLEYS

(FOR MORE DETAILS PLEASE SEE OUR PULLEYS CATALOGUE)

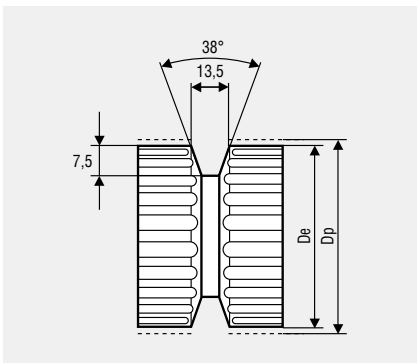

N° TEETH	DP	DE
30	190,99	188,13
32	203,72	200,86
36	229,18	226,33
40	254,65	251,80
48	305,58	302,73
60	381,97	379,12

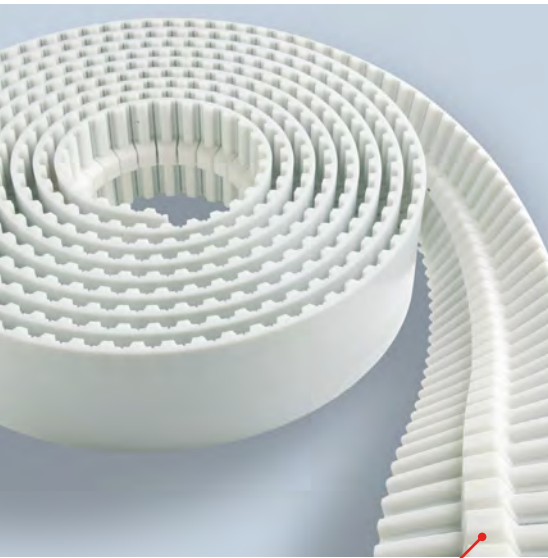

MEGALINEAR

ATG5 OPEN-ENDED

STANDARD WIDTHS (mm)	25	32	50
Weight (gr/m)	95	120	180

Standard compound	white polyurethane thermoplastic 92 ShA
Standard back cover	none
Standard tooth cover	none
Standard cords	S and Z torsion zinked steel
Standard width tolerance	+/- 1 mm
Standard length tolerance	+/- 0,8 mm/m
Standard roll length	100 m

NOTCHED GUIDE

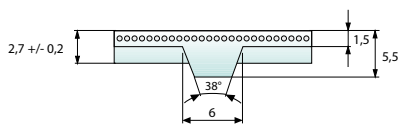

Belt options on request with minimum quantity

Nylon fabric back
Nylon fabric teeth*
Antistatic nylon fabric
Transparent FDA compound
AVAFC 60/70/85 ShA
Cleats

Different back coating materials see page 134

**Nylon fabric teeth excluding guide (2 fabric strips on teeth only).*

TOOTH RESISTANCE

RPM (1/min)	0	20	40	60	80	100	200	300	400	500	750	1000	1500	2000	3000	4000	5000	8000
F _{p spec} (N/cm)	35	35	35	34	34	34	32	31	30	29	27	26	24	22	19	18	16	13

Minimum suggested number of teeth in clamp for linear movement: 7

TRACTION RESISTANCE

CORD MATERIAL	BELT WIDTH (MM)	25	32	50
Steel	Max Traction Load (N)	1805	2275	3750
	Breaking Strength (N)	7235	9110	15005
	Elongation at MTL (mm/m)	4	4	4

Average values



MEGALINEAR

ATG5 OPEN-ENDED

FLEXION RESISTANCE

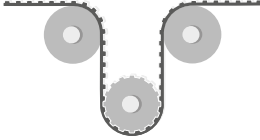
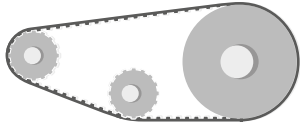
			
	Z_{MIN}	Z_{MIN} IDLER MIN DIA (MM)	Z_{MIN} IDLER MIN DIA (MM)
Standard steel cords	25	28 100	25 80

JOINED BELT INFORMATION:



- Minimum splice length 900 mm
- Traction and tooth resistances = 50% less than open-ended
- Joined belt can be used only in conveyor systems
- Rolls with NFT, NFB, and AVAFC can be joined too
- Minimum diameters according above table
- For coated belts, minimum diameters on page 134

PULLEYS

(FOR MORE DETAILS PLEASE SEE OUR PULLEYS CATALOGUE)

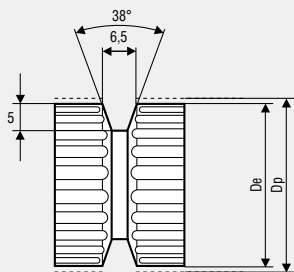

N° TEETH	DP	DE
25	39,79	38,96
27	42,97	42,14
30	47,75	46,92
32	50,93	50,10
36	57,30	56,47
40	63,66	62,93
48	76,39	75,57
60	95,49	94,67

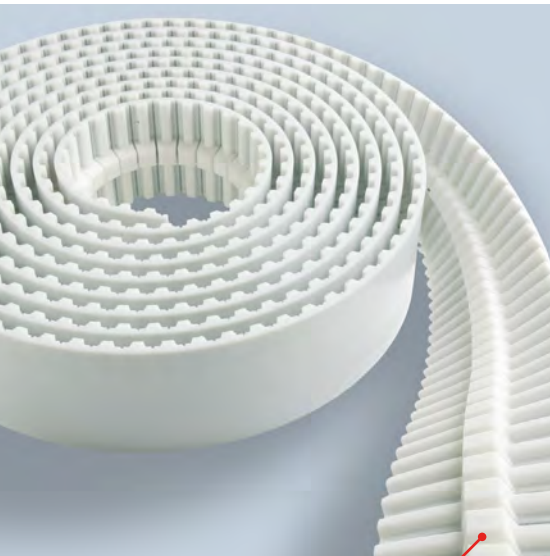

MEGALINEAR

ATG10 OPEN-ENDED

STANDARD	25ATG10	32ATG10	50ATG10	75ATG10	100ATG10	150ATG10	50ATG10
WIDTHS (mm)	K13	K13	K13	K13	K13	K13	K6
Weight (gr/m)	180	230	330	465	620	930	290

Standard compound	white polyurethane thermoplastic 92 ShA
Standard back cover	none
Standard tooth cover	none
Standard cords	S and Z torsion zinked steel
Standard width tolerance	+/- 0,5 mm
Standard length tolerance	+/- 0,8 mm/m
Standard roll length	100 m

Nylon fabric back
Nylon fabric teeth*
Antistatic nylon fabric
Transparent FDA compound
AVAFC 60/70/85 ShA
Cleats

Belt options on request
with minimum quantity

NOTCHED GUIDE

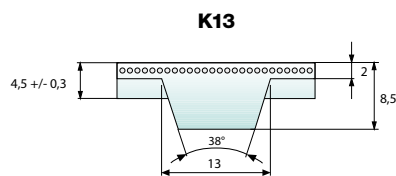
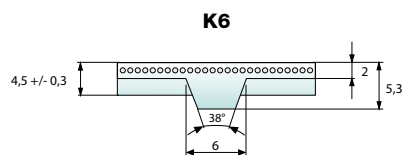

Different back coating materials see page 134

**K13 - Nylon fabric teeth excluding guide (2 fabric strips on teeth only) is standard version.*

Nylon fabric teeth including guide (fabric on complete width) is only on request.

K6 - Nylon fabric teeth including guide (fabric on complete width) is standard version.

Nylon fabric teeth excluding guide (2 fabric strips on teeth only) is only on request.

TOOTH RESISTANCE

RPM (1/min)	0	20	40	60	80	100	200	300	400	500	750	1000	1500	2000	3000	4000	5000	8000
$F_{p\ spec}$ (N/cm)	74	72	71	71	70	69	65	62	60	58	53	50	44	40	35	30	27	20

Minimum suggested number of teeth in clamp for linear movement: 7

TRACTION RESISTANCE

CORD MATERIAL	BELT WIDTH (MM)	25ATG10	32ATG10	50ATG10	75ATG10	100ATG10	150ATG10	50ATG10
		K13	K13	K13	K13	K13	K13	K6
Steel	Max Traction Load (N)	3800	4750	8075	13000	17500	28225	8075
	Breaking Strength (N)	15200	19000	32300	49400	66500	98800	32300
	Elongation at MTL (mm/m)	4	4	4	4	4	4	4
Kevlar	Max Traction Load (N)	5045	6730	10935	17715	23915	39425	10935
	Breaking Strength (N)	20195	26925	43755	67315	90875	138000	43755
	Elongation at MTL (mm/m)	8	8	8	8	8	8	8
HP	Max Traction Load (N)	5190	6920	11245	18210	24580	40530	-
	Breaking Strength (N)	20760	27680	44980	69200	93420	141860	-
	Elongation at MTL (mm/m)	4	4	4	4	4	4	-
Stainless	Max Traction Load (N)	3175	3970	6745	-	-	-	6745
	Breaking Strength (N)	12700	15880	26995	-	-	-	26995
	Elongation at MTL (mm/m)	3,8	3,8	3,8	-	-	-	3,8

Average values

MEGALINEAR



MEGALINEAR

TG10 OPEN-ENDED

FLEXION RESISTANCE

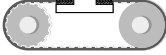
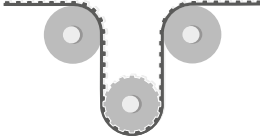
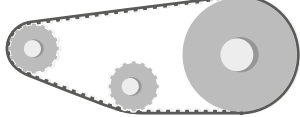
			
	Z_{MIN}	Z_{MIN} IDLER MIN DIA (MM)	Z_{MIN} IDLER MIN DIA (MM)
Standard steel cords	25	28 120	25 80
Kevlar cords	25	28 120	25 100
High Power cords	40	40 160	40 120
Stainless steel cords	32	34 130	32 130

JOINED BELT INFORMATION:



- Minimum splice length 900 mm
- Traction and tooth resistances = 50% less than open-ended
- Joined belt can be used only in conveyor systems
- Rolls with NFT, NFB, and AVAFC can be joined too
- Minimum diameters according above table
- For coated belts, minimum diameters on page 134

PULLEYS

(FOR MORE DETAILS PLEASE SEE OUR PULLEYS CATALOGUE)

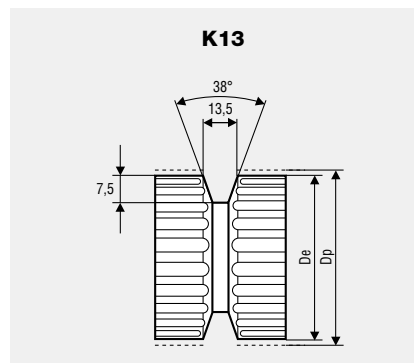
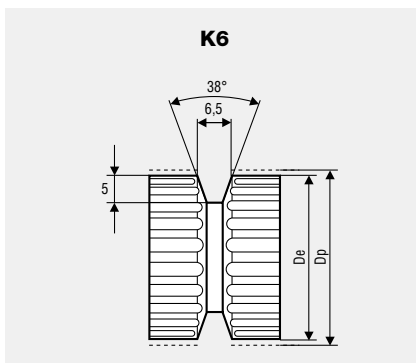

N° TEETH	DP	DE
25	79,58	77,73
27	85,94	84,10
30	95,49	93,65
32	101,86	100,01
36	114,59	112,74
40	127,32	125,48
48	152,79	150,94
60	190,99	189,14

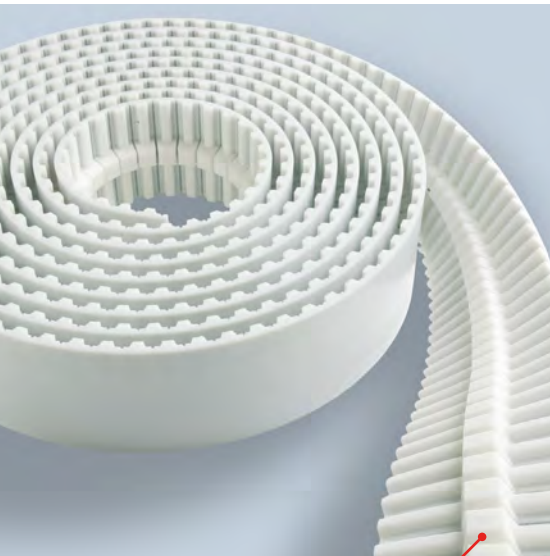

MEGALINEAR

ATG20 OPEN-ENDED

STANDARD WIDTHS (mm)	75	150
Weight (gr/m)	795	1500

Standard compound	white polyurethane thermoplastic 92 ShA
Standard back cover	none
Standard tooth cover	none
Standard cords	S and Z torsion zinked steel
Standard width tolerance	+/- 1 mm
Standard length tolerance	+/- 0,8 mm/m
Standard roll length	100 m

Belt options on request with minimum quantity	Nylon fabric back
	Nylon fabric teeth*
	Antistatic nylon fabric
	Transparent FDA compound
	AVAFC 60/70/85 ShA
	Cleats

NOTCHED GUIDE

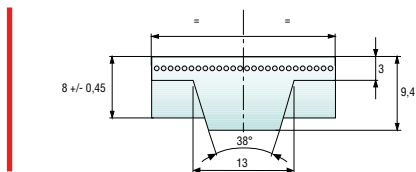

Different back coating materials see page 134

*Nylon fabric teeth excluding guide (2 fabric strips on teeth only).

TOOTH RESISTANCE

RPM (1/min)	0	20	40	60	80	100	200	300	400	500	750	1000	1500	2000	3000	4000	5000
F _{p spec} (N/cm)	147	144	142	139	137	135	126	119	112	107	97	88	76	67	58	43	35

Minimum suggested number of teeth in clamp for linear movement: 7

TRACTION RESISTANCE

CORD MATERIAL	BELT WIDTH (MM)	75	150
		Max Traction Load (N)	18210
Steel	Breaking Strength (N)	69200	141860
	Elongation at MTL (mm/m)	4	4

Average values



MEGALINEAR

ATG20 OPEN-ENDED

FLEXION RESISTANCE

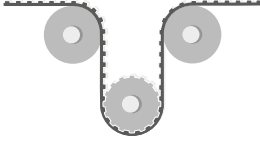
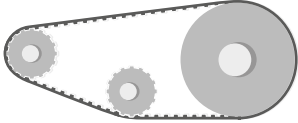
			
	Z _{MIN}	Z _{MIN} IDLER MIN DIA (MM)	Z _{MIN} IDLER MIN DIA (MM)
Standard steel cords	30	34 180	30 160

JOINED BELT INFORMATION:



- Minimum splice length 900 mm
- Traction and tooth resistances = 50% less than open-ended
- Joined belt can be used only in conveyor systems
- Rolls with NFT, NFB, and AVAFC can be joined too
- Minimum diameters according above table
- For coated belts, minimum diameters on page 134

PULLEYS

(FOR MORE DETAILS PLEASE SEE OUR PULLEYS CATALOGUE)

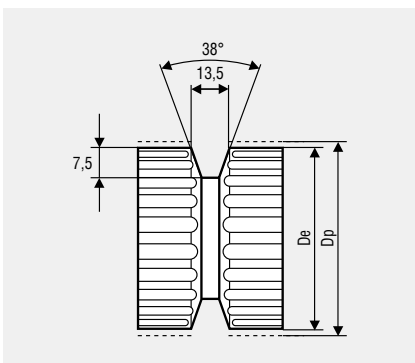

N° TEETH	DP	DE
30	190,99	188,13
32	203,72	200,86
36	229,18	226,33
40	254,65	251,80
48	305,58	302,73
60	381,97	379,12

MEGALINEAR

QST5 OPEN-ENDED

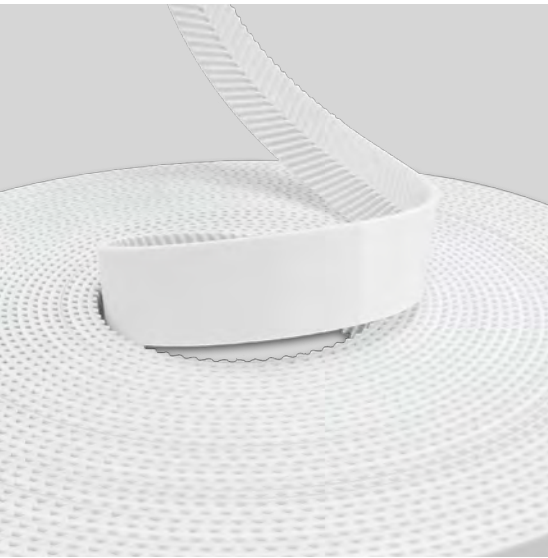

STANDARD WIDTHS (mm)	12	24
Weight (gr/m)	60	120

Standard compound	white polyurethane thermoplastic 92 ShA
Standard back cover	none
Standard tooth cover	nylon fabric (NFT)
Standard cords	S and Z torsion zinked steel
Standard width tolerance	-/+ 0,5 mm
Standard length tolerance	-/+ 0,5 mm/m
Standard roll length	100 m
Standard thickness tolerance	-/+ 0,2

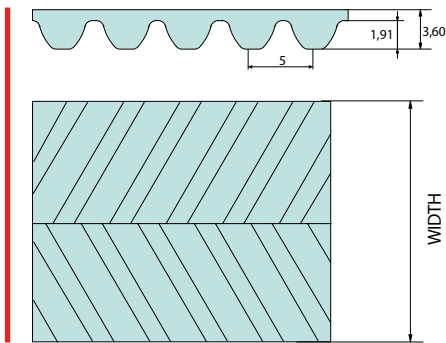

Different back coating materials see page 134
Please ask the feasibility to customer service or OEM team.

TOOTH RESISTANCE

RPM (1/min)	0	20	40	60	80	100	200	300	400	500	750
F _{p spec} (N/cm)	38	37	37	36	36	35	34	33	32	31	30

TOOTH RESISTANCE (CONT.)

RPM (1/min)	1000	1250	1500	1750	2000	2500	3000	3500	4000	5000	8000
F _{p spec} (N/cm)	28	27	26	25	24	22	21	19	19	17	11

Minimum suggested number of teeth in clamp for linear movement: 7

TRACTION RESISTANCE

CORD MATERIAL	BELT WIDTH (MM)	12	24
Steel	Max Traction Load (N)	1135	2497
	Breaking Strength (N)	4200	9240
	Elongation at MTL (mm/m)	4	4

Average values



MEGALINEAR

QST5 OPEN-ENDED

FLEXION RESISTANCE

	Z _{MIN}	Z _{MIN}	Z _{MIN}	Z _{MIN}
		IDLER MIN DIA (MM)	IDLER MIN DIA (MM)	
Standard steel cords	16	25	60	16
				30

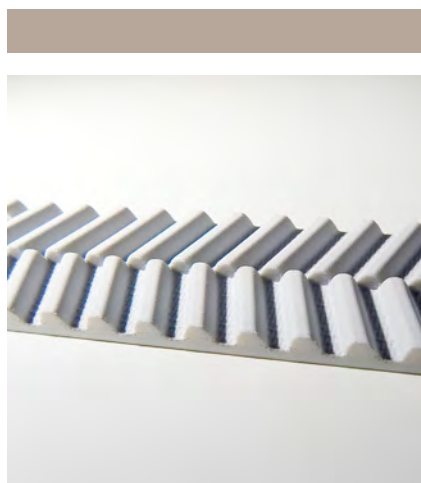

JOINED BELT INFORMATION:

- Minimum splice length 900 mm
- Traction and tooth resistances = 50% less than open-ended
- Joined belt can be used only in conveyor systems
- Rolls with NFT, NFB, and AVAFC can be joined too
- Minimum diameters according above table
- For coated belts, minimum diameters on page 134

PULLEYS

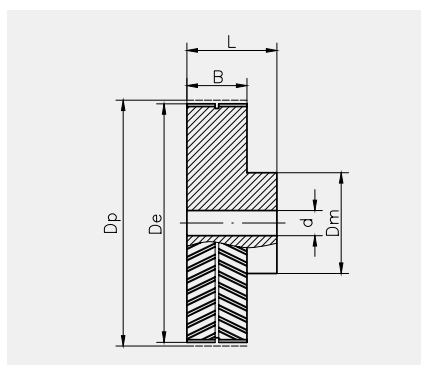

N° TEETH	DP	DE
16	25,46	24,32
18	28,65	27,5
20	31,83	30,69
21	33,42	32,28
22	35,01	33,87
24	38,2	37,05
26	41,38	40,24
28	44,56	43,42

N° TEETH	DP	DE
30	47,75	46,6
32	50,93	49,79
36	57,3	56,15
40	63,66	62,52
44	70,03	68,89
48	76,39	75,25
60	95,49	94,35
72	114,59	113,45

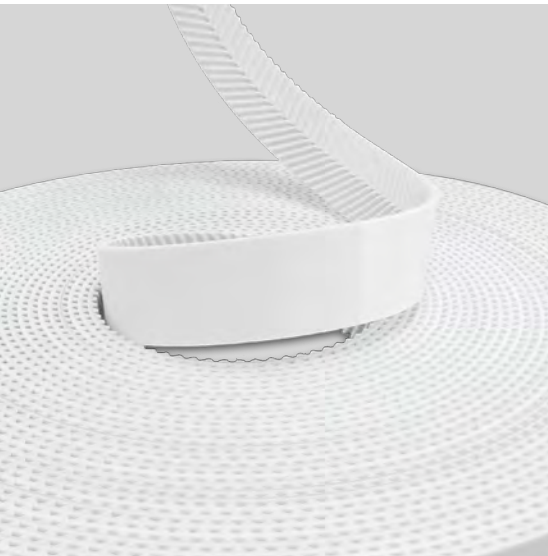

MEGALINEAR

QST8 OPEN-ENDED

STANDARD WIDTHS (mm)	16	25	32	50
Weight (gr/m)	85	145	180	300

Standard compound	white polyurethane thermoplastic 92 ShA
Standard back cover	none
Standard tooth cover	nylon fabric (NFT)
Standard cords	S and Z torsion zinked steel
Standard width tolerance	-/+ 0,5 mm
Standard length tolerance	-/+ 0,8 mm/m
Standard roll length	100 m
Standard thickness tolerance	-/+ 0,3

STEEL CORDS

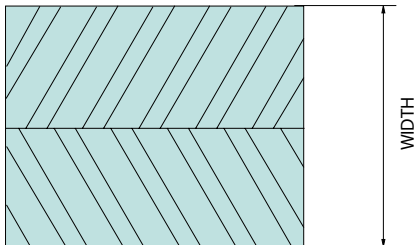
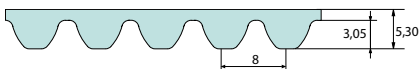

HP

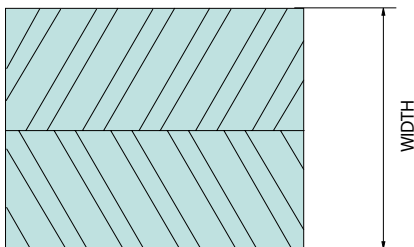
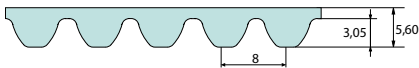

Different back coating materials see page 134

Please ask the feasibility to customer service or OEM team

TOOTH RESISTANCE

RPM (1/min)	0	20	40	60	80	100	200	300	400	500	750
F _{p spec} (N/cm)	85	83	82	81	80	79	75	71	68	66	61

TOOTH RESISTANCE (CONT.)

RPM (1/min)	1000	1250	1500	1750	2000	2500	3000	3500	4000	5000	8000
F _{p spec} (N/cm)	57	54	51	48	46	43	40	37	35	31	23

Minimum suggested number of teeth in clamp for linear movement: 7

HP cords minimum suggested number of teeth in clamp 10

TRACTION RESISTANCE

CORD MATERIAL	BELT WIDTH (MM)	16	25	32**	50**
Steel	Max Traction Load (N)	2610	4275	5460	8785
	Breaking Strength (N)	10450	17100	21850	35150
	Elongation at MTL (mm/m)	4	4	4	4
HP	Max Traction Load (N)	3740	6545	8415	14025
	Breaking Strength (N)	13840	24220	31140	51900
	Elongation at MTL (mm/m)	4	4	4	4

Average values

**HP VERSION Under construction

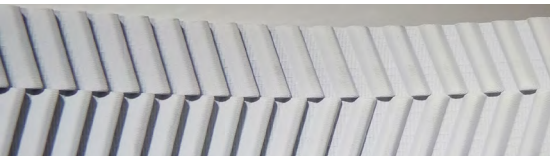

MEGALINEAR

QST8 OPEN-ENDED

FLEXION RESISTANCE

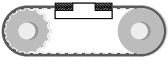
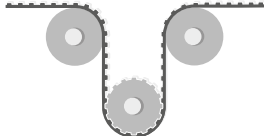
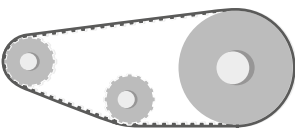
			
	Z_{MIN}	Z_{MIN} IDLER MIN DIA (MM)	Z_{MIN} IDLER MIN DIA (MM)
Standard steel cords	32	32 200	32 140
Extra high power cords	32	32 200	32 140

JOINED BELT INFORMATION:



JOINED BELT INFORMATION:

- Minimum splice length 900 mm
- Traction and tooth resistances = 50% less than open-ended
- Joined belt can be used only in conveyor systems
- Rolls with NFT, NFB, and AVAFC can be joined too
- Minimum diameters according above table
- For coated belts, minimum diameters on page 134

PULLEYS

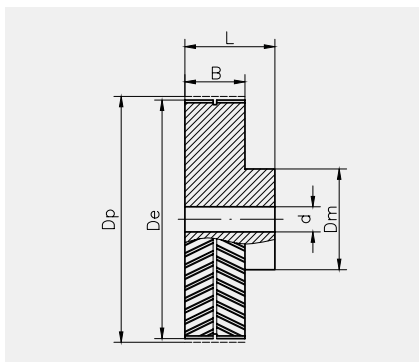

N° TEETH	DP	DE
32	142,61	139,81
34	151,52	148,73
36	160,43	157,64
38	169,35	166,55
40	178,26	175,46
48	213,91	211,12

MEGALINEAR

QST14 OPEN-ENDED

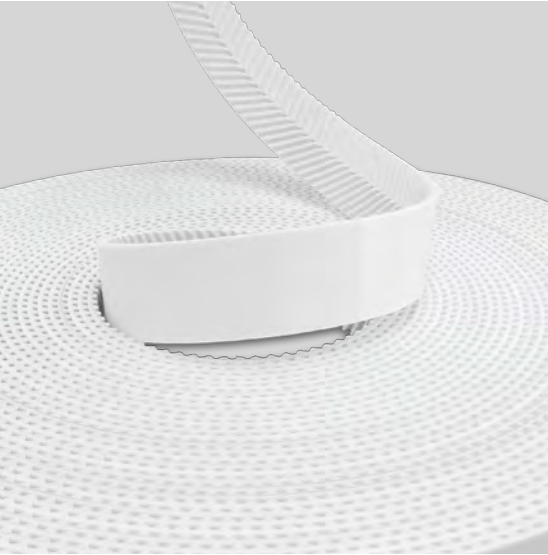

STANDARD WIDTHS (mm)	35	52,5	70	105
Weight (gr/m)	400	600	800	1200

Standard compound	white polyurethane thermoplastic 92 ShA
Standard back cover	none
Standard tooth cover	nylon fabric (NFT)
Standard cords	S and Z torsion zinked steel
Standard width tolerance	-/+ 1 mm
Standard length tolerance	-/+ 0,8 mm/m
Standard roll length	100 m
Standard thickness tolerance	-/+ 0,4

STEEL CORDS

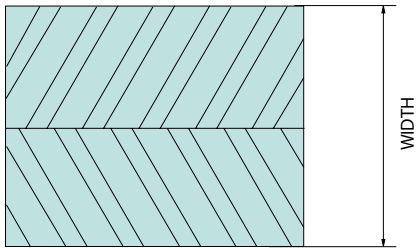
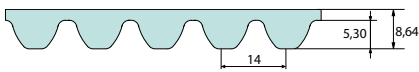

XHP CORDS

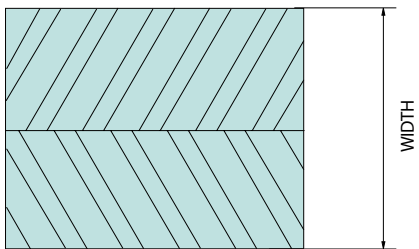
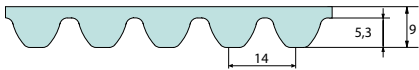

Different back coating materials see page 134

Please ask the feasibility to customer service or OEM team

TOOTH RESISTANCE

RPM (1/min)	0	20	40	60	80	100	200	300	400	500
F _{p spec} (N/cm)	160	157	154	152	149	147	137	130	122	117

TOOTH RESISTANCE (CONT.)

RPM (1/min)	750	1000	1250	1500	1750	2000	2500	3000	3500	4000
F _{p spec} (N/cm)	105	96	89	83	77	72	64	57	50	47

Minimum suggested number of teeth in clamp for linear movement: 7

XHP cords minimum suggested number of teeth in clamp 10

TRACTION RESISTANCE

CORD MATERIAL	BELT WIDTH (MM)	35	52,5	70**	105**
Steel	Max Traction Load (N)	11200	17680	23575	36210
	Breaking Strength (N)	44800	67200	89600	137600
	Elongation at MTL (mm/m)	4	4	4	4
XHP	Max Traction Load (N)	15155	26525	34105	53050
	Breaking Strength (N)	57600	100800	129600	201600
	Elongation at MTL (mm/m)	4	4	4	4

Average values

**XHP VERSION Under construction

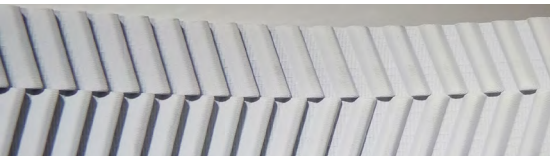

MEGALINEAR

QST14 OPEN-ENDED

FLEXION RESISTANCE

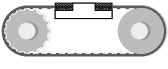
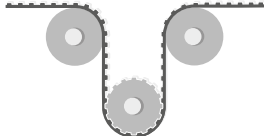
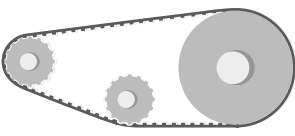
			
	Z_{MIN}	Z_{MIN} IDLER MIN DIA (MM)	Z_{MIN} IDLER MIN DIA (MM)
Standard steel cords	20	30 120	20 50
High Power cords	30	32 150	30 80

JOINED BELT INFORMATION:



JOINED BELT INFORMATION:

- Minimum splice length 900 mm
- Traction and tooth resistances = 50% less than open-ended
- Joined belt can be used only in conveyor systems
- Rolls with NFT, NFB, and AVAFC can be joined too
- Minimum diameters according above table
- For coated belts, minimum diameters on page 134

PULLEYS

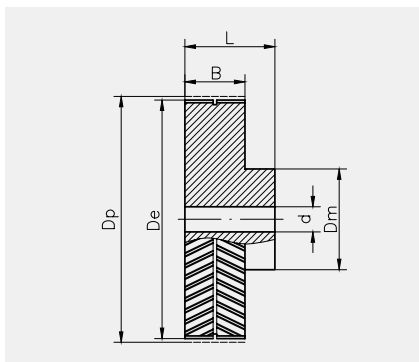

N° TEETH	DP	DE
18	45,84	44,47
22	56,02	54,65
24	61,12	59,75
26	66,21	64,84
28	71,3	69,93
30	76,4	75,03
32	81,49	80,12
34	86,58	85,21

N° TEETH	DP	DE
36	91,68	90,3
38	96,77	95,4
40	101,86	100,49
44	112,05	110,68
48	122,23	120,86
52	132,42	131,05
60	152,79	151,42

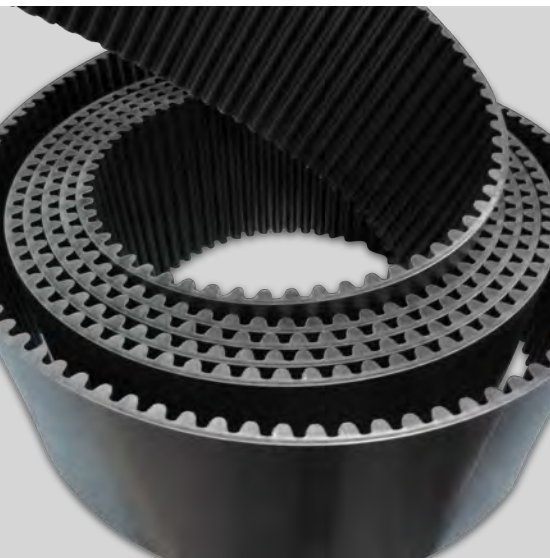

MEGALINEAR

GW14 OPEN-ENDED

STANDARD WIDTHS (mm)	50	100	150	200
Weight (gr/m)	740	1500	2250	3000

Standard compound	black polyurethane thermoplastic 96 ShA
Standard back cover	none
Standard tooth cover	nylon fabric (NFT)
Standard cords	S and Z torsion zinked steel
Standard width tolerance	-/+ 1 mm
Standard length tolerance	+0 -0,6 mm/m
Standard roll length	100 m
Suggestions	this type of belts must be well pre-tensioned.

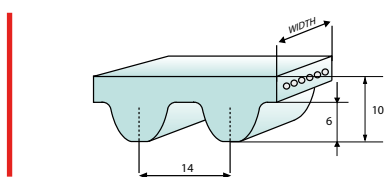

TOOTH RESISTANCE

RPM (1/min)	0	20	40	60	80	100	200	300	400	500
F _{p spec} (N/cm)	155	152	149	147	145	142	131	123	116	112

Linear speed over 7m/s, please contact our technical department

Minimum suggested number of teeth in clamp for linear movement: 13

TRACTION RESISTANCE

CORD MATERIAL	BELT WIDTH (MM)	50	100	150	200
Steel	Max Traction Load (N)	28400	60600	92800	123100
	Breaking Strength (N)	108000	230400	352800	468000
	Elongation at MTL (mm/m)	5,5	5,5	5,5	5,5

Average values



MEGALINEAR

GW14 OPEN-ENDED

FLEXION RESISTANCE

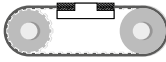
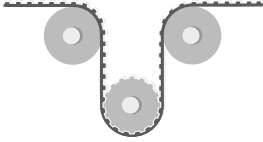
		
	Z_{MIN}	Z_{MIN} IDLER MIN DIA (MM)
Standard steel cords	32	36 250

PULLEYS

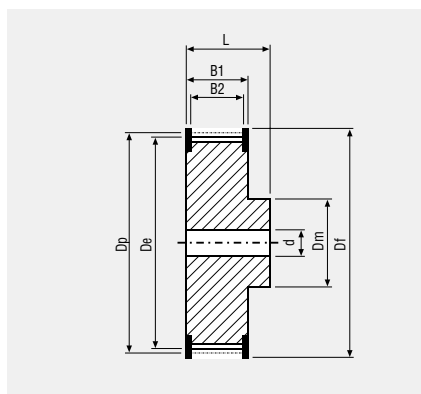

N° TEETH	DP	DE
32	142,6	139,8
34	151,52	148,72
36	160,43	157,63
38	169,34	166,54
40	178,25	175,45
44	196,08	193,28
48	213,9	211,1
56	249,56	246,76
64	285,21	282,41
72	320,86	318,06
80	356,51	353,71
90	401,07	398,27

*Suggestions: material steel.
Use only pulley with gw profile.
Flanges 3,5mm fixed with screws.
B2= belt's width+16 mm.*

TYPICAL APPLICATION: AUTOMATIC WAREHOUSE



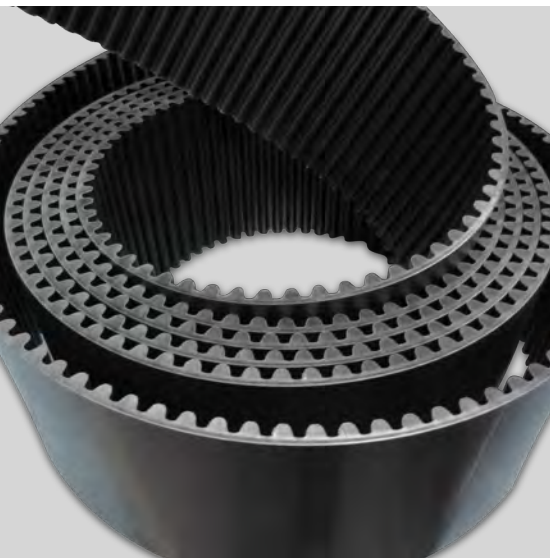

MEGALINEAR

GW20 OPEN-ENDED

STANDARD WIDTHS (mm)	50	100	150	200
Weight (gr/m)	1050	2030	3040	4060

Standard compound	black polyurethane thermoplastic 96 ShA
Standard back cover	none
Standard tooth cover	nylon fabric (NFT)
Standard cords	S and Z torsion zinked steel
Standard width tolerance	-/+ 2 mm
Standard thickness	14,3 +/- 0,6 mm
Standard length tolerance	+0 - 1,6mm/m
Standard roll length	100 m
Suggestions	this type of belts must be well pre-tensioned.

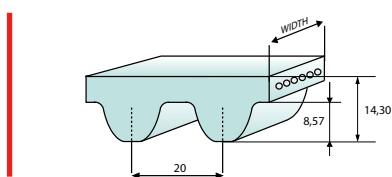

TOOTH RESISTANCE

RPM (1/min)	0	20	40	60	80	100	200	300	400	500
F _{p spec} (N/cm)	210	207	198	192	187	182	168	158	150	144

Linear speed over 7m/s, please contact our technical department

Minimum suggested number of teeth in clamp for linear movement: 15

TRACTION RESISTANCE

CORD MATERIAL	BELT WIDTH (MM)	50	100	150	200
		Max Traction Load (N)	37900	78900	120000
Steel	Breaking Strength (N)	144000	300000	456000	612000
	Elongation at MTL (mm/m)	5,5	5,5	5,5	5,5

Average values



MEGALINEAR

GW20 OPEN-ENDED

FLEXION RESISTANCE

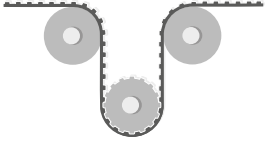
		
	Z_{MIN}	Z_{MIN} IDLER MIN DIA (MM)
Standard steel cords	38	44 380

PULLEYS

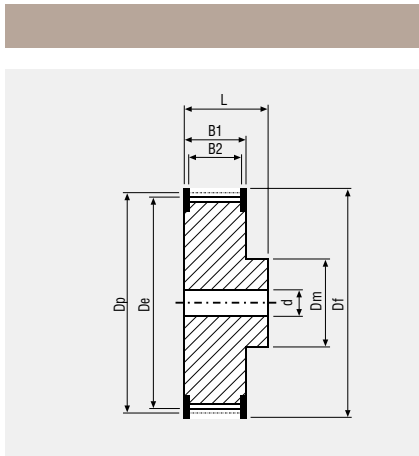

N° TEETH	DP	DE
38	241,92	237,6
40	254,65	250,33
44	280,11	275,79
48	305,58	301,26
56	356,51	352,19
64	407,44	403,12
72	458,37	454,05
80	509,3	504,98

*Suggestions: material steel.
Use only pulley with gw profile.
Flanges 3,5mm fixed with screws.
B2= belt's width+16 mm.*

TYPICAL APPLICATION: AUTOMATIC WAREHOUSE





MEGALINEAR

FLAT OPEN-ENDED

	10 P1	20 P1	25 P2	50 P2	75 P2	100 P2
Weight (gr/m)	20	40	135	245	370	490
polyurethane 92 ShA	blue	blue	white	white	white	white
Width tolerance(mm)	10±0,5	20±0,5	25±0,5	50±0,5	75±0,5	100±0,5
Thickness (mm)	1±0,1	1±0,1	2±0,2	2±0,2	2±0,2	2±0,2
Gap	Straight	Straight	Straight	Straight	Straight	Straight

	30 P3	60 P3	100 P3	120 P3	25 P4	50 P4	100 P4
Weight (gr/m)	213	426	710	852	220	445	890
polyurethane 92 ShA	black	black	black	black	transparent	transparent	transparent
Width (mm)	30±0,5	60±0,5	100±0,5	120±0,5	25±0,5	50±0,5	100±0,5
Thickness (mm)	3,2+/-0,2	3,2+/-0,2	3,2+/-0,2	3,2+/-0,2	4+0,4/-0	4+0,4/-0	4+0,4/-0
Gap	Helical	Helical	Helical	Helical	Straight	Straight	Straight

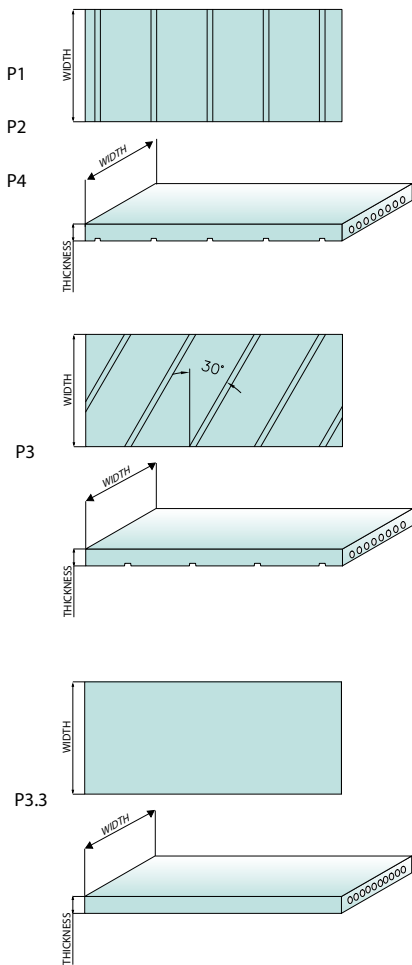

Standard back cover	none
Standard tooth cover	none
Standard cords	S and Z torsion zinked steel
Standard roll length	100 m
Belt options on request with minimum quantity	Nylon fabric back Nylon fabric teeth Antistatic nylon fabric No gap Silicon free compound

Special thickness tolerances by grinding (suggested for applications with rolled belts)

TRACTION RESISTANCE							
CORD MATERIAL	BELT WIDTH (MM)	10 P1	20 P1	25 P2	50 P2	75 P2	100 P2
Steel	Max Traction Load (N)	490	980	3800	8075	13000	17500
	Breaking Strength (N)	1965	3935	15200	32300	49400	66500
	Elongation at MTL (mm/m)	4	4	4	4	4	4
HP	Max Traction Load (N)	-	-	5190	11245	18210	24580
	Breaking Strength (N)	-	-	20760	44980	69200	93420
	Elongation at MTL (mm/m)	-	-	4	4	4	4

TRACTION RESISTANCE								
CORD MATERIAL	BELT WIDTH (MM)	30 P3	60 P3	100 P3	120 P3	25 P4	50 P4	100 P4
Steel	Max Traction Load (N)	9120	19200	32000	42560	8000	16000	34525
	Breaking Strength (N)	36480	72960	121600	148960	32000	64000	131200
	Elongation at MTL (mm/m)	4	4	4	4	4	4	4

MEGALINEAR

FLAT OPEN-ENDED

FLEXION RESISTANCE

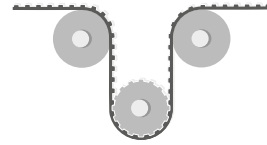
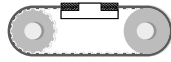

	DRIVER PULLEY MIN DIA (MM)	DRIVER PULLEY MIN DIA (MM)	IDLER MIN DIA (MM)
Standard steel cords P1	16	25	30
Standard steel cords P2	45	50	90
High Power cords P2	56	62	150
Standard steel cords P3	100	110	150
Standard steel cords P4	100	110	150

FIXING PLATES

DIMENSION OF THE FIXING PLATES

Belt type	Clamping plates dimensions (mm)					Suggested clamping plate width W (mm)								
	L1	C	D	T	R _{min}	10	20	25	30	50	60	75	100	120
P1	20	25	16	3	10	20	20	30	-	-	-	-	-	-
P2	25	30	20	3	10	-	-	50	-	75	-	100	-	-
P2 HP	25	30	20	3	10	-	-	50	-	75	-	100	-	-
P3	30	75	50	5	25	-	-	-	60	-	90	-	132	160
P4	30	120	80	7	40	-	-	-	-	75	-	-	125	-

SUGGESTION ABOUT THE FIXING SCREW

Belt type	Screw type	Belt width (mm)												
		10	20	25	30	50	60	75	100	120				
P1	M5	4	4	-	-	-	-	-	-	-	-	-	-	-
P2	M6	-	-	4	-	4	-	6	8	-	-	-	-	-
P2 HP	M6	-	-	4	-	6	-	8	10	-	-	-	-	-
P3	M8	-	-	-	4	-	6	-	8	12	-	-	-	-
P4	M10	-	-	4	-	4	-	-	6	-	-	-	-	-

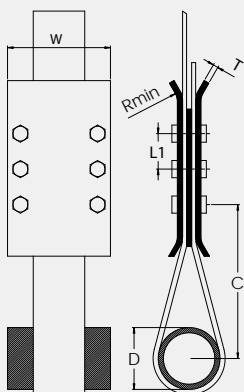

PULLEYS

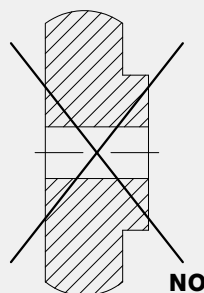
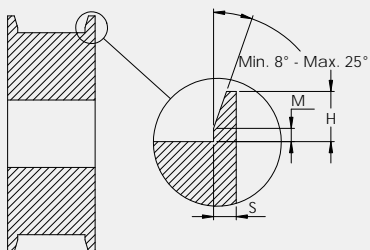

FLANGES ACCORDING THE TABLE

BELT TYPE	S (MM)	M (MM)	H (MM)
P1	1,5	0,4+0,3/0	2,1+0,25/0
P2	2,3	0,4+0,3/0	2,1+0,25/0
P2 HP	2,3	0,4+0,3/0	2,1+0,25/0
P3	3	0,9+0,5/0	5+0,25/0
P4	3	0,9+0,5/0	5+0,25/0

H: minimum height of flanges

S: minimum thickness of flanges

Rounded corner not quoted $R = 0,8$ mm

Suggested material: Alluminium or Zinked steel

Maximum superficial roughness: 1.6 Ra

MEGALINEAR

FC T5

Standar widths (mm)	25	32	50	75	100	150
Width tolerance(mm)	± 0,25	± 0,25	± 0,5	± 0,5	± 0,75	± 0,75

SMOOTH SURFACE

Standard compound	dark blue polyurethane thermoplastic 85 ShA
Total Thickness	2,8 +/- 0,3 mm
Height of the profile	0 mm
Standard cords	S and Z torsion Kevlar
Standard roll length	50 m

Belts produced with raw materials, in compliance with:

- FDA 21 CFR 177.2600 / 177.105 / 177.1680 (USA)
- USDA - NSF/ANSI/3-A 14159-3 – 2010 Hygienic Design (Meat and Poultry Processing).
- European Directives 82/711/EEC, 85/572/EEC, 93/8/EEC e 97/48/EEC
- Regulation (EC) n° 1935/2004 (art. 3, art.11, par.5, art.15, art.17) e 1895/2005 and (EU) n° 10/2011
- Belts produced according to the Regulation (EU) n° 2023/2006 GMP (Good Manufacturing Practice).

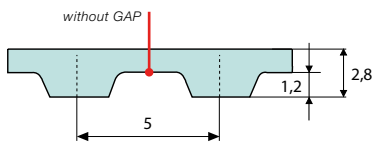

STANDARD SURFACES	TOTAL THICKNESS	PROFILE HEIGHT	ROLL
Smooth	2,8 ± 0,3 mm	0 mm	50 m
Longitudinal Ribbed	4,0 ± 0,3 mm	1,25 mm	50 m
Transversal Ribbed	4,0 ± 0,3 mm	1,25 mm	50 m
Noppen Oval	5,2 ± 0,3 mm	2,1 mm	50 m
Roof	Not currently available in T5 pitch		
Spike Top	4,1 ± 0,3 mm	1,3 mm	50 m

SMOOTH



NOPPEN OVAL



LONGITUDINAL RIBBED

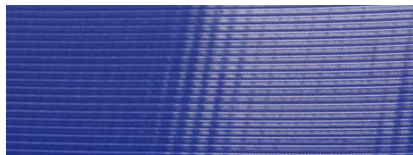

SPIKE TOP

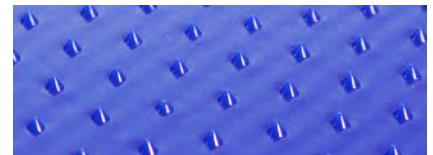

TRANSVERSAL RIBBED

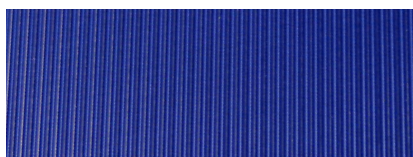



MEGALINEAR

FC T10

Standar widths (mm)	25	32	50	75	100	150
Width tolerance(mm)	± 0,25	± 0,25	± 0,5	± 0,5	±0,75	± 0,75

SMOOTH SURFACE

Standard compound	dark blue polyurethane thermoplastic 85 ShA
Total Thickness	4,8 +/- 0,3 mm
Height of the profile	0 mm
Standard cords	S and Z torsion Kevlar
Standard roll length	50 m

Belts produced with raw materials, in compliance with:

- FDA 21 CFR 177.2600 / 177.105 / 177.1680 (USA)
- USDA - NSF/ANSI/3-A 14159-3 – 2010 Hygienic Design (Meat and Poultry Processing).
- European Directives 82/711/EEC, 85/572/EEC, 93/8/EEC e 97/48/EEC
- Regulation (EC) n° 1935/2004 (art. 3, art.11, par.5, art.15, art.17) e 1895/2005 and (EU) n° 10/2011
- Belts produced according to the Regulation (EU) n° 2023/2006 GMP (Good Manufacturing Practice).

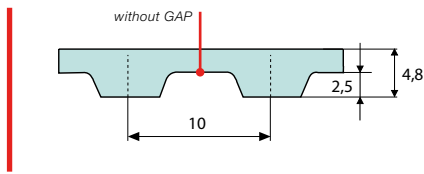

STANDARD SURFACES	TOTAL THICKNESS	PROFILE HEIGHT	ROLL
Smooth	4,8 +/- 0,3 mm	0 mm	50 m
Longitudinal Ribbed	6,05 +/- 0,3 mm	1,25 mm	50 m
Transversal Ribbed	6,05 +/- 0,3 mm	1,25 mm	50 m
Noppen Oval	7,7 +/- 0,3 mm	2,1 mm	50 m
Roof	6,2 +/- 0,3 mm	1,7 mm	50 m
Spike Top	6,1 +/- 0,3 mm	1,3 mm	50 m

SMOOTH



NOPPEN OVAL



LONGITUDINAL RIBBED

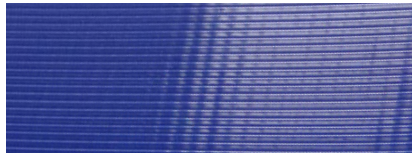

SPIKE TOP

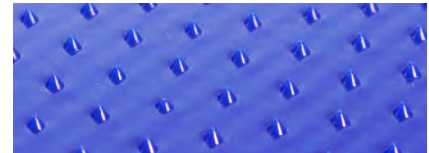

TRANSVERSAL RIBBED

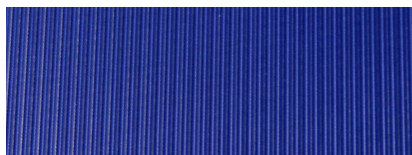

ROOF



FIXING PLATES

The fixing plates are used to fix the tail of the open belts. On the customer's request, the plates can be delivered with or without fixing holes. As the belt can't be stretched with the fixing plates we suggest to use other tension system. The plates are delivered in aluminium alloy.

The Megadyne Technical Staff is ready to study special or particular applications.

ALUMINIUM

CLAMPING PLATES FOR IMPERIAL PITCH BELTS

Pitch	F	d	B	A	S	BELT WIDTH								
						25	37	50	75	100	150	200	300	400
						C								
XL*	6	5,5	3,5	42,5	8	25,5	28,5	32	38	45	-	-	-	-
L*	8	9	5	76,5	15	-	-	39	45	51,5	64	77	-	-
H*	10	11	9	106,9	22	-	-	45	51	57,5	70	83	108	134

Dimensions in inches

ALUMINIUM

CLAMPING PLATES FOR HTD PITCH BELTS

Pitch	F	d	B	A	S	BELT WIDTH											
						6	9	10	15	20	25	30	40	50	55	85	115
						C											
5M*	6	5,5	3,25	41,5	8	25	28	-	34	-	44	-	-	-	-	-	-
8M*	8	9	5	66	15	-	-	35	40	45	-	55	-	75	-	110	-
14M*	10	11	9	116	22	-	-	-	-	-	56	-	71	-	86	116	146

ALUMINIUM

CLAMPING PLATES FOR METRIC PITCH BELTS

Pitch	F	d	B	A	S	BELT WIDTH								
						6	10	16	20	25	32	50	75	100
						C								
T5* AT5*	6	5,5	3,25	41,65	8	25	29	35	39	44	51	69	-	-
T10* AT10*	8	9	5	80	15	-	35	41	-	50	57	75	100	125
T20* AT20*	10	11	10	160	20	-	-	-	-	56	63	81	106	132

*Available in customized length | Dimensions in mm

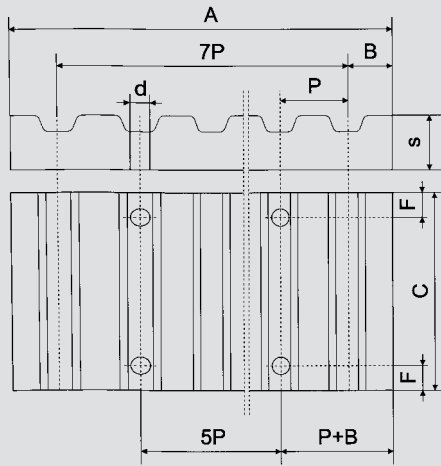

XL - L - H - T5 - T10 - T20 - AT5 - AT10 - AT20

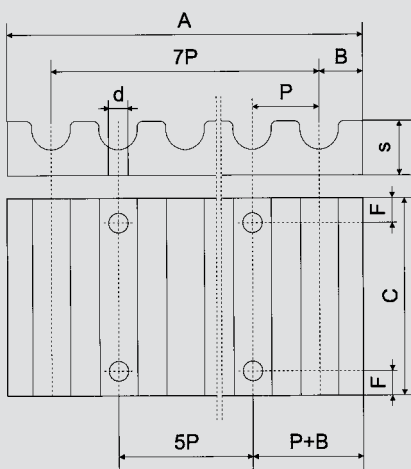

HTD

ORDER CODE EXAMPLE:

AT10 pitch clamping plate for 25 mm width belt.

FIXING PLATES QST

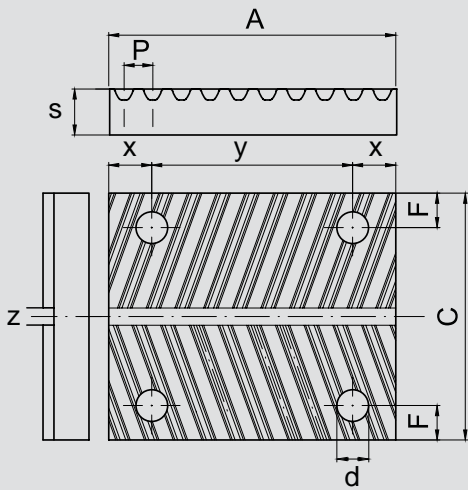

ALUMINIUM

CLAMPING PLATES FOR QST 5

Pitch	BELT WIDTH	F	d	A	S	x	y	z	C
QST 5*	12	6	5,5	50	8	7,5	35	3	43
	24	6	5,5	50	8	7,5	35	3	43

ALUMINIUM

CLAMPING PLATES FOR QST 8

Pitch	BELT WIDTH	F	d	A	S	x	y	z	C
QST 8*	16	7,5	9	74	14,5	13	48	3	40
	25	8	9	74	14,5	13	48	3	50
	32	8	9	74	14,5	13	48	3	57
	50	8	9	74	14,5	13	48	3	75

ALUMINIUM

CLAMPING PLATES FOR QST 14

Pitch	BELT'S WIDTH	F	d	A	S	x	y	z	C
QST 14	35	9,5	11	130	22	23	84	3	65
	52,5	9,5	11	130	22	23	84	3	82,5
	70	9,5	11	130	22	23	84	3	100
	105	10	11	130	22	23	84	3	136

*Available in customized length | Dimensions in mm

FIXING PLATES GW

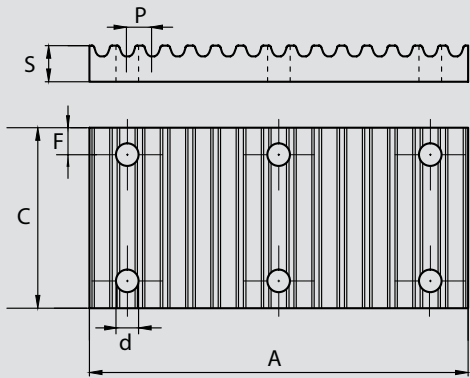

STEEL

CLAMPING PLATES FOR GW14

Pitch	BELT WIDTH	A	C	S	F	d	Screws UNI-EN 14399-8.8	N° of screws
GW14*	50	210	100	20	15	12,5	M12	2X3
	100	210	150	20	15	12,5	M12	2X3
	150	210	200	20	15	12,5	M12	2X5
	200	210	250	20	15	12,5	M12	2X6

STEEL

CLAMPING PLATES FOR GW20

Pitch	BELT WIDTH	A	C	S	F	d	Screws UNI-EN 14399-8.8	N° of screws
GW20*	50	340	110	36	15	16,5	M16	2X3
	100	340	160	36	15	16,5	M16	2X3
	150	340	210	36	15	16,5	M16	2X4
	200	340	260	36	15	16,5	M16	2X5

*Available in customized length | Dimensions in mm

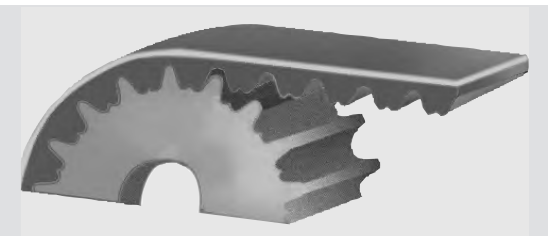

POSITIONING

AND TRANSMISSION PRECISION

Backlash between belt and pulley teeth is very important for positioning and transmission synchronism.

To improve transmission precision, it is possible to use zero or reduced backlash pulleys. Please note that these pulleys don't reduce the elasticity of belt teeth or cords.

Maximum recommend pulley teeth is:

Till 100	1/min	Z=40
Till 500	1/min	Z=30
Till 1000	1/min	Z=20

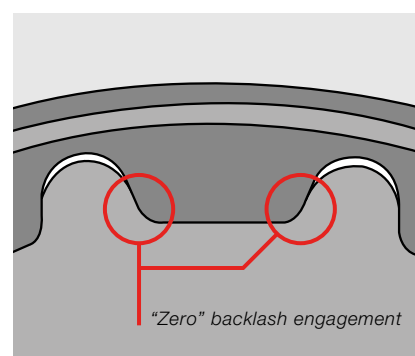
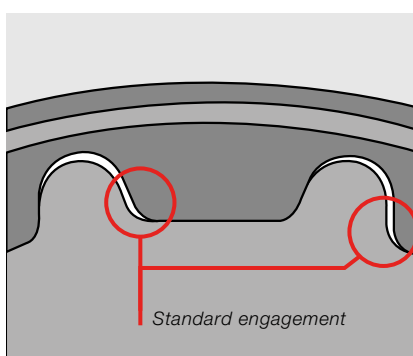

In following table there is a list of average values for backlashes:

AVAILABLE PITCH FOR "ZERO" BACKLASH PULLEY						
Average backlash value for standard	T5 XL	T10 L H	T20 XH	AT5	AT10	AT20
	0,6	1,2	2,4	0,2	0,4	0,8

RPP belts and pulleys offer great solution for positioning system because their parabolic profile reduces backlash and improves meshing quality.

CLEATS

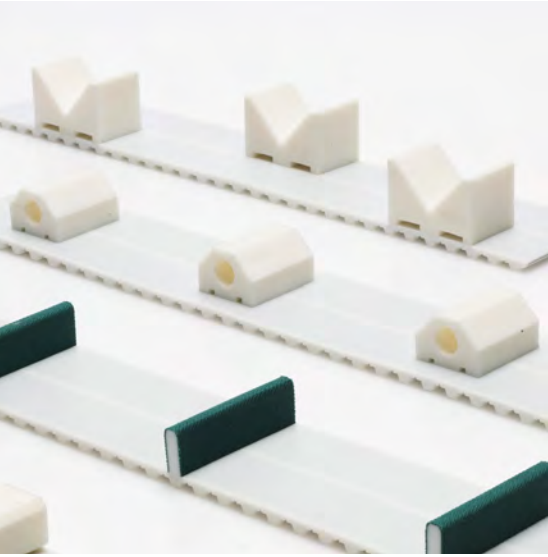

Megadyne timing belts can be customised with profiles vulcanised on the backside. All the cleats are made using the same thermoplastic polyurethane as the MEGALINEAR body (white PU 92 ShA).

The profiles are attached with the best technology now available, the High Vibration System.

The production process for these profiles is very flexible; Megadyne can design any profile to meet the specific requirement of the customer, in order to check and develop all the needed special profiles.

STANDARD PARALLELEPIPED PROFILES

Megadyne can produce, as standard cleats, the parallelepiped profiles, starting from a thermoplastic polyurethane strip roll and cutting until the requested profile dimension.

The t value (thickness) is available from 2 until 13 mm, the h value (height) can be from 3 until 120 mm and the width can be 150 mm maximum.

Megadyne recommend that the profile spacing were multiple of the belt pitch; in any case, for special inquiries and small quantities, it is possible to weld the profiles also in others positions; the feasible dimensions, with the standard process tolerances, are introduced in the following sketch.

The tolerances on the position are ± 0.5 mm.

The cumulative tolerance on the spacing of the profiles is the same of the length tolerance for our standard belts (± 0.8 mm/m) (tighter tolerances are available on request).

Due to the welding process, a bead of material develops at the meeting point of profile and belt.

In any case, Megadyne always remove this welding bead.

PROFILE MECHANICAL RESISTANCE

In order to find the right cleat dimensions, please consider the following factors:

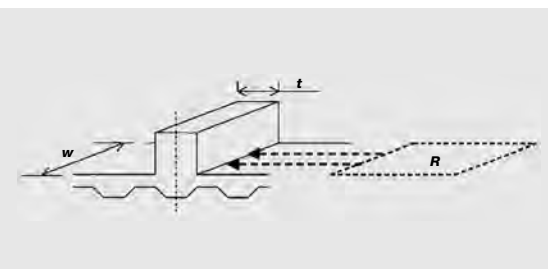
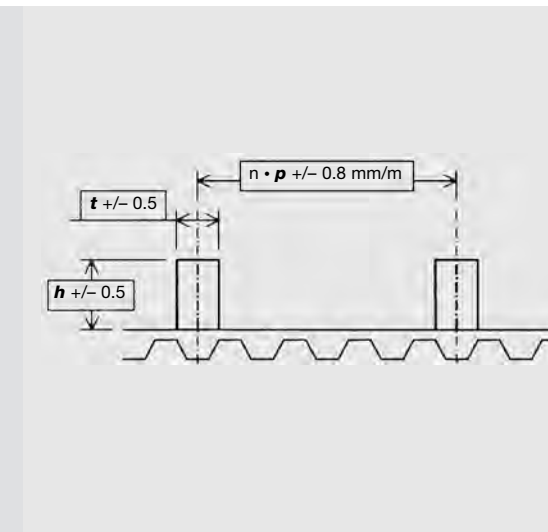



CLEATS

SECTION BASE CLEATS RESISTANCE (R) BECOMES BIGGER, INCREASING:

- Cleats width (w)
- Cleats thickness (t)

CLEAT STIFFNESS IS BIGGER:

- Increasing cleat thickness (t)
- Using special moulded profiles, like STDE0006, STDE0008, STDE0010 and STMI0012 types

MIN. N° OF PULLEY TEETH FOR BELTS WITH PROFILES

The profiles presence can change the belt flexibility properties; the two factors that affect the original flexibility are the following:

- thickness of the cleat “foot” (size of the base). Flexibility decreases when welded area dimensions increase
- position of the welded profile on the belt. When the cleats are welded in axis with the teeth, belt flexibility is better than when cleats are welded in axis with the little nose.

Please find, in the following table, flexibility properties for the cleated belts.

CLEATS OVER A TOOTH						
CLEAT THICKNESS	4	5	6	8	10	12
XL	18	18	25	40	50	100
L	12	12	18	30	40	60
H	14	14	14	18	25	45
XH	18	18	18	28	18	20
T5/AT5	18	18	25	40	50	100
T10/AT10	14	14	14	18	25	45
T20/AT20	18	18	18	18	18	20
RPP5	18	18	25	40	50	100
RPP8	14	14	14	18	25	45
RPP14	18	18	18	18	18	20

CLEATS NOT OVER A TOOTH						
CLEAT THICKNESS	4	5	6	8	10	12
XL	45	45	50	60	100	-
L	40	40	45	55	60	80
H	25	25	30	45	50	65
XH	20	20	30	40	45	54
T5/AT5	45	45	50	60	100	-
T10/AT10	30	30	40	45	50	65
T20/AT20	20	20	30	40	45	54
RPP5	45	45	50	60	100	-
RPP8	30	30	40	45	50	65
RPP14	20	20	30	40	45	54

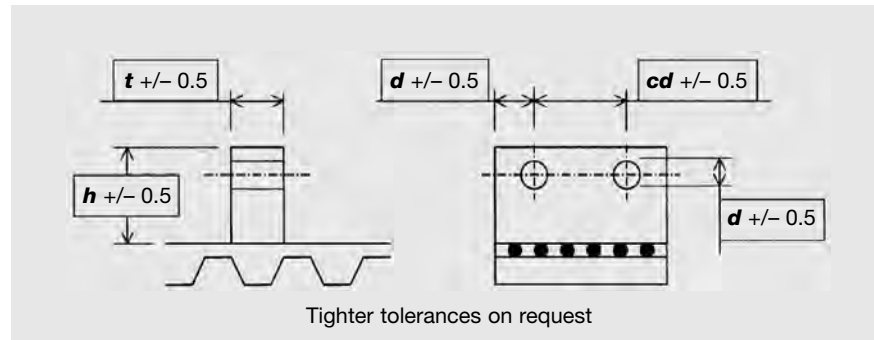

STANDARD PARALLELEPIPED PROFILES WITH HOLES

Parallelepiped profiles are available also with holes, to satisfy specials applications; please find below the standard tolerances for this kind of cleats.

Please find, in the following table, flexibility properties for the cleated belts.

For belt flexibility and mechanical resistance, please kindly refer to values for cleats without holes.

MOULDED CLEATS

Using an high performance injection system, Megadyne can produce any profile designed by the customer. For cleats not yet present in following pages, Megadyne can produce dedicated mould according customer requirements. For belt flexibility and mechanical resistance, please kindly refer to standard parallelepiped profiles section.



CLEATS

If the needed cleat wouldn't yet present in the following tables, please contact MEGADYNE staff.

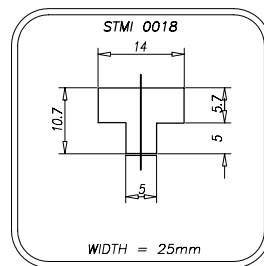
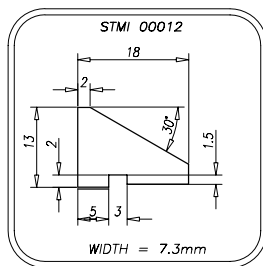
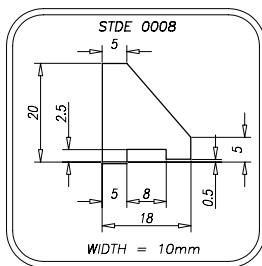
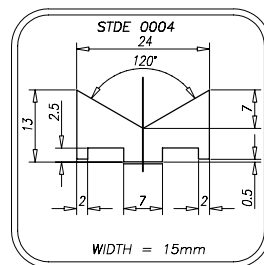
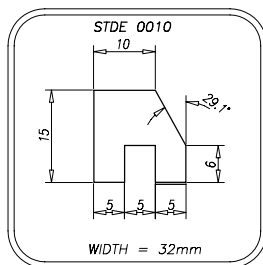
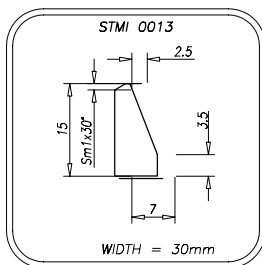
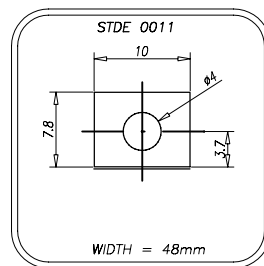
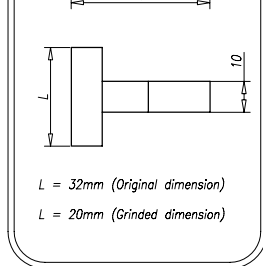
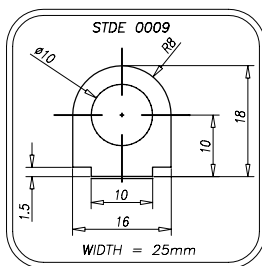
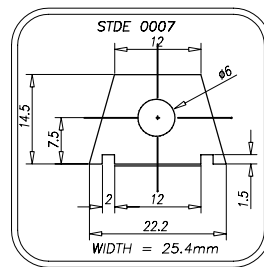
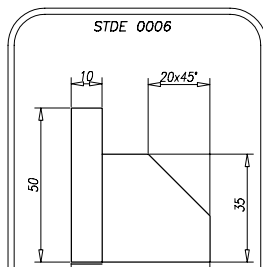
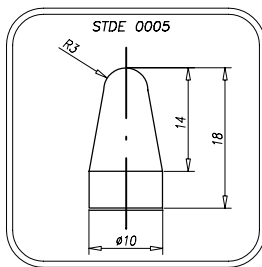
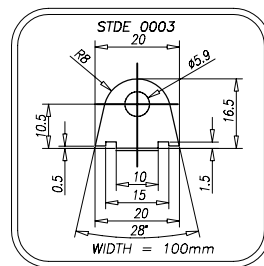
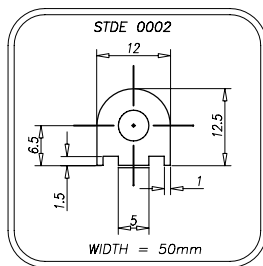
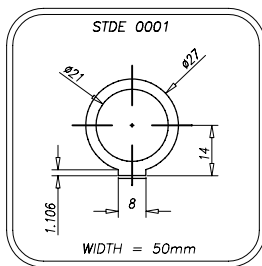



CLEATS

If the needed cleat wouldn't yet present in the following tables, please contact MEGADYNE staff.

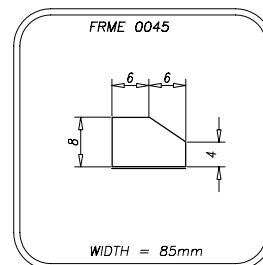
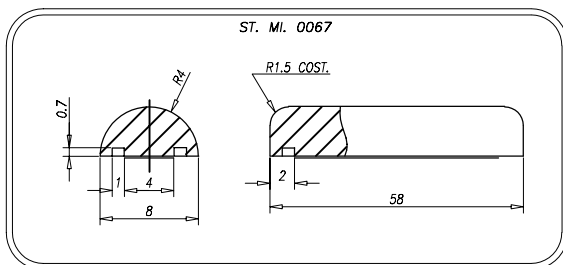
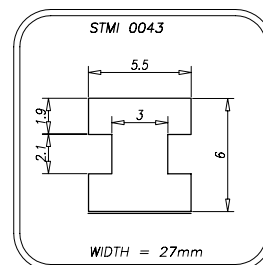
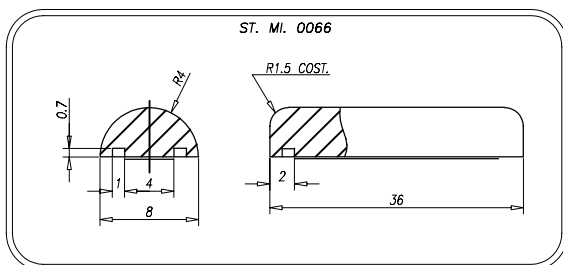
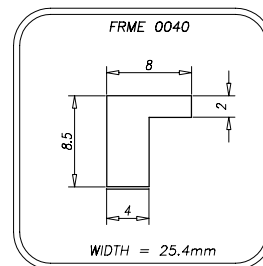
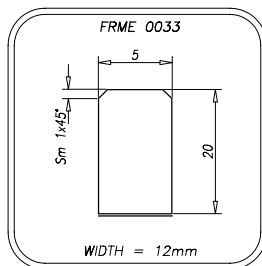
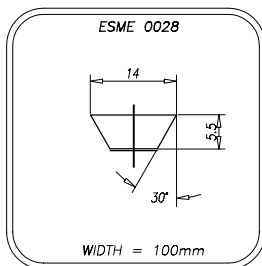
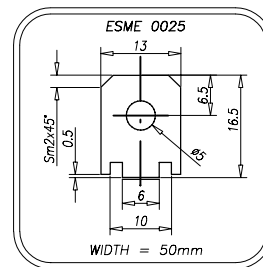
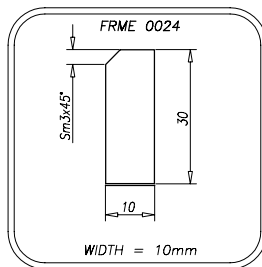
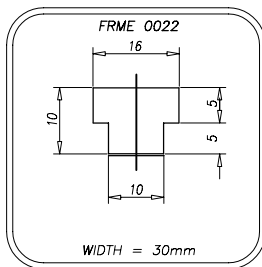
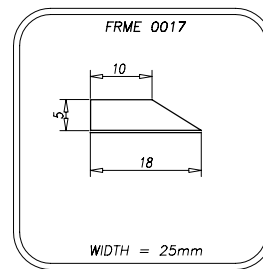
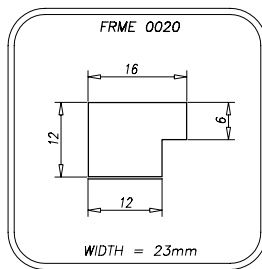
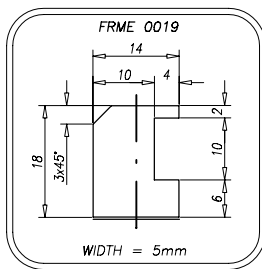



CLEATS

If the needed cleat wouldn't yet present in the following tables, please contact MEGADYNE staff.

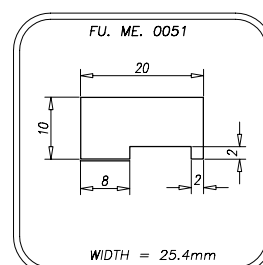
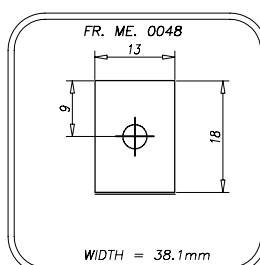
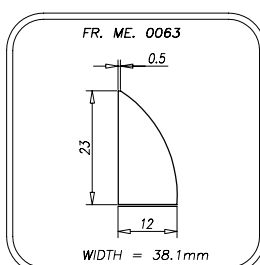
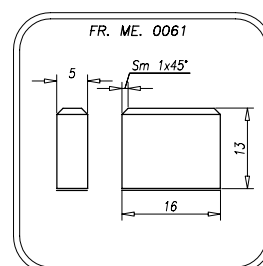
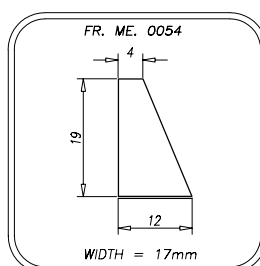
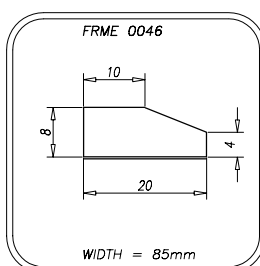
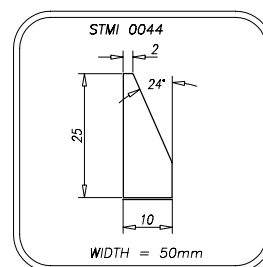
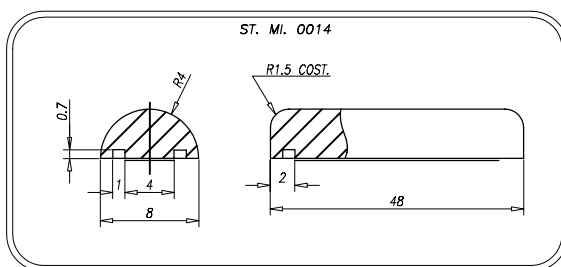
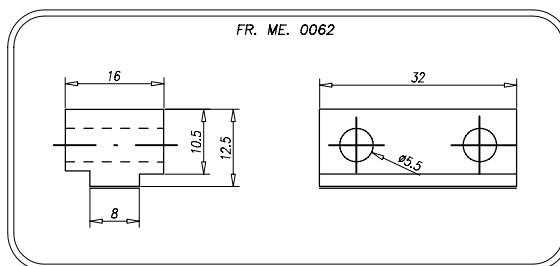
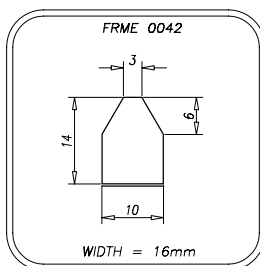
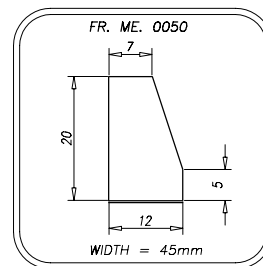
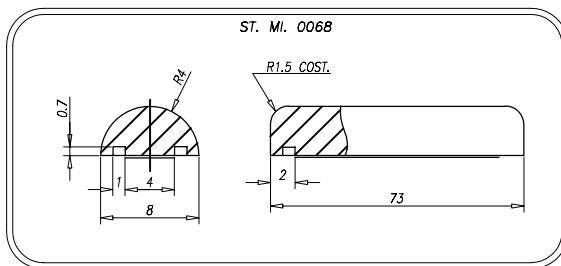



CLEATS

If the needed cleat wouldn't yet present in the following tables, please contact MEGADYNE staff.

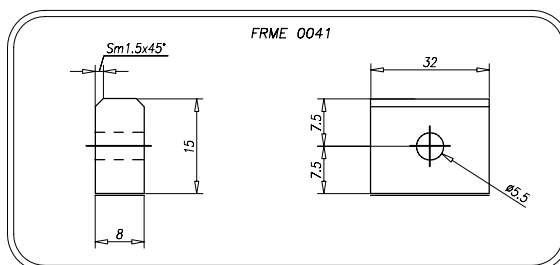
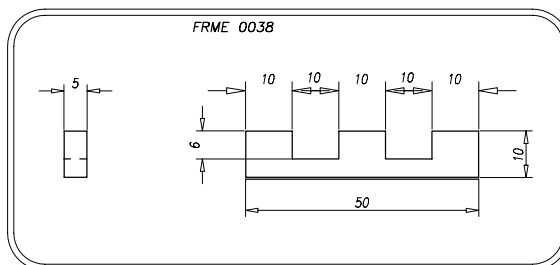
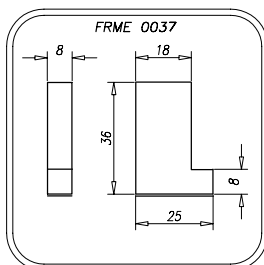
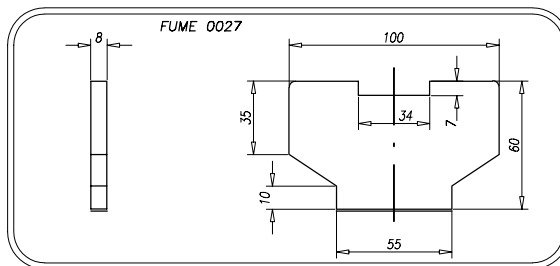
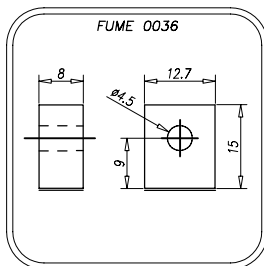
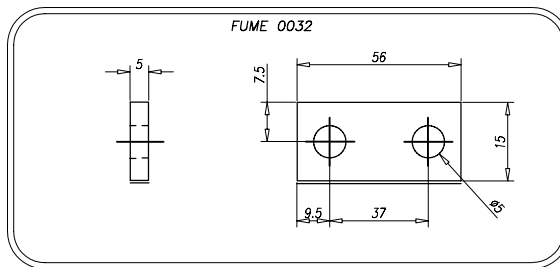
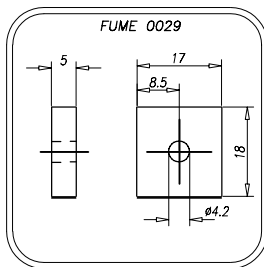
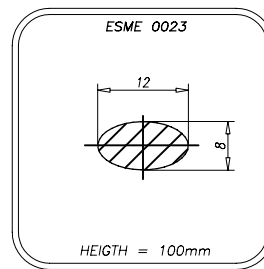
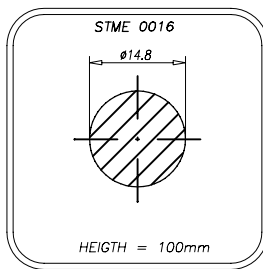
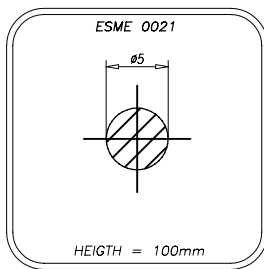



CLEATS

If the needed cleat wouldn't yet present in the following tables, please contact MEGADYNE staff.

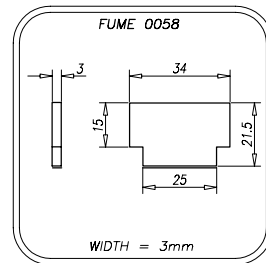
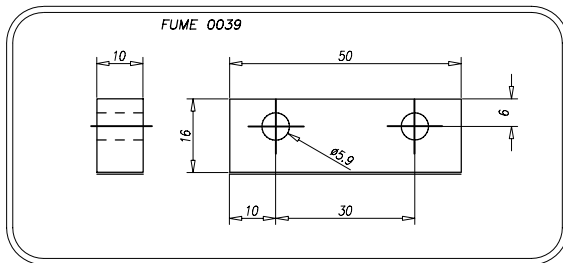
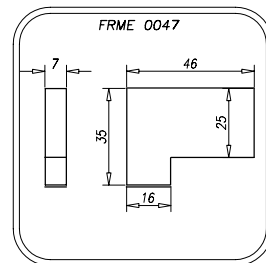
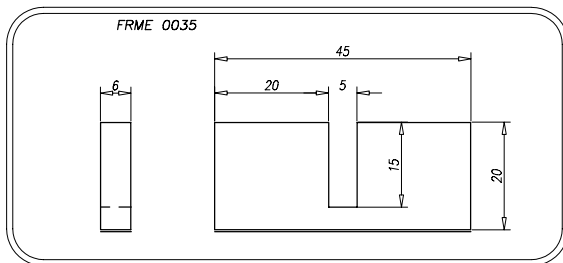
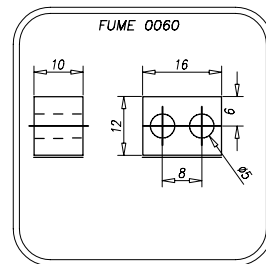
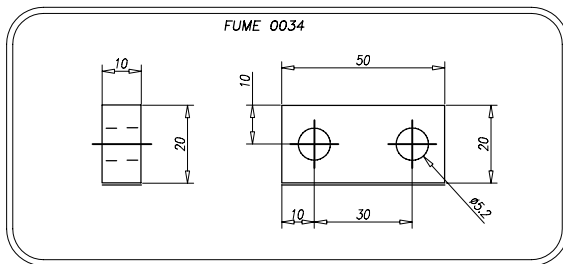
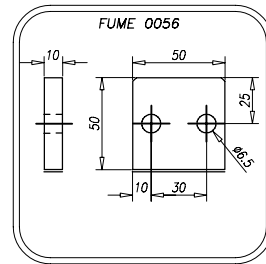
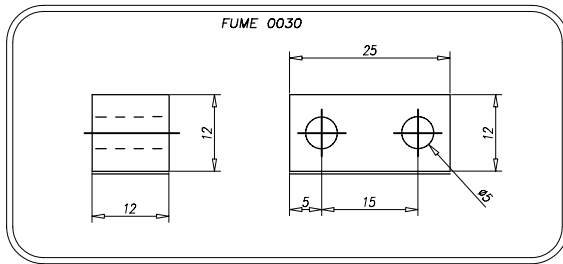
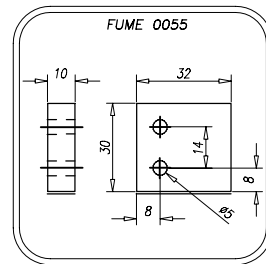
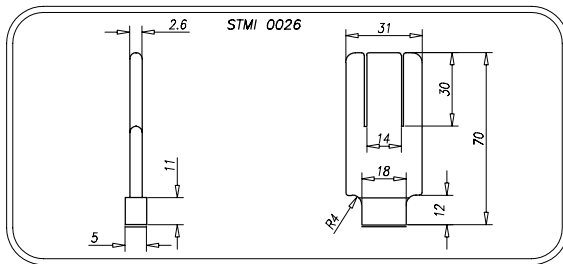



CLEATS

If the needed cleat wouldn't yet present in the following tables, please contact MEGADYNE staff.

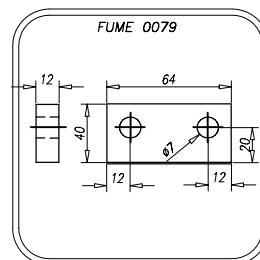
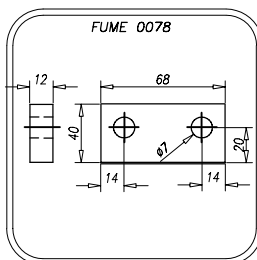
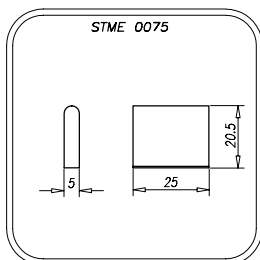
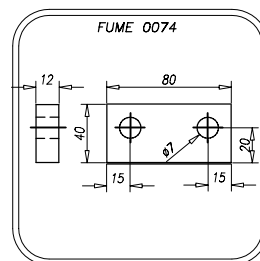
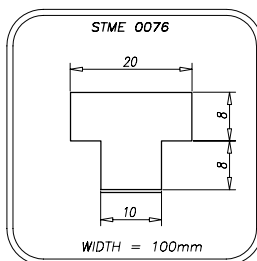
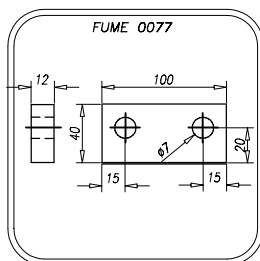
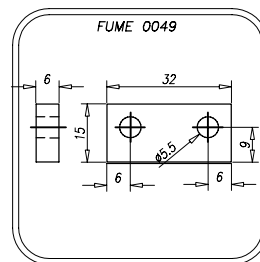
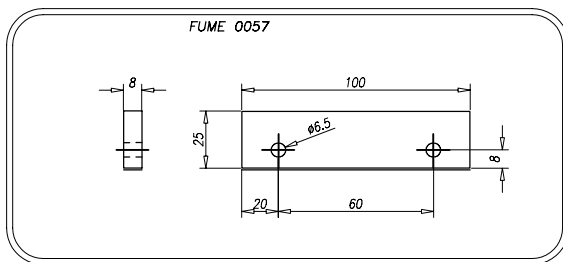
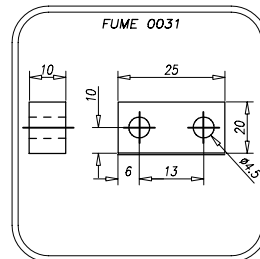
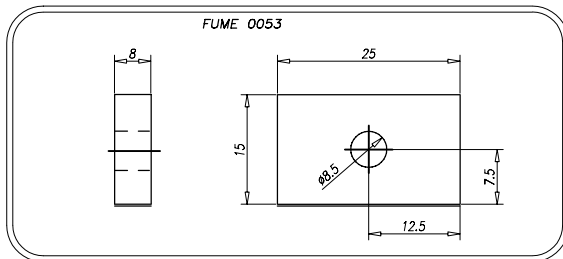
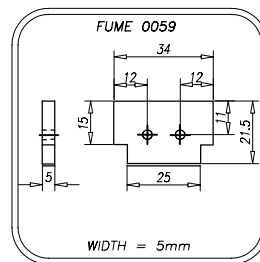
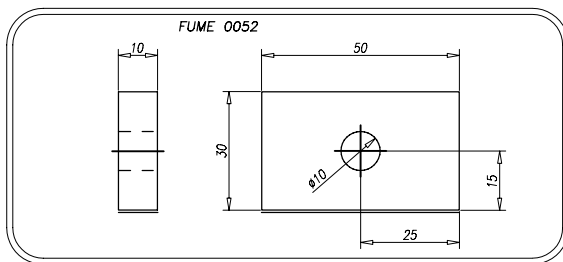



CLEATS

If the needed cleat wouldn't yet present in the following tables, please contact MEGADYNE staff.

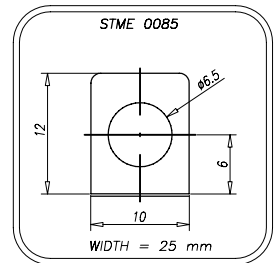
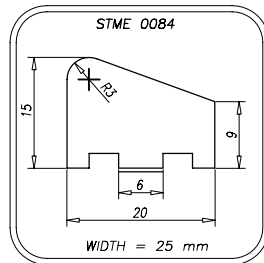
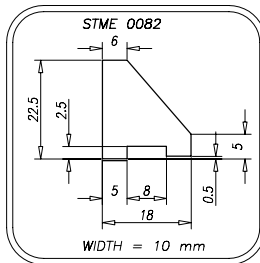
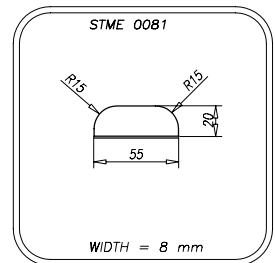
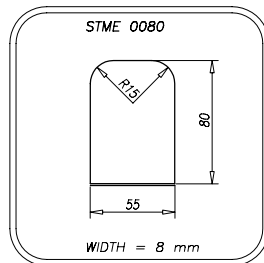
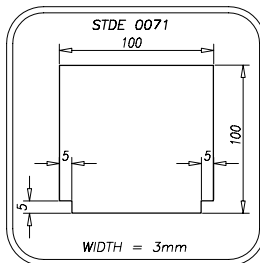
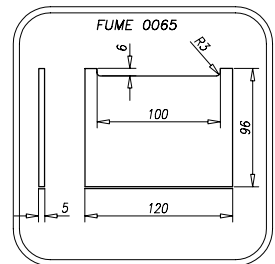
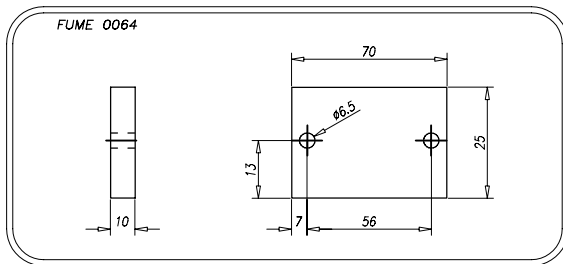
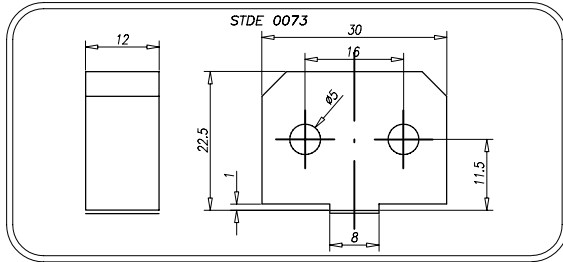
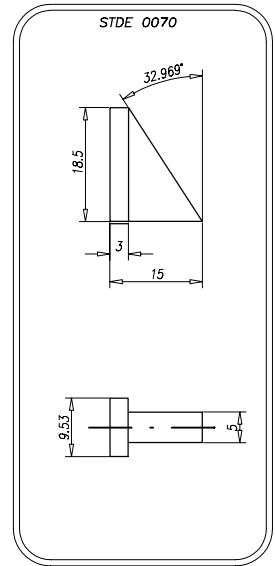
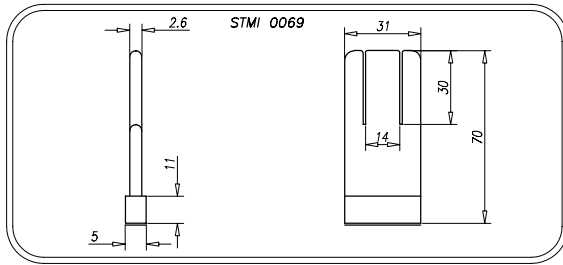



CLEATS

If the needed cleat wouldn't yet present in the following tables, please contact MEGADYNE staff.

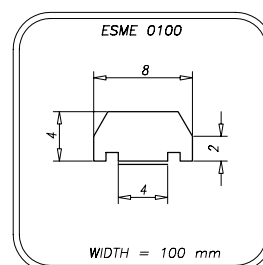
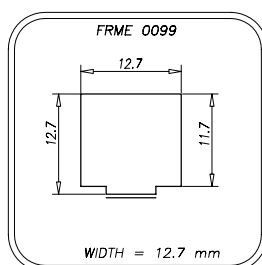
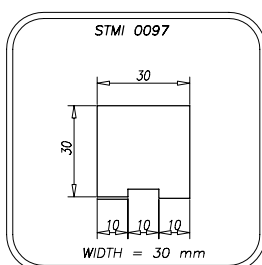
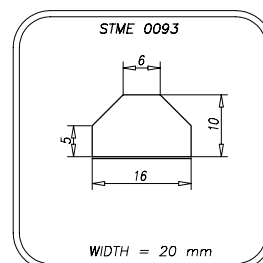
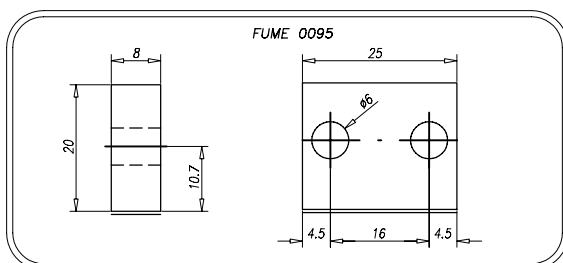
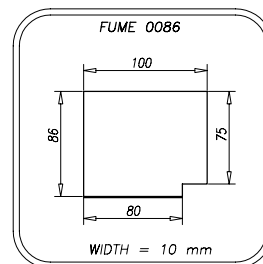
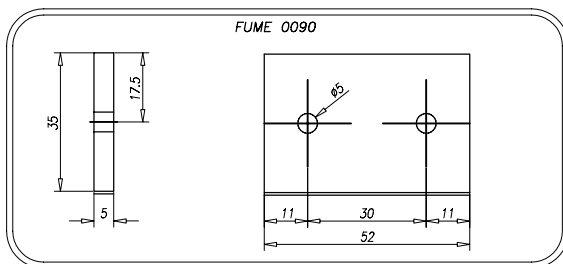
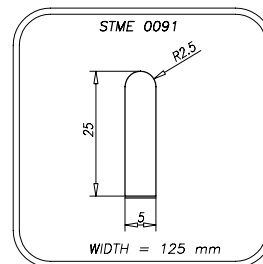
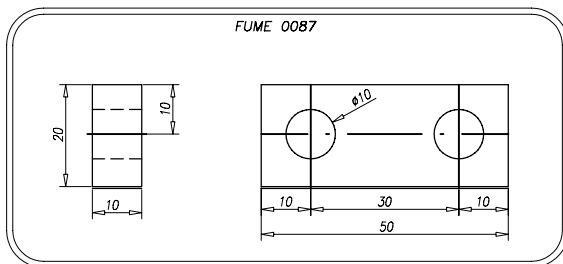
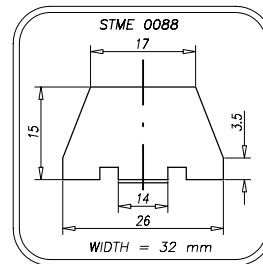
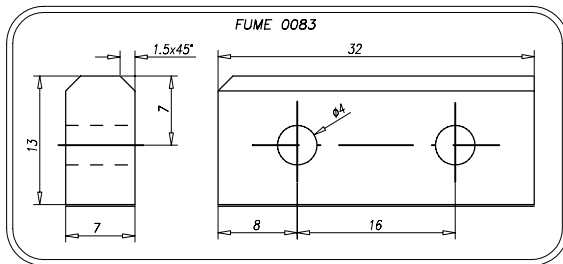



CLEATS

If the needed cleat wouldn't yet present in the following tables, please contact MEGADYNE staff.

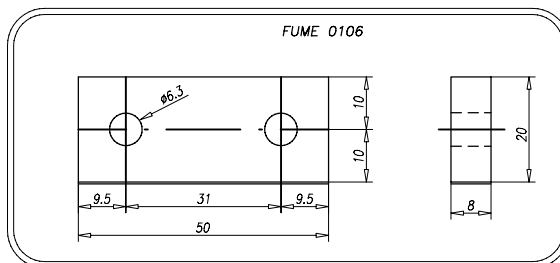
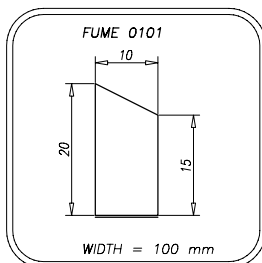
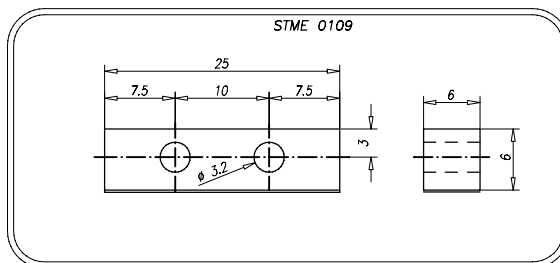
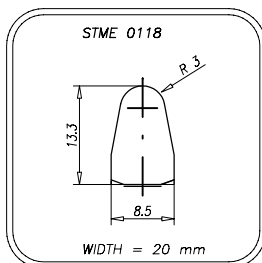
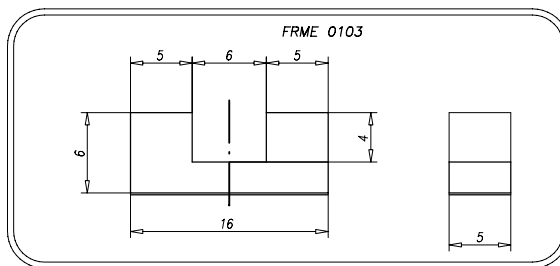
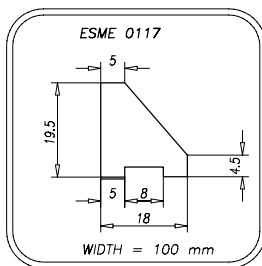
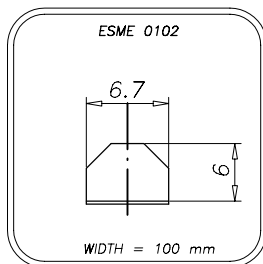
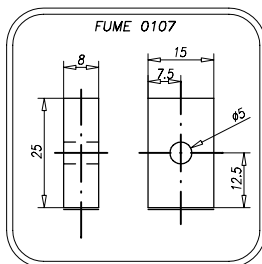
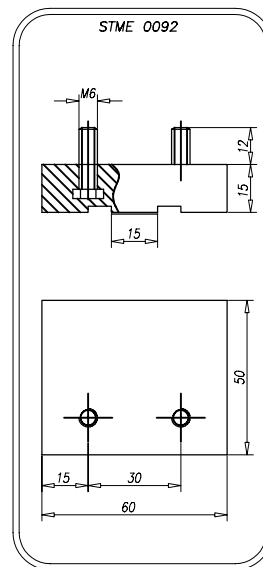
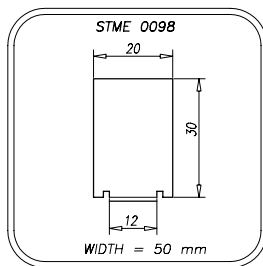
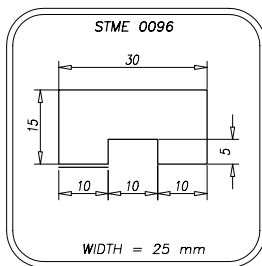



CLEATS

If the needed cleat wouldn't yet present in the following tables, please contact MEGADYNE staff.

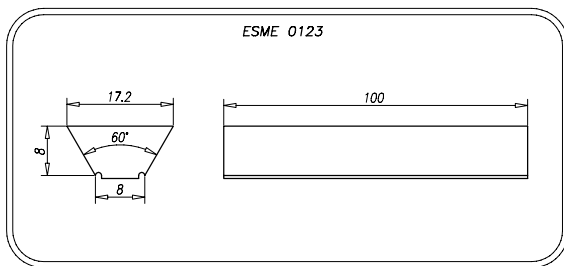
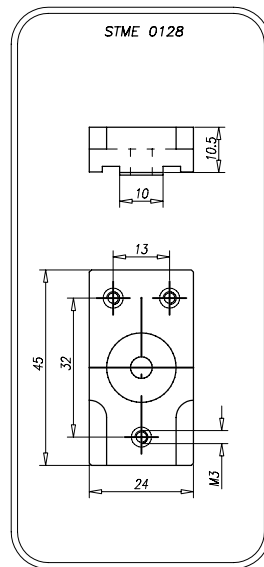
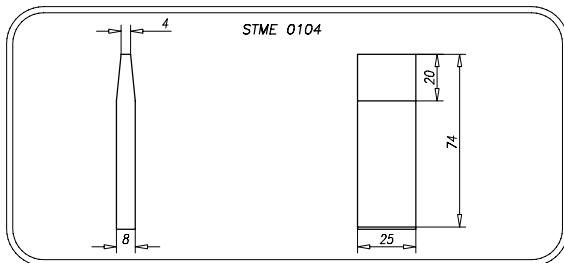
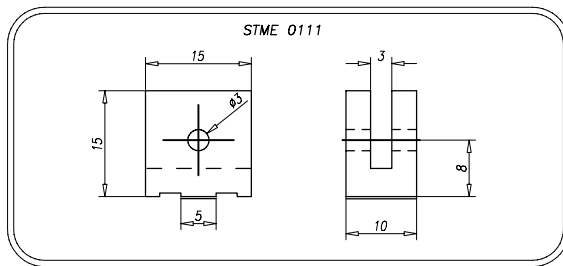
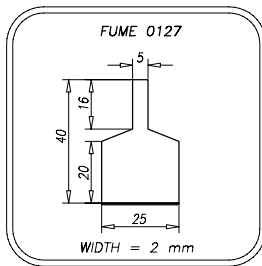
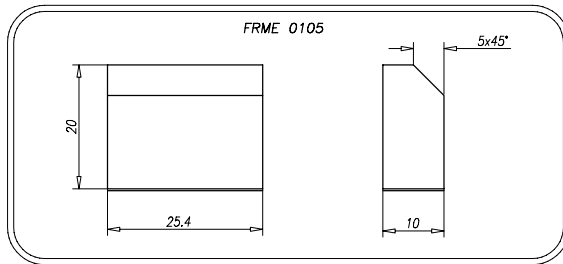
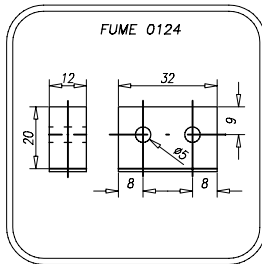
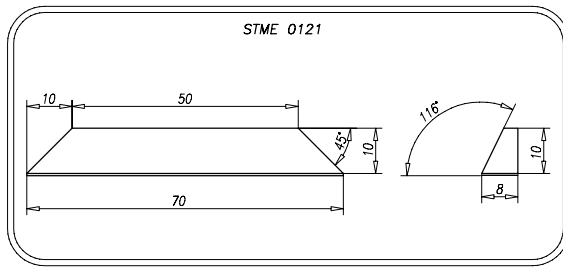
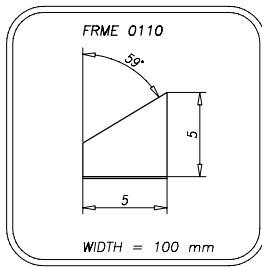



CLEATS

If the needed cleat wouldn't yet present in the following tables, please contact MEGADYNE staff.

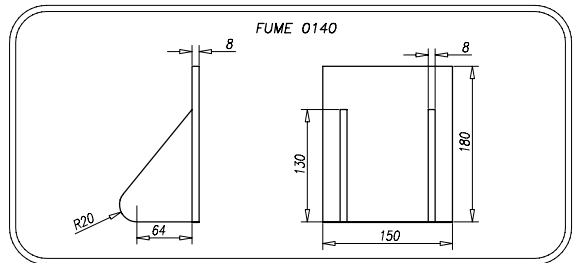
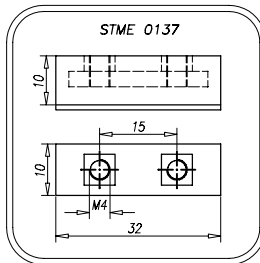
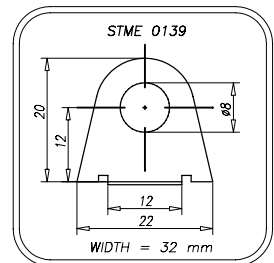
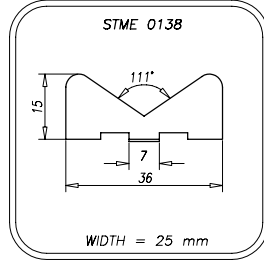
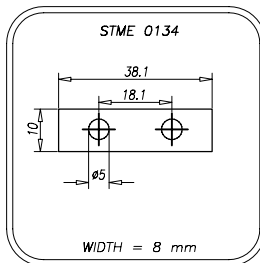
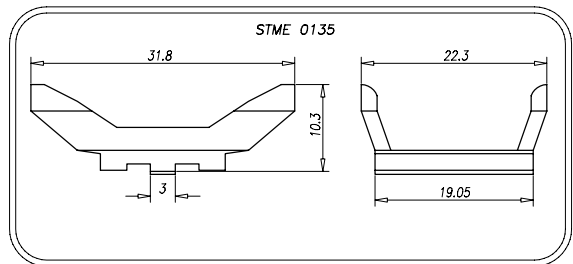
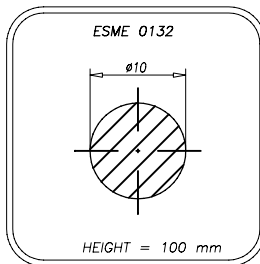
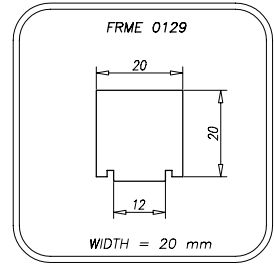
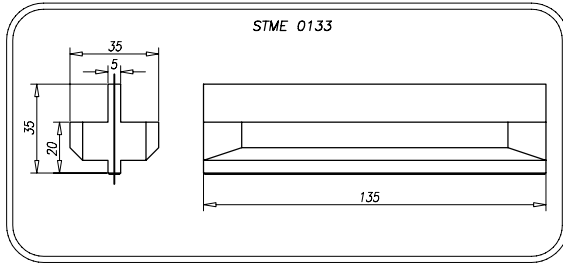
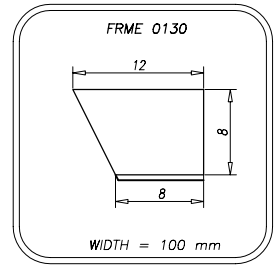
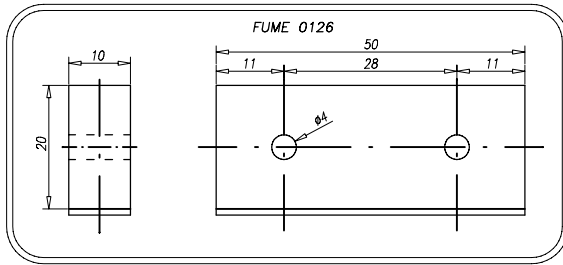



CLEATS

If the needed cleat wouldn't yet present in the following tables, please contact MEGADYNE staff.

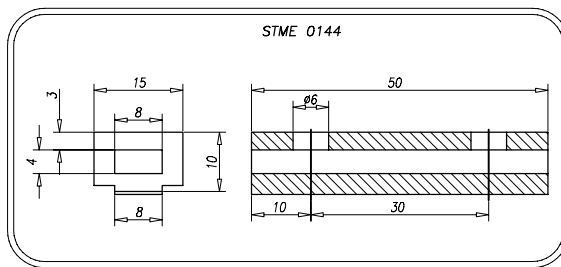
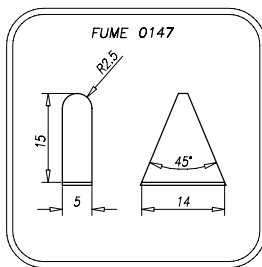
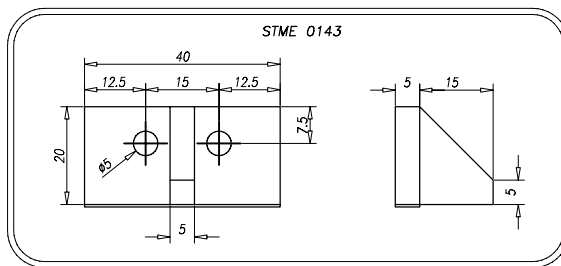
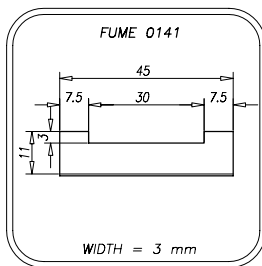

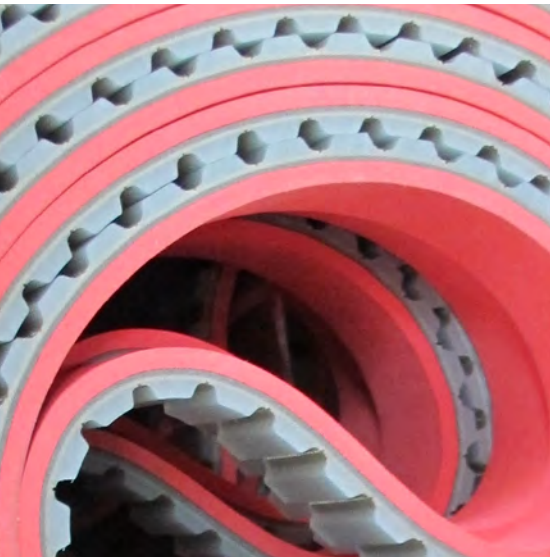

COVER PROPERTIES

MEGALINEAR belt can be coated with several materials. Those coatings are able to suit MEGALINEAR belts to all applications. Main advantages for using coated belts are: reducing noise and modifying friction in conveying materials. Choice of correct coating depends on application field. Megadyne is able to supply extruded coated belt, in this case coating method is same as belt production method and cohesion between belt and cover is guaranteed by welding without using glue.

MEGALINEAR belt can be supplied also with vulcanised or glued cover.

Their technical properties are listed in following tables. Contact Megadyne team for custom solutions.

COVER TYPE									
	NFT/NFB NYLON FABRIC TEETH/ BACK	AVAFC 60	AVAFC 70	AVAFC 85	PU YELLOW, GREY, RED	APL	PU FISHBONE	PU RIBBED	SUPERGRIP PETROL
Raw material	nylon	polyurethane	polyurethane	polyurethane	foamed polyurethane	polyurethane/ PVC	polyurethane	polyurethane	PVC
Hardness (ShA)	–	60	70	85	35-40 50 60-70	55	70	70	46
Colour	green; black (antistatic)	transparent	transparent	transparent	yellow/grey/ red	red	transparent	transparent	petrol green
Coating and belt cohesion method	extrusion lamination	extrusion	extrusion	extrusion	spraying	extrusion	extrusion	extrusion	extrusion lamination
Thickness range (mm)	0,15 - 0,6	2/3/4	2/3/4	2/3/4	1 to 10	3,5	4,3	2,7	4,5
Tolerance on coating thickness	–	+ /- 0,3	+/- 0,3	+/- 0,3	+/- 0,3	+/- 0,3	+/- 0,5	+/- 0,5	+/- 0,5
Working temperature range (°C)	-20 +80	-20 +80	-20 +80	-20 +80	-10 +60	-20 +60	-20 +80	-20 +80	- 10 +60
Friction coefficient ⁽¹⁾	0,25	0,65	0,65	0,60	0,40	0,70	0,60	0,60	0,90
Water resistance	good	good	very good	good	fair	good	very good	very good	good
Abrasion resistance	fair	good	good	very good	very good	good	good	good	fair
Oil resistance	fair	good	fair	good	good	good	fair	fair	good
FDA approved	no	no	no	no	no	no	no	no	no
Min. pulley dia = thickness • ... ⁽²⁾	std pulley	x 40	x 40	x 40	x 25	x 30	x 30	x 35	60 mm

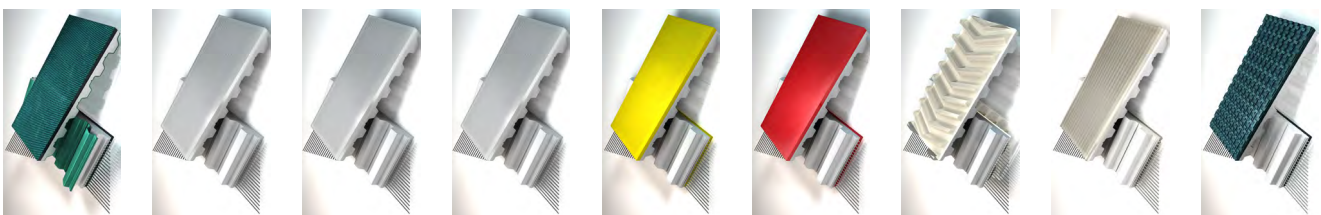

(1) CoF - Determined by the static value against a steel guide; however, consideration must be given to the specific environmental conditions (contamination and/or wear resistance) and aging on the cover.

(2) Pd - Suggested diameter is bigger value between this calculated value and minimum pulley diameter on belt data page.

(*) with add. grinding +/- 0,3 mm possible.



COVER PROPERTIES

COVER TYPE										
HONEYCOMB	LINATEX™	RED NATURAL RUBBER 40	DURATAQ®	TENAX STANDARD	GUMMY CORREX AMBRA PARABLOND	BLACK NEOPRENE	NBR	LINAPLUS FG	POROL BLACK	PVC SAW TOOTH
natural rubber	natural rubber	natural rubber	natural rubber	natural rubber	natural rubber	neoprene	nitrile caoutchouc	natural rubber	natural cellular rubber foam	PVC
50	38 40	40	45	45	48	50 70 (VUC)	50 65-70 (VUC)	38	290 kg/m³	60 +/- 4
red	red	red	orange	red	beige	black	black/white	white	black	white
lamination	lamination; vulcanization	vulcanization	vulcanization	vulcanization	vulcanization	vulcanization; lamination	lamination; vulcanization	lamination	lamination	lamination
4,5 to 15	1 to 10 3 to 12,7 (VUC)	2,4 to 14	2,4 to 14	0,8 to 15	0,8 to 15	3 to 12; 0,8 to 15	2 to 6; 0,8 to 15	1 to 3	2 to 20	2,5
+/- 0,5	+/- 1 (*)	+/- 0,3	+/- 0,3	+/- 0,3	+/- 0,3	+/- 0,3	+/- 0,5 +/- 0,3	+/- 1 (*)	+/- 0,5	+/- 0,5
-20 +60	-40 +70	-20 +80	-20 +100	-20 +60	-20 +60	-20 +60; -10 +100	-35 +70; 0 +120	-40 +70	-40 +70	-15 +70
0,60	0,90	0,50	1,10	0,70	0,60	0,60	0,70 0,60	0,75	1,20	0,70
very good	good	good	good	very good	very good	good	very good ; good	good	very good	good
very good	good	fair	very good	very good	very good	good	poor; good	fair	fair	fair
poor	poor	poor	poor	poor	poor	good	good	poor	fair	very good
no	no	no	no	no	no	no	no	yes	no	yes
x 30	x 20	x 20	x 20	x 30	x 30	x 30	x 30 x 35	x 25	x 15	60 mm

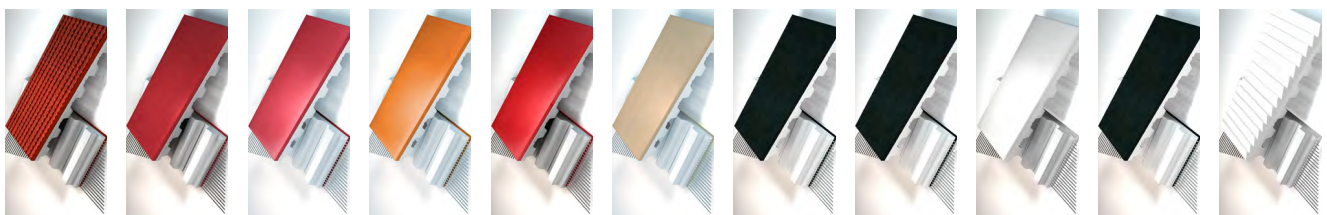



SPECIAL EXECUTION

FEASIBILITY

Megadyne can make special extrusion on customer request to improve belt properties and to suit better to special applications.

SPECIAL POLYURETHANE

On customer request and with minimum quantity, MEGALINEAR belt can be produced with different hardness:

- 85 ShA food quality polyurethane for contact with food and medical products
- 92 ShA higher resistance to temperature
- 92 ShA silicon free for painting system based on water
- 95 ShA glass reinforced
- 98 ShA extra hard polyurethane

COLOUR

On customer request and with a minimum quantity is possible to produce MEGALINEAR with several colours.

Different colour doesn't influence belt technical properties so mechanical features are same as standard white belt.

Available colours are: • White • Black • Blue • Yellow • Transparent

SPECIAL EXTRUSION

On customer request, Megadyne R&D department can develop special extruded belts by designing special mould.

It is also possible to extrude standard belt with special cords position, ready for successive reworkings.

MECHANICAL REWORK

Megadyne have been producing specialized belting for many years. Our in-house facilities enable us to produce belt with special holes for vacuum conveyors, belts with special backings / ground finishes for high tolerance applications. We can remove individual teeth and perforate the timing belt as required.

BACK GRINDING

A belt back can be ground to achieve a precise belt thickness as an adjunct to precision drives. When belt back grinding to a tolerance is required, the total thickness, including the tooth, must be specified. A grinding tolerance of ± 0.2 mm is achievable with a level finish (i.e. thickness will not vary greatly around the belt). Most widths and lengths are available.

LONGITUDINAL REWORK

Longitudinal rework along the belt back is possible on covered and uncovered belts. The profile can be machined precisely for required function. The measurement is given as the depth on the belt back. Most widths and lengths are available.

REWORK ON BELT TEETH

The rework of the tooth profile can be very useful, i.e. improving the steering effect with guide rails. The rework dimension is given from the top of the tooth. Most belt widths and lengths are available.

SPECIAL EXECUTION



HOLES IN TIMING BELTS

Holes in timing belts can be for vacuum or air film conveying or as clearance for assembly mechanisms. Stops and cams can be attached through the holes. Customized tooling may be required depending on the layout and dimensions of holes required.

SINGLE TOOTH REMOVAL

Single and multiple tooth removal is available to your requirement, for applications in handling and conveying technology.

MEGALINEAR FCM

On customer request and with minimum quantity, it is possible to produce MEGALINEAR belts approved and certified for direct contact with dry and wet food according to EC 10/2011 and EC 1934/2004 regulations, and limited to the following configuration:

- 92 ± 4 ShA special grade polyurethane, sky blue colour (RAL 5012 reference)
- Stainless steel cord insert only
- NFT\NFB fabric and covers options NOT available
- Available Range: T5-T10-T20-AT5-AT10-AT20-H-STD8-ATG10

MEGALINEAR XMD

Available in all standard profiles and lengths already in use for MEGALINEAR FC, MEGALINEAR FCM.

CHARACTERISTICS:

- Special detectable dark blue polyurethane compound
- Standard cords: S and Z torsion Kevlar for MEGALINEAR FC; Stainless steel for Megaflex FCM and MEGALINEAR FCM
- Standard splice method by finger splice
- Customizable with cleats, made of the same detectable thermoplastic compound and applied by welding.

FEATURES:

- Metal and X-Ray detectable thermoplastic compound for belts and cleats
- Easy switch 1:1 with existing timing belts
- Food Grade belts comply with EC 1935/2004, EU 10/2011, and FDA standards that support ISO 22000 (previously HACCP) requirements
- Working temperature -25°C/+70°C.

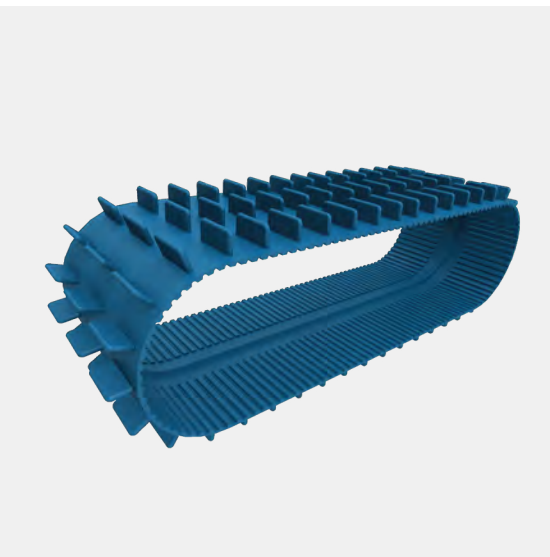

XMD METAL DETECTABLE
& X-RAY

SPECIAL EXECUTION

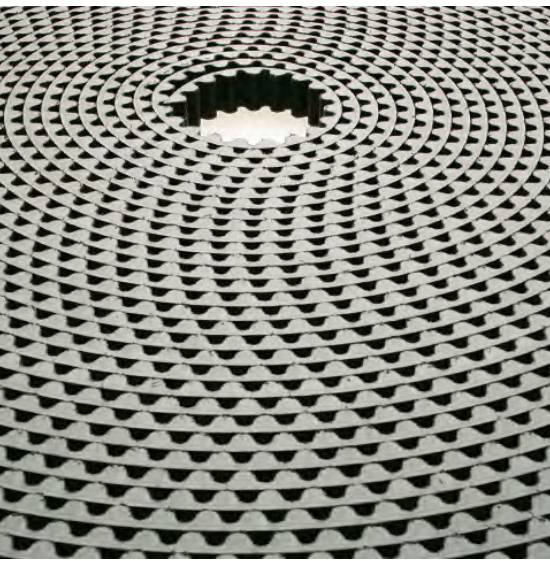

ANTISTATIC POLYURETHANE TIMING BELTS

Megadyne offers antistatic belts. Under certain conditions, a polyurethane belt may build-up a significant static electric charge. For applications where belts are intended for operation in a potentially explosive atmosphere or near electrical components, polyurethane belts should be sufficiently conductive to dissipate this electrical charge. Belts can be constructed (using proper nylon fabric coating) with a relatively low electrical resistance characteristic and are typically referred to as “static conductive” surface or “antistatic” surface. The test methods for determining the surface resistive properties of a belt are based on ISO 9563, “Belt Drives - Electrical Conductivity of Anti-static Endless Synchronous Belts - Characteristics and Test Method”. To be antistatic the electrical resistance, in ohms, of a belt measured in accordance with test method of norm ISO 9563, should not exceed:

$$\text{Resistance} = \Omega = \frac{(6 \cdot 10^5) \cdot L}{W}$$

WHERE:

L = is dry distance between electrodes (7 grooves, 6 teeth between contacts)

W = is the width of the belt

L and W are expressed in the same units (mm or inches).

Megadyne antistatic belts are produced with black polyurethane as standard.

TYPICAL APPLICATIONS

- Conveyance of PC boards or other electronic assemblies
- Semiconductor processing
- Conveying munitions of explosive detonators
- Paper conveying
- Power transmission applications in textile industries
- Chemical environment power transmission or conveying
- Clean room conveyors and power transmissions

SPECIAL EXECUTION

PHOTOS

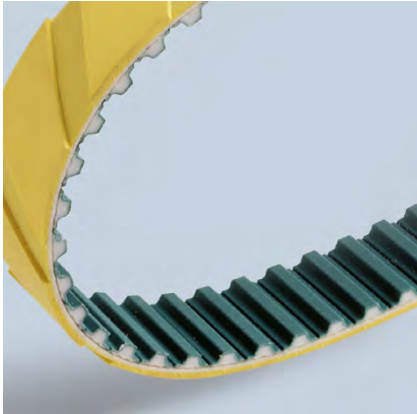

GLASS INDUSTRY

Coating and special grinding on the back allow Megadyne belt to be suitable to all customer applications

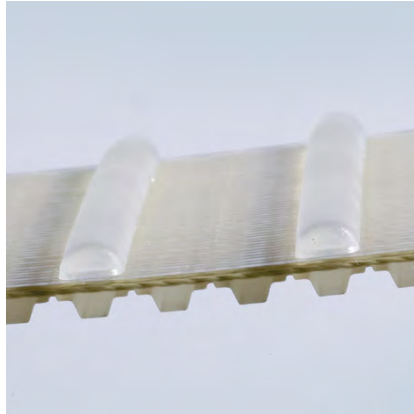

TOBACCO INDUSTRY

Belt with special cleats for tobacco industry

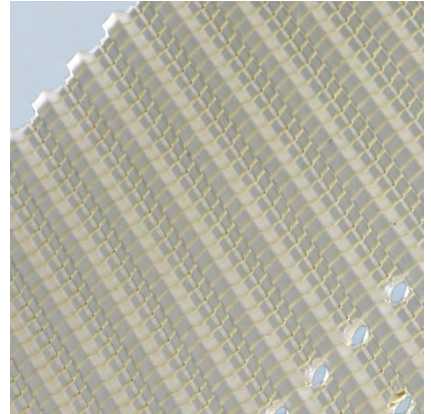

NAPPY INDUSTRY

Wide extruded belt for nappy industry



PACKAGING INDUSTRY

Special reworking to install custom made elements



AUTOMOTIVE INDUSTRY

Belt suitable to convey steel coils and plates due to guides on the back



PAPER INDUSTRY

Special extruded belt for vacuum conveyor application in paper industry



CARTON INDUSTRY

New extruded belt for vacuum application in carton conveyor industry



CONVEYOR APPLICATION

Special coating for conveyor application

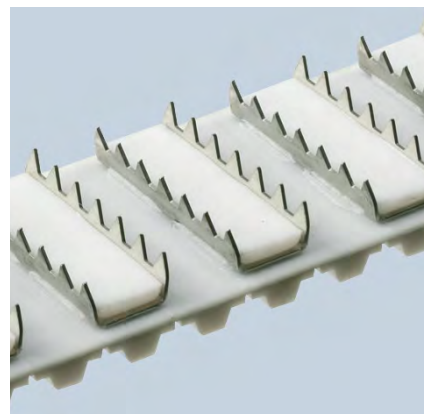

FISH INDUSTRY

High variety of cleats allow MEGALINEAR belts to work in several fields

DATA SHEET

CUSTOMER DATA

Company Name _____ Date _____

Address _____ Zip Code _____

City _____ State _____ Country _____

Customer Name/Surname _____

Office _____ Tel. _____ e-mail _____

DRIVE INFORMATION TRANSMISSION LAYOUT

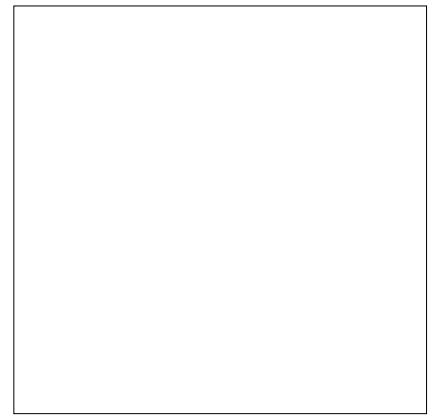
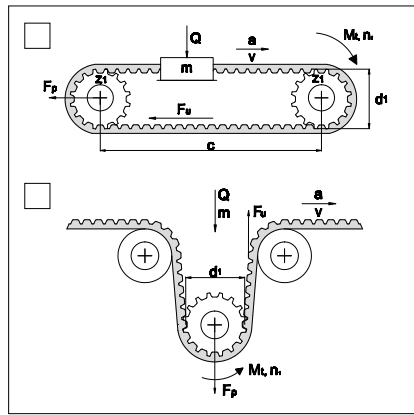
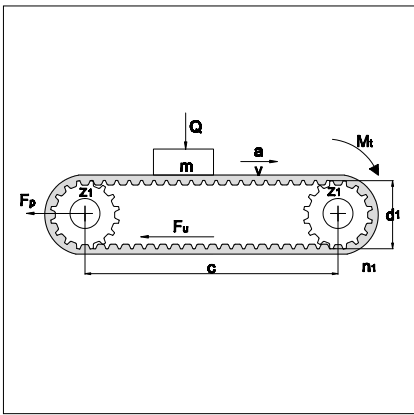

Conveyor

Linear motion (choose between the layout above)

Other (If layout is different please sketch it above)

DRIVE INFORMATION (FOR CONVEYOR)

Driver pulley's diameter _____ Driven pulley's diameter _____

Center distance _____ Minimum safety factor needed _____

Are there any size limitation? Yes No

(if yes, please indicate *Max diameter*, *Max width* and *Max center distance*):

Max diameter _____ Max width _____ Max center distance _____

Linear speed _____ Acceleration _____ Mass _____

Is there any sliding surface? Yes No (if yes please indicate friction coefficient): _____

Is there any cover on the back? Yes No (if yes please indicate the type) _____

Are cleats required? Yes No (if yes please indicate cleats code, otherwise attach drawings) _____

Working time < 8h From 8h up to 16h 24h

DATA SHEET

DRIVE INFORMATION (FOR LINEAR MOTION)

Driver pulley's diameter _____ Driven pulley's diameter _____

Center distance _____ Minimum safety factor needed _____

Are there any size limitation? Yes No

(if yes, please indicate *Max diameter*, *Max width* and *Max center distance*):

Max diameter _____ Max width _____ Max center distance _____

Linear speed _____ Acceleration _____ Mass _____

Working time < 8h From 8h up to 16h 24h

WORK'S ENVIRONMENT INFORMATION (FOR ALL LAYOUT TRANSMISSION SYSTEM)

Work Temperature (please indicate constant temperature and in case peaks) _____

Humidity Standard No standard Other _____

Chemical agents: (oils, grass, aggressive compounds) Yes No

In case please indicate type and percentage _____

DATA SHEET

CUSTOMER DATA

Company Name _____ Date _____
 Address _____ Zip Code _____
 City _____ State _____ Country _____
 Customer Name/Surname _____
 Office _____ Tel. _____ e-mail _____

DRIVE INFORMATION TRANSMISSION LAYOUT

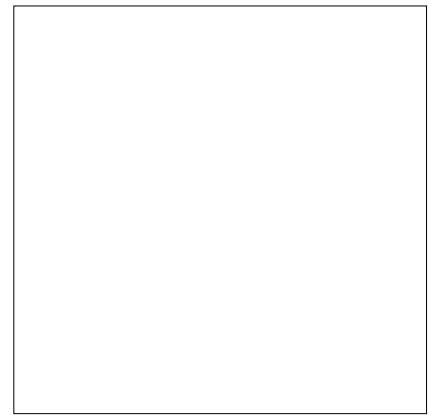
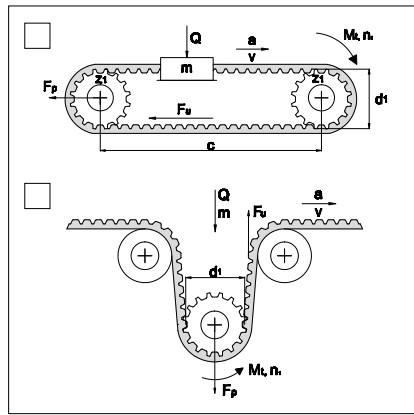
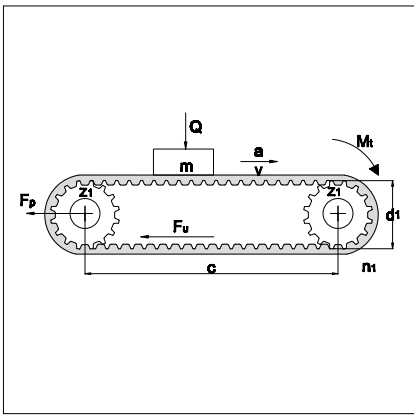

- Conveyor Linear motion (choose between the layout above) Other (If layout is different please sketch it above)

DRIVE INFORMATION (FOR CONVEYOR)

Driver pulley's diameter _____ Driven pulley's diameter _____

Center distance _____ Minimum safety factor needed _____

Are there any size limitation? Yes No

(if yes, please indicate *Max diameter*, *Max width* and *Max center distance*):

Max diameter _____ Max width _____ Max center distance _____

Linear speed _____ Acceleration _____ Mass _____

Is there any sliding surface? Yes No (if yes please indicate friction coefficient): _____

Is there any cover on the back? Yes No (if yes please indicate the type) _____

Are cleats required? Yes No (if yes please indicate cleats code, otherwise attach drawings) _____

Working time < 8h From 8h up to 16h 24h

DATA SHEET

DRIVE INFORMATION (FOR LINEAR MOTION)

Driver pulley's diameter _____ Driven pulley's diameter _____

Center distance _____ Minimum safety factor needed _____

Are there any size limitation? Yes No

(if yes, please indicate *Max diameter*, *Max width* and *Max center distance*):

Max diameter _____ Max width _____ Max center distance _____

Linear speed _____ Acceleration _____ Mass _____

Working time < 8h From 8h up to 16h 24h

WORK'S ENVIRONMENT INFORMATION (FOR ALL LAYOUT TRANSMISSION SYSTEM)

Work Temperature (please indicate constant temperature and in case peaks) _____

Humidity Standard No standard Other _____

Chemical agents: (oils, grass, aggressive compounds) Yes No

In case please indicate type and percentage _____

The data and information contained in the present catalogue are updated to the date of the catalogue's printing. Ammega Italia S.p.A. reserves the right to modify the specifications, performances and other information relating to the belts described in the present catalogue, at any time at its own discretion, without any prior notice.

For updating refer to our website www.megadynegroup.com.

Technical specifications, performances and other information provided in the present catalogue are indicative and do not bound Ammega Italia S.p.A. unless such specifications, performances or other information are expressly agreed in the agreement with the customer.

We also recommend to read carefully the following documents on our website www.megadynegroup.com:

- Ammega Italia S.p.A. General Conditions of Sale (comprising the warranty)
- Theoretical Belt Life
- Drive Components: Storage, Installation, Maintenance and Troubleshooting Handbook
- Belts standard use condition and temperature.

Copyright Notice: Ammega Italia S.p.A. copyright. All rights reserved.

Ammega Italia S.p.A. is and shall remain the owner of all rights on drawings, technical specifications and any other information contained in the present catalogue or otherwise communicated by Ammega Italia S.p.A. to the customer.

The customer shall not disclose such information to third parties or use such information for purposes different from the definition of the order to Ammega Italia S.p.A., unless upon prior written authorization of Ammega Italia S.p.A.



Ammega Italia S.p.A.
ITALY - MATHI

Discover Your Local Contacts

The local partner of choice
for sustainable power transmission belting solutions
around the globe.

General contact information:

Megadyne

Via Trieste, 16
Via S. Lucia 114 - 10075 Mathi (Torino)
Italy



Scan the QR code
and find your local
contact

megadynegroup.com/en/contact-us

